

# ICAD Model Configuration Guide

## INTRODUCTION

The ICAD instrument series is highly modular. The flow-charts in this document are meant to help you finding the exact configuration to best meet your individual requirements and guide you through the ordering process.

1. Use page 2 & 3 to identify the basic system type. Click on the instrument symbol or turn over to the indicated page to continue with the corresponding sub-chart.
2. Follow the arrows in the sub-chart from top to bottom. On the way you come across the names of all relevant articles. Articles and detailed description for each article can be found in the price list and data sheets. Not all Articles are listed in the flow-charts. Further, the meaning of the symbols is as follows:

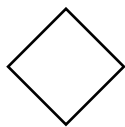

**Branching. A decision is required here.**

If unsure, check the comments in the price list or the ICAD datasheets for details.

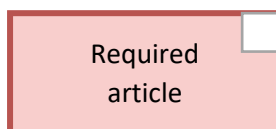

Required  
article

**Rectangles represent actual articles. Colour indicates their necessity (see captions on the left).**



Recommended  
article

When coming across articles to be ordered, gather them on a list or mark them using the checkboxes on the upper right of the rectangle. Checkboxes of required articles are marked by default.



Optional  
article

## Application

## Required instrument

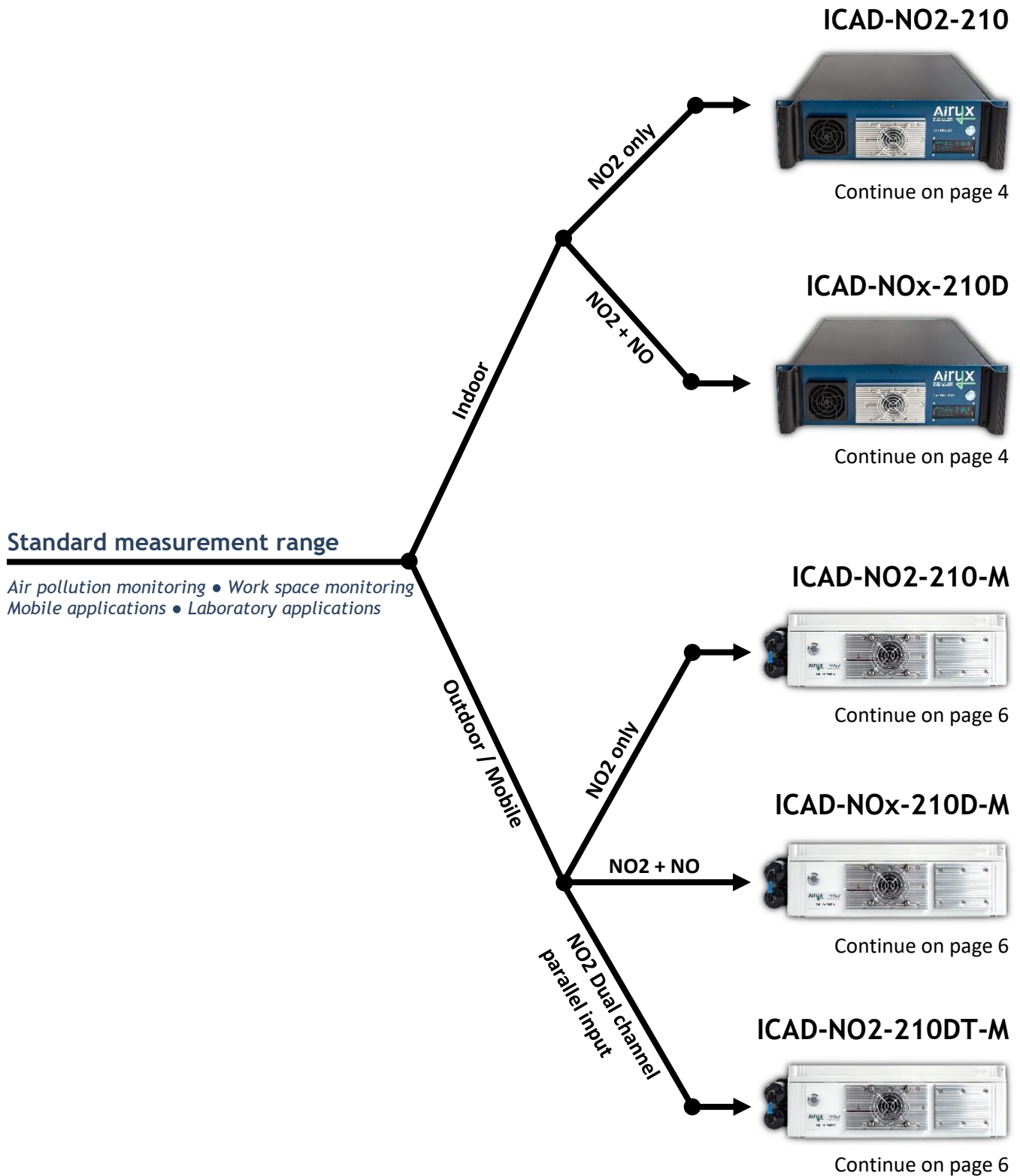

**ICAD-NO2-210L**



Continue on page 8

**ICAD-NOx-210DL**



Continue on page 8

**ICAD-HONO/NO2-210DL**



Continue on page 8

**ICAD-NOx-210DE**



Continue on page 10

**ICAD-NOx-210DE-M**



Continue on page 10

**ICAD Custom**



**Scientific grade precision**

Very low concentrations / High sensitivity  
Air quality monitoring • Atmospheric science  
Laboratory applications

NO<sub>2</sub> only

NO<sub>2</sub> + NO

HONO + NO<sub>2</sub>

**Simultaneous NOx and CO<sub>2</sub> measurements**

Vehicle emissions • Plume chasing  
Ship emissions

Indoor

19" Rack housing

Outdoor

Ensto housing

**Customized Instruments**

UAV or other custom solutions  
Light weight / Compact / Low power consumption

# Standard Measurement Range Indoor Use

INSTRUMENT TYPE

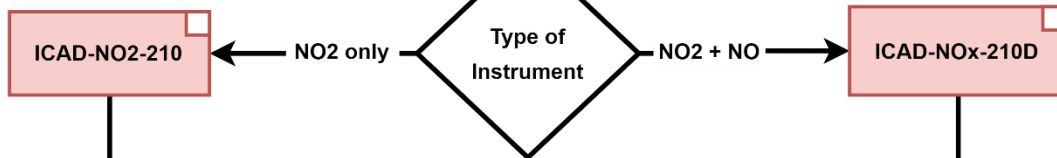

INSTRUMENT CONFIGURATION

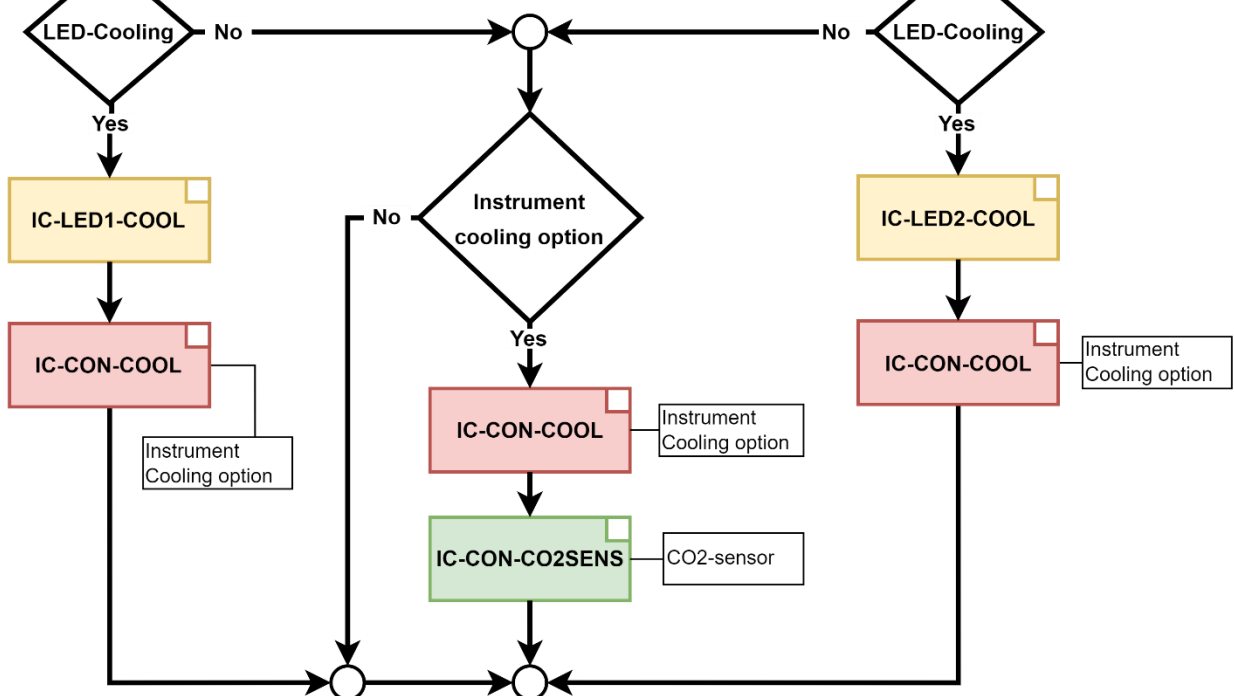

EXTENSIONS AND ACCESSORIES

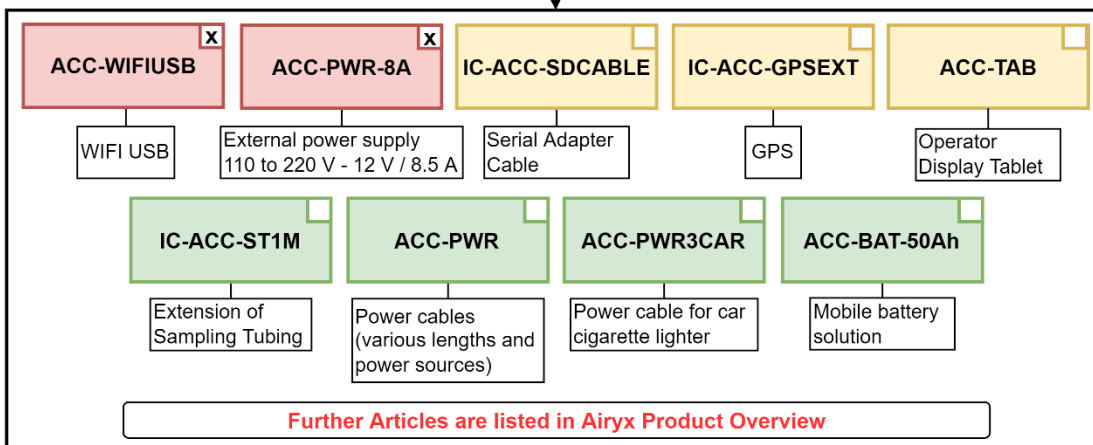

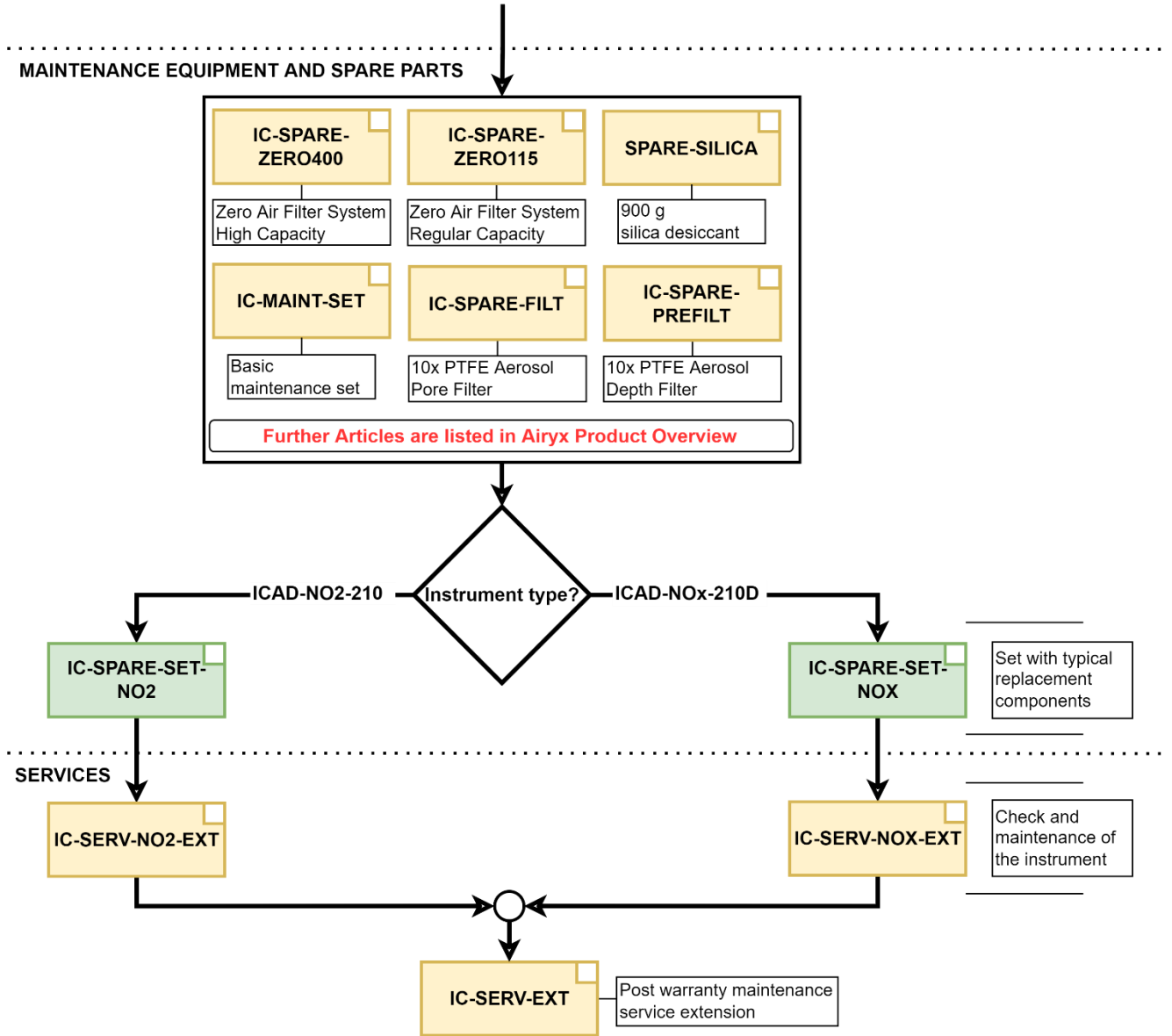

# Standard Measurement Range *Outdoor Use*

INSTRUMENT TYPE

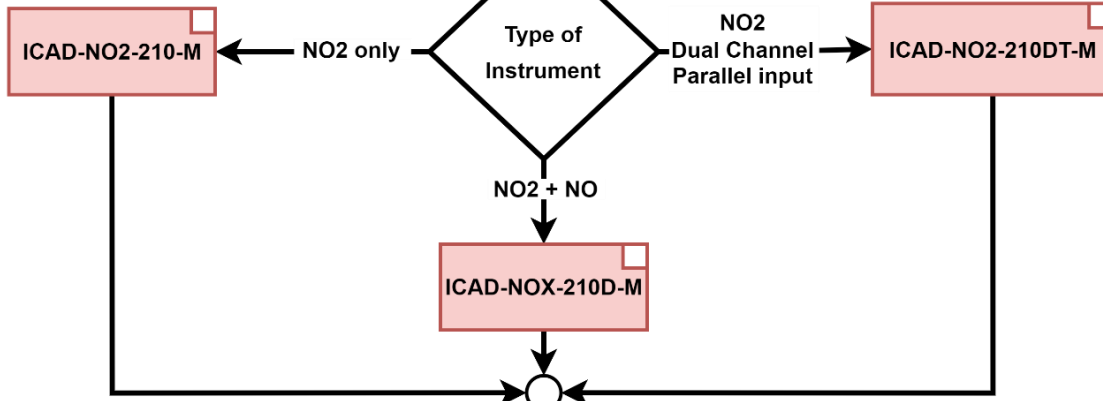

INSTRUMENT CONFIGURATION

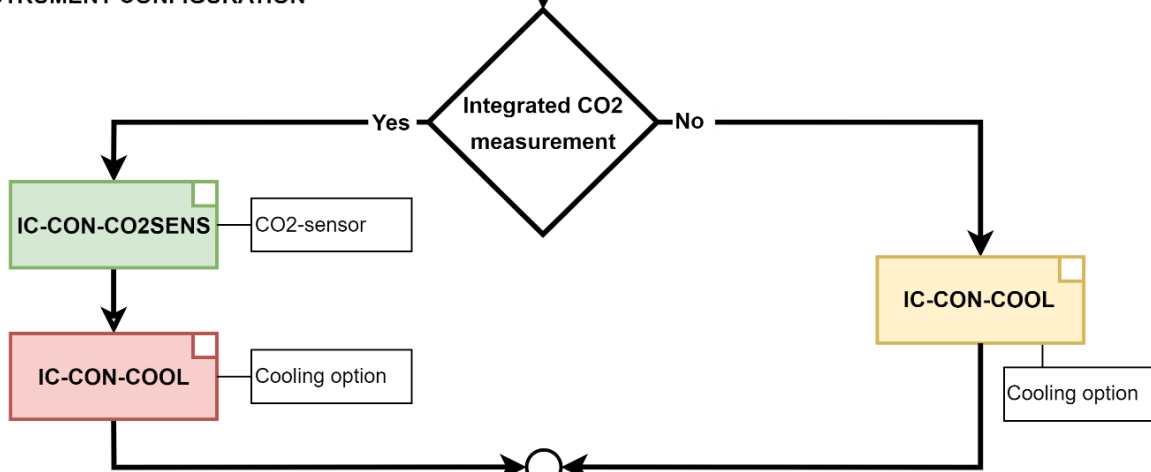

EXTENSIONS AND ACCESSORIES

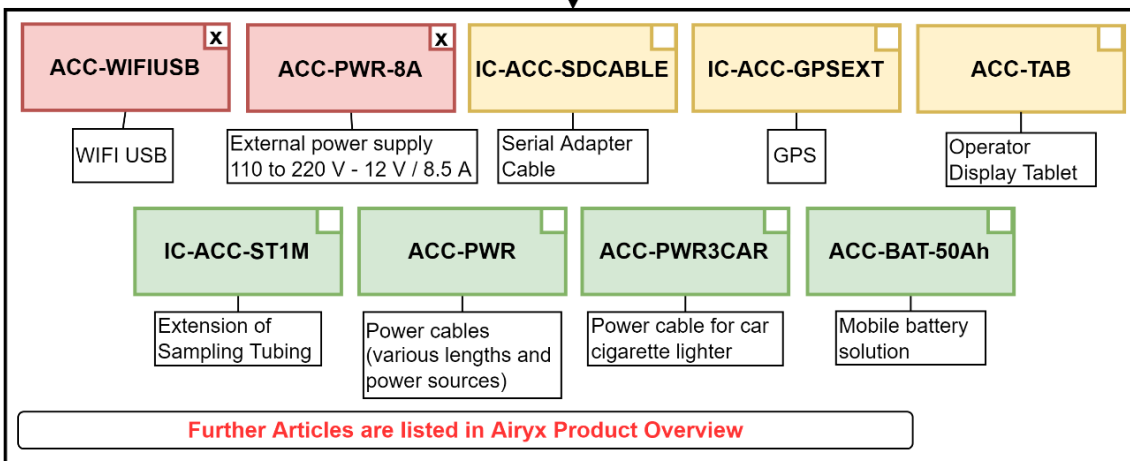

MAINTENANCE EQUIPMENT AND SPARE PARTS

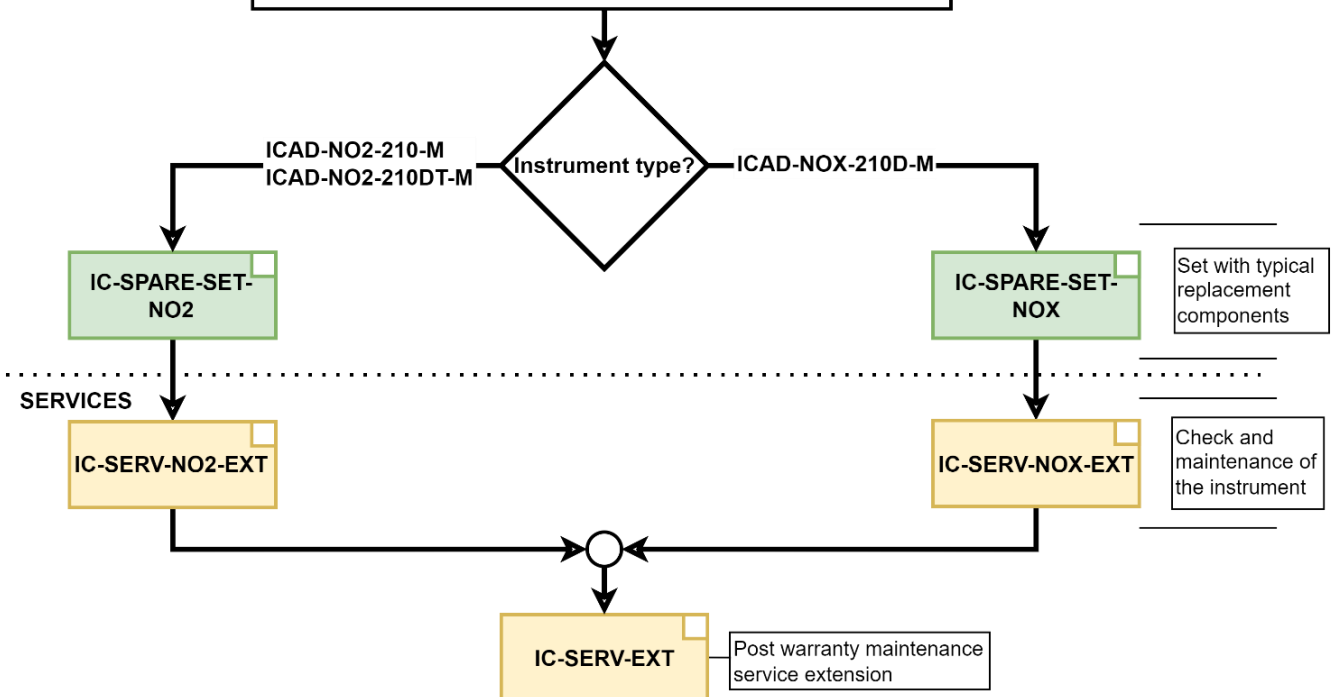
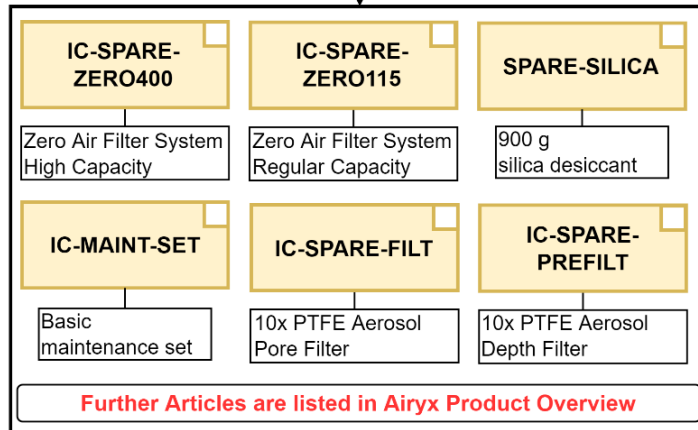

# Scientific Grade Precision

INSTRUMENT TYPE

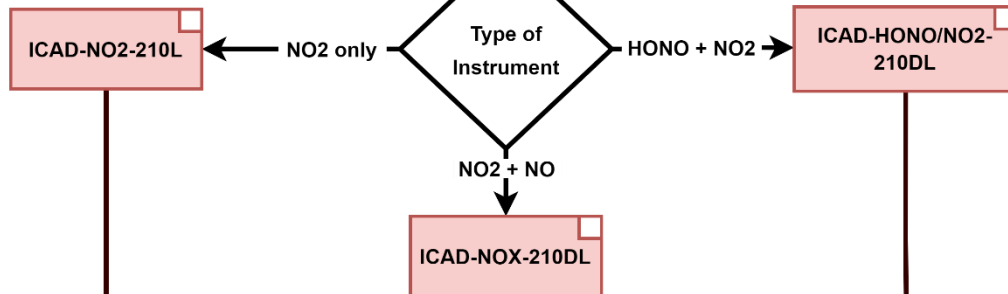

INSTRUMENT CONFIGURATION

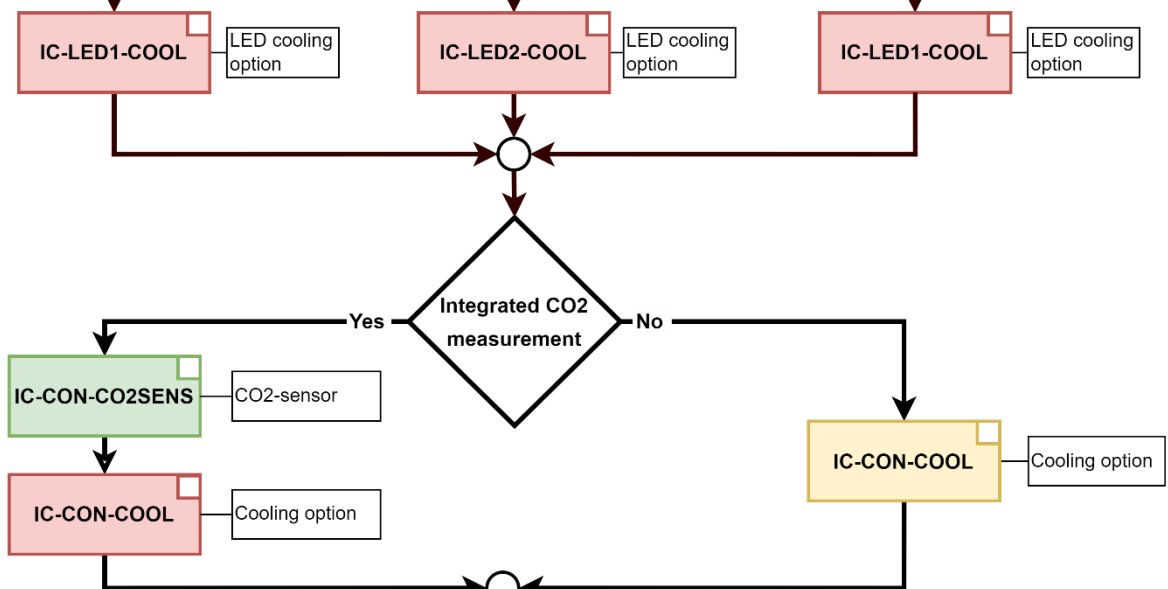

EXTENSIONS AND ACCESSORIES

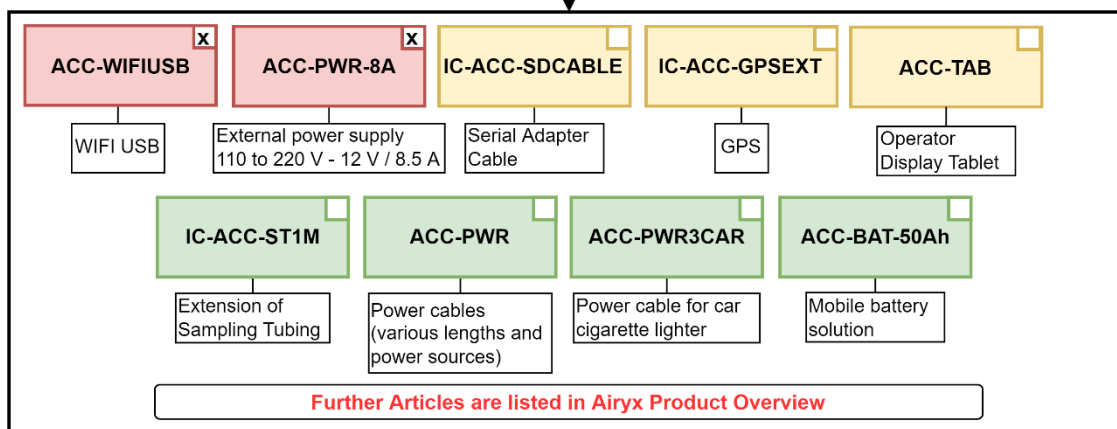



MAINTENANCE EQUIPMENT AND SPARE PARTS

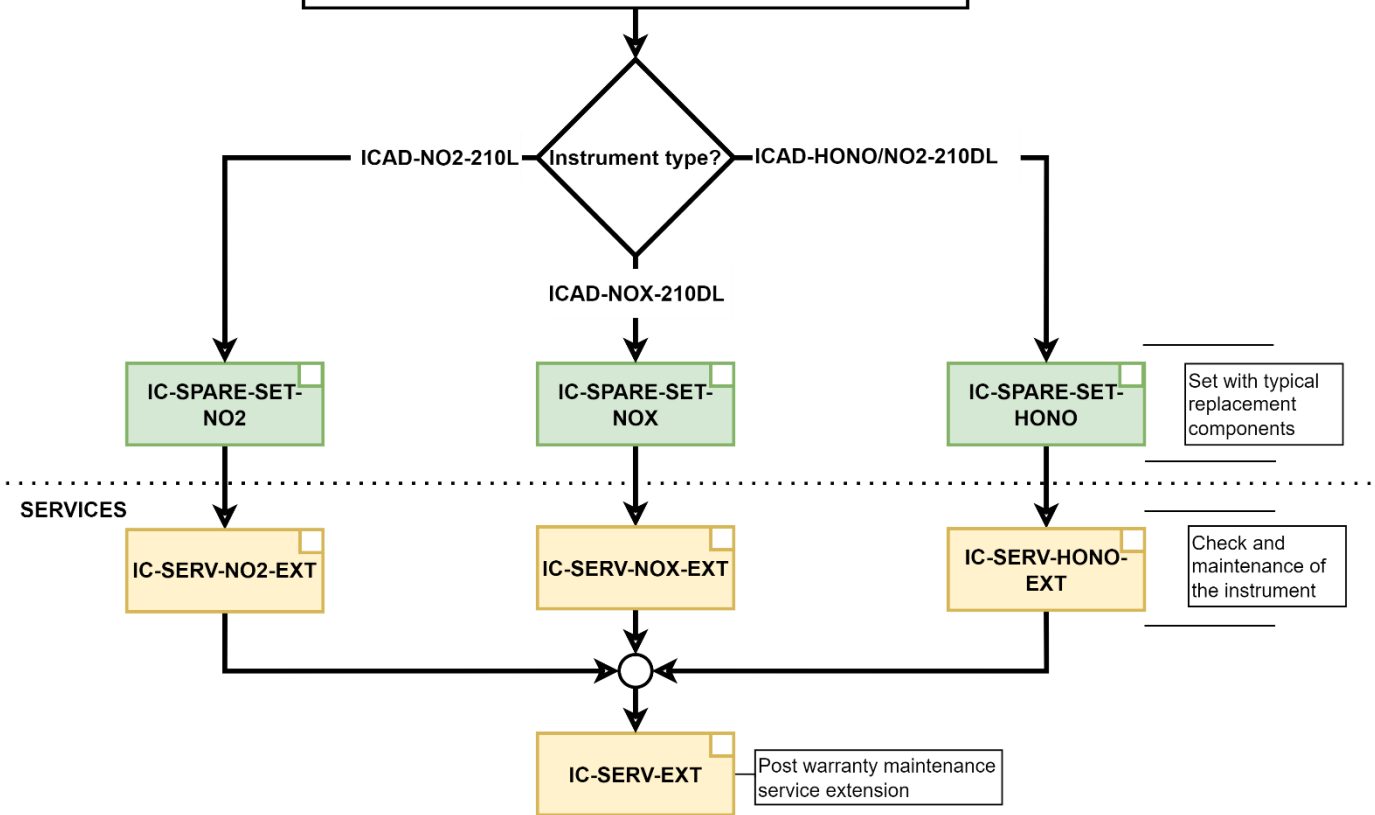
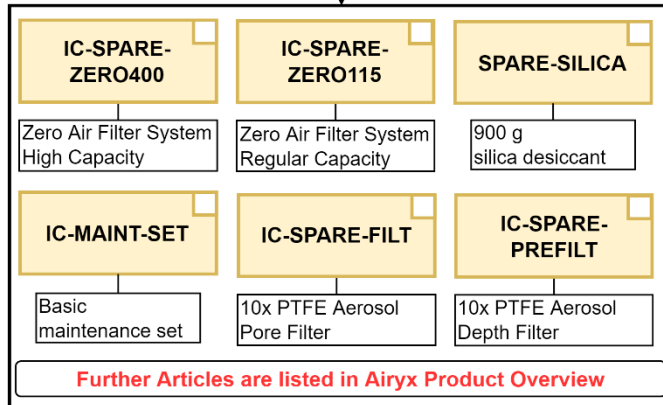

SERVICES

# Simultaneous NOx and CO2 measurements *with internal CO2-Sensor*

## INSTRUMENT TYPE

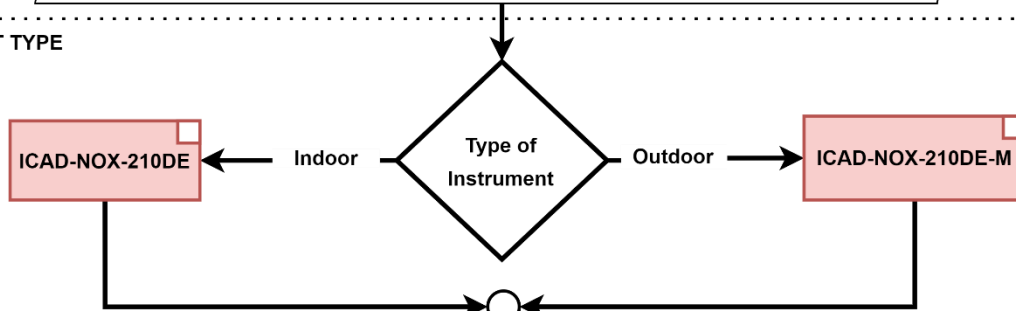

## EXTENSIONS AND ACCESSORIES

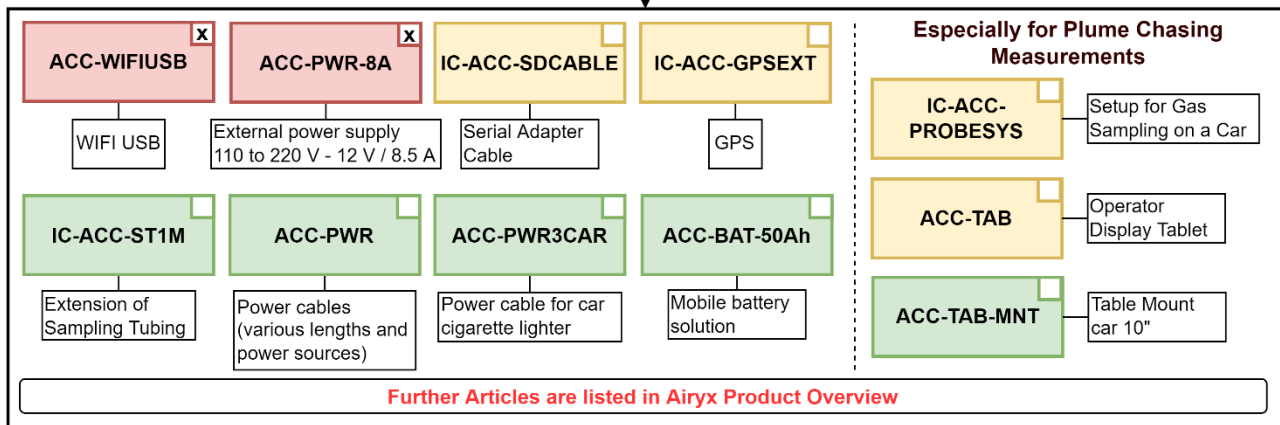

## MAINTENANCE EQUIPMENT AND SPARE PARTS

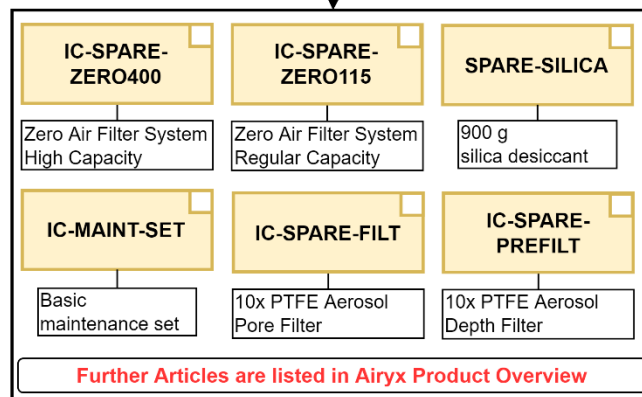

## SERVICES

