

WindSonic1

Two-Dimensional
Sonic Anemometer
with RS-232 Output



Table of contents

1. Introduction	1
2. Precautions	1
3. Initial inspection	2
4. QuickStart	2
5. Overview	5
6. Specifications	5
6.1 Wind direction	6
6.2 Wind speed	6
7. Installation	6
7.1 Data logger-to-WindSonic1 wiring	6
7.2 SDM-SIO1A/SDM-SIO4A wiring	7
7.3 Data logger programming	8
7.3.1 CRBasic programming	9
7.4 Siting	9
7.5 Mount the sensor	9
8. Operation	10
8.1 Sensor configuration	11
8.2 Campbell Scientific factory default settings	11
8.3 Sensor output	13
8.4 Long cables	14
9. Maintenance and troubleshooting	14
9.1 Troubleshooting	14
9.2 Maintenance	15
10. Siting references	15
Appendix A. Importing Short Cut code into CRBasic Editor	16
Appendix B. Determining True North and sensor orientation	17
B.1 Online magnetic declination calculator	19

Appendix C. Updating an older program for the new WindSonic1 settings	21
Appendix D. Using the CPI/RS-232 port	23

1. Introduction

The WindSonic1 is a two-dimensional ultrasonic anemometer for measuring wind speed and wind direction. It provides an alternative to traditional mechanical cup and vane or propeller and vane anemometers. Unlike mechanical anemometers, the WindSonic1 has no moving parts that need to be periodically replaced—minimizing routine maintenance costs.

The WindSonic1 outputs an RS-232 signal.

NOTE:

This manual provides information only for CRBasic data loggers. For retired Edlog data logger support, see an older manual at www.campbellsci.com/old-manuals .



2. Precautions

- READ AND UNDERSTAND the [Safety](#) section at the back of this manual.
- The WindSonic1 is not recommended for conditions where rime, ice, or horizontal snow will occur. It is not heated.
- The WindSonic1 is a precision instrument. Please handle it with care.
- If the WindSonic1 is to be installed at heights over 2 m (6 ft), be familiar with tower safety and follow safe tower climbing procedures.
- DANGER—Use extreme care when working near overhead electrical wires. Check for overhead wires before mounting the WindSonic1 or before raising a tower.
- WindSonic1 default settings were changed in February 2013. WindSonic1 anemometers with newer settings will not work with older programs and *Short Cut* 3.0 or older. See [Campbell Scientific factory default settings](#) (p. 11) and [Updating an older program for the new WindSonic1 settings](#) (p. 21) for more information.
- The black outer jacket of the cable is Santoprene® rubber. This compound was chosen for its resistance to temperature extremes, moisture, and UV degradation. However, this jacket will support combustion in air. It is rated as slow burning when tested according to U.L. 94 H.B. and will pass FMVSS302. Local fire codes may preclude its use inside buildings.

3. Initial inspection

- Upon receipt of the WindSonic1, inspect the packaging and contents for damage. File damage claims with the shipping company. Immediately check package contents against the shipping documentation. Contact Campbell Scientific about any discrepancies.
- The model number and cable length are printed on a label at the connection end of the cable. Check this information against the shipping documents to ensure the expected product and cable length are received.

4. QuickStart

A video that describes data logger programming using *Short Cut* is available at: www.campbellsci.com/videos/cr1000x-data-logger-getting-started-program-part-3 . *Short Cut* is an easy way to program your data logger to measure the sensor and assign data logger wiring terminals. *Short Cut* is available as a download on www.campbellsci.com . It is included in installations of *LoggerNet*, *RTDAQ*, and *PC400*.

The following procedure also shows using *Short Cut* to program the WindSonic1.

1. Open *Short Cut* and click **Create New Program**.
2. Double-click the data logger model.

- In the **Available Sensors and Devices** box, type **WindSonic1** or locate the sensor in the **Sensors > Meteorological > Wind Speed & Direction** folder. Double-click either **WindSonic1 (RS-232 9.6K baud)** or **WindSonic1 (RS-232 38.4K baud)**; 9.6K baud is the factory-default setting. The wind speed defaults to meters per second. This can be changed by clicking the **Wind Speed** box and selecting one of the other options.

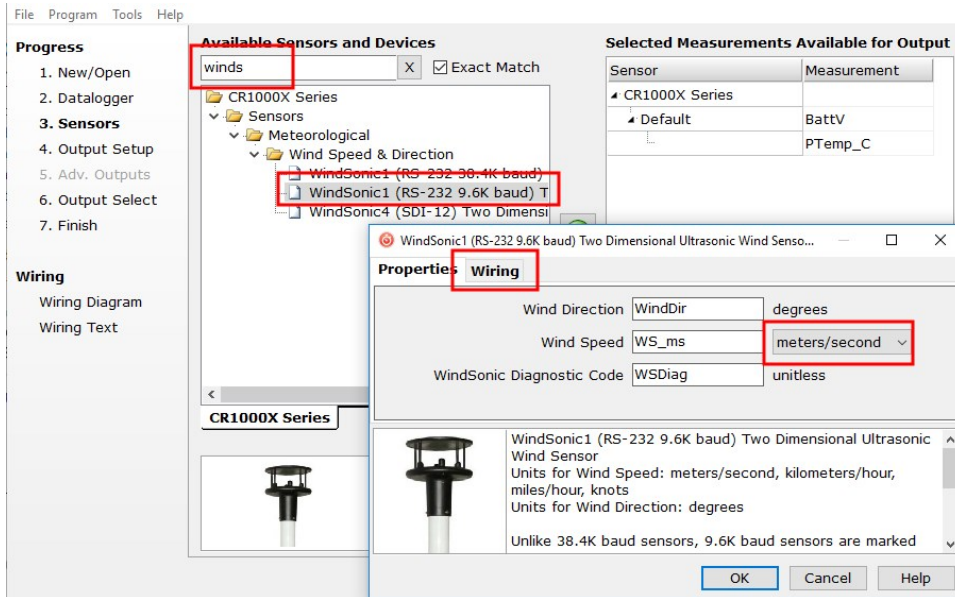

- Click on the **Wiring** tab to see how the sensor is to be wired to the data logger. Click **OK** after wiring the sensor.

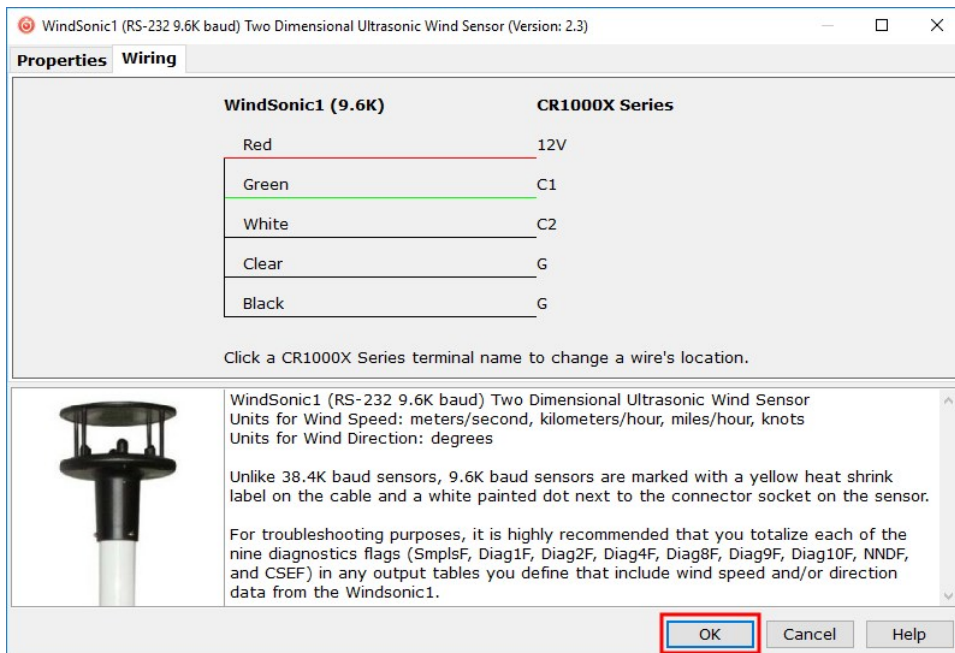

- Repeat steps 3 and 4 for other sensors.

- In **Output Setup**, type the scan rate, meaningful table names, and **Data Output Storage Interval**. Click **Next**.

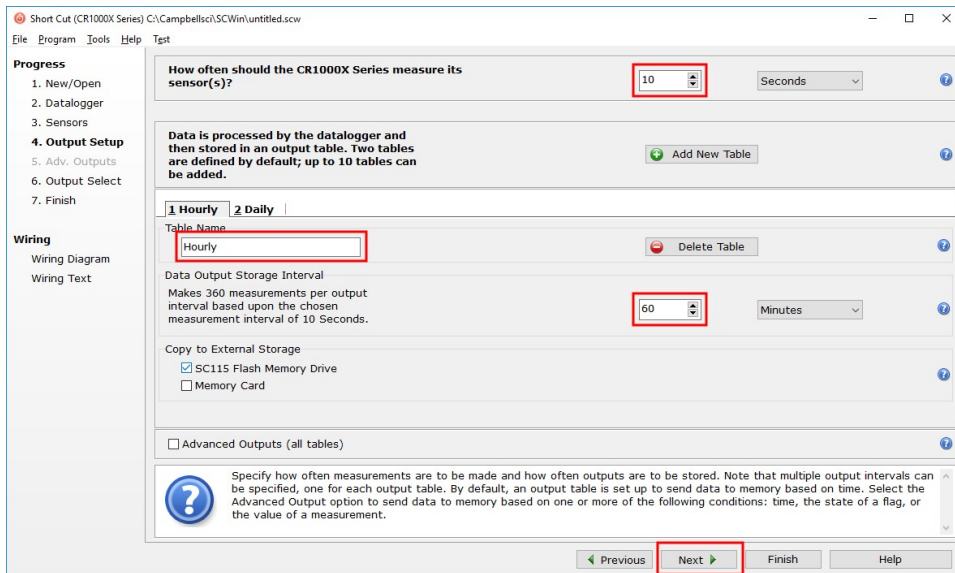

- Select the measurement and its associated output option.

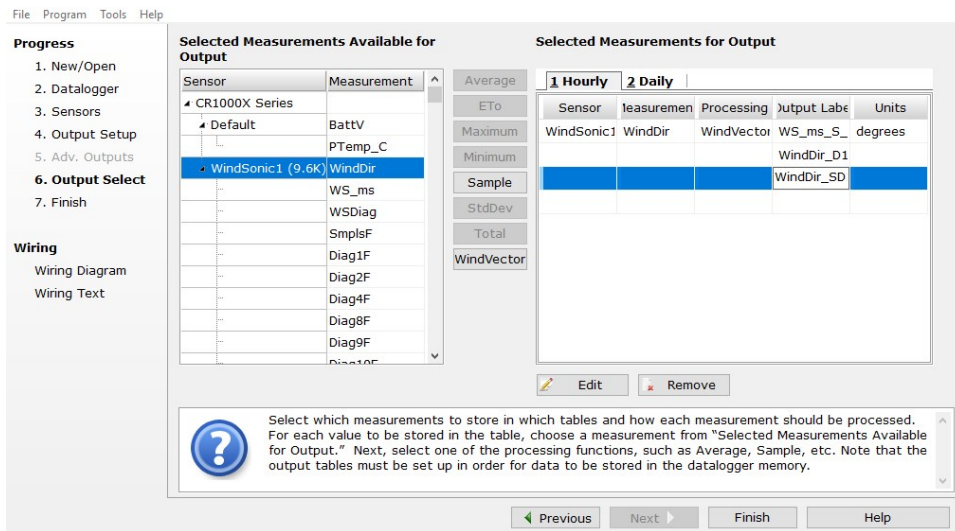

- Click **Finish** and save the program. Send the program to the data logger if the data logger is connected to the computer.
- If the sensor is connected to the data logger, check the output of the sensor in the data display in **LoggerNet**, **RTDAQ**, or **PC400** to make sure it is making reasonable measurements.

5. Overview

The WindSonic1 is manufactured by Gill Instruments, Ltd. It is an ultrasonic anemometer for measuring wind direction and wind speed. Two pairs of orthogonally oriented transducers sense horizontal wind. The transducers bounce the ultrasonic signal from a hood, minimizing the effects of transducer shadowing and flow distortion.

The WindSonic1 outputs data using the RS-232 interface. It connects to two **C** or **U** terminals or to the **CPI/RS-232** port by using an RJ45 terminal block adapter. The WindSonic1 is also compatible with the SDM-SIO1A and SDM-SIO4A devices, which increase the number of serial sensors one data logger can measure. The WindSonic1 is not compatible with the CR200(X)-series or CR5000 data loggers. A similar sensor, the Wind Sonic4, is compatible with the CR200(X)-series and CR5000; refer to www.campbellsci.com/windsonic4 for more information.

The WindSonic1 includes a user-specified cable to interface to a Campbell Scientific data logger. A serial cable (WINDSONICRCBL-L) is available for interfacing a WindSonic1 to a computer running the manufacturer's computer support software. The cable and software are used during troubleshooting or to change settings for a specific application. A copy of this computer support software is available at www.gill.co.uk/main/software.html. WindView is used for WindSonic1 anemometers with serial numbers of 0810001 or greater, and WindCom is used for WindSonic1 anemometers with serial numbers that are less than 0810001.

Features:

- Low maintenance—no moving parts significantly reduces maintenance cost and time
- Minimum detectable wind speed of 0.01 meters per second
- Compatible with Campbell Scientific CRBasic data loggers: CR6, CR3000, CR1000X, CR800 series, CR300 series, and CR1000
- Compatible with the SDM-SIO1A and SDM-SIO4A serial modules, which allows one data logger to measure more WindSonic1 anemometers

6. Specifications

Output signal:	RS-232
Measurement frequency:	40 Hz block averaged to a programmable output frequency, factory set to 1 Hz

Current drain:	~15 mA continuous
Operating temperature:	-35 to 70 °C
Storage temperature:	-40 to 80 °C
Dimensions:	142 x 160 mm (5.6 x 6.3 in)
Weight:	500 g (1.1 lb)
Operating humidity:	<5% to 100% RH

6.1 Wind direction

Operating range:	0 to 359° (no dead band)
Accuracy:	±3°
Output resolution:	1°

6.2 Wind speed

Operating range:	0 to 60 m/s
Accuracy:	±2% @ 12 m/s
Output resolution:	0.01 m/s

7. Installation

If you are programming your data logger with *Short Cut*, skip [Data logger-to-WindSonic1 wiring](#) (p. 6) and [Data logger programming](#) (p. 8). *Short Cut* does this work for you. See [QuickStart](#) (p. 2) for a *Short Cut* tutorial.

7.1 Data logger-to-WindSonic1 wiring

The WindSonic1 supports serial communications with dedicated UART hardware on the data logger control or universal terminals. Two control or universal terminals are configured as a single communications (COMn) port.

NOTE:

The WindSonic1 can also connect to the **CPI/RS-232** port on a CR6 or CR1000X by using an RJ45 terminal block adapter. Information about using this adapter is provided in [Using the CPI/RS-232 port](#) (p. 23).

The WindSonic1 serial interface uses four wires as shown in [Table 7-1](#) (p. 7).

Description	Color	Data logger
WindSonic RxD	Green	C, U configured for RS-232 Tx ¹
WindSonic TxD	White	C, U configured for RS-232 Rx ¹
Power	Red	12V
Serial/power reference	Black	G
Shield	Clear	G

¹**U** and **C** terminals are automatically configured by the measurement instruction for Campbell Scientific CR6 data logger.

NOTE:

The maximum cable length depends on the baud rate, the nominal resistance of the wire, the capacitance between conductors, and the capacitance between the conductors and shield. The Electronic Industries Association RS-232D standard suggests limiting the RS-232 cable lengths to 15.2 m (50 ft) or less at 9600 bps.

7.2 SDM-SIO1A/SDM-SIO4A wiring

The SDM-SIO1A and SDM-SIO4A allow one data logger to measure more serial sensors. The SDM-SIO1A/SDM-SIO4A converts RS-232 signals into synchronous device for measurements (SDM) signals. SDM is a Campbell Scientific digital communications protocol used between Campbell Scientific data loggers and SDM peripherals. At a 1 Hz measurement rate, a maximum of four WindSonic1 sensors can be measured by a data logger. [Table 7-2](#) (p. 8) describes the connections between the devices. The SDM-SIO1A and SDM-SIO4A are not compatible with the CR300-series data loggers.

Table 7-2: Wire color, function, and connections to SDM-SIO1A/SDM-SIO4A and data logger

Description	WindSonic1 wire color	SDM-SIO1A/SDM-SIO4A terminal	Data logger terminal
WindSonic RxD	Green	TX-Z	
WindSonic TxD	White	RX-A	
Power	Red	+12V	12V
Serial/ power reference	Black	G	
Shield	Clear	G	
SDM data enable line		C1	C (control terminal) or U terminal configured for SDM enable ¹
SDM clock line		C2	C (control terminal) or U terminal configured for SDM clock ¹
SDM data line		C3	C (control terminal) or U terminal configured for SDM data ¹

¹U and C terminals are automatically configured by the measurement instruction for Campbell Scientific CR6 data logger.

7.3 Data logger programming

Short Cut is the best source for up-to-date programming code for Campbell Scientific data loggers. If your data acquisition requirements are simple, you can probably create and maintain a data logger program exclusively with *Short Cut*. If your data acquisition needs are more complex, the files that *Short Cut* creates are a great source for programming code to start a new program or add to an existing custom program.

NOTE:

Short Cut cannot edit programs after they are imported and edited in *CRBasic Editor*.

A *Short Cut* tutorial is available in [QuickStart](#) (p. 2). If you wish to import *Short Cut* code into *CRBasic Editor* to create or add to a customized program, follow the procedure in [Importing Short Cut code into CRBasic Editor](#) (p. 16). Programming basics for *CRBasic* data loggers are provided in the following section. Downloadable example programs are available at www.campbellsci.com/downloads/windsonic1-program-examples .

7.3.1 CRBasic programming

The WindSonic1 updates the RS-232 output to a user-set frequency. CRBasic data loggers use `SerialInRecord()` to retrieve the latest record sent by the WindSonic1 at the scan interval. This ensures that the most current wind data is available for use by the program.

The data logger and WindSonic1 each use their own internal clocks. These clocks are not perfectly synchronized with each other and will drift in and out of phase. This phase drift could cause missed samples because no new data was transmitted to the data logger in time for the next scan. The data logger program can record the number of missed samples, which will occur if the WindSonic1 is disconnected from the serial port, the WindSonic1 has no power, or the data logger and WindSonic1 clocks have drifted out of phase by one cycle. The example programs available at www.campbellsci.com/downloads/windsonic1-program-examples record the number of missed records.

NOTE:

For the CR800-series, CR3000, and CR1000 data loggers, early versions of the data logger operating systems (OS) did not support serial communication using control terminals or the `SerialInRecord()` instruction. It may be necessary to update the data logger OS. The most current data logger operating systems are available on the Campbell Scientific website at: www.campbellsci.com/downloads.

7.4 Siting

Locate the WindSonic1 away from obstructions such as trees and buildings. The distance between wind sensors and the nearest obstruction should be ten times the height of the obstruction. If it is necessary to mount the WindSonic1 on the roof of a building, the height of the sensor, above the roofline, should be at least 1.5 times the height of the building. See [Siting references](#) (p. 15) for a list of references that discuss siting wind direction and speed sensors.

7.5 Mount the sensor

Mount the WindSonic1 using the WindSonic Mounting Pipe Kit, which consists of an aluminum mounting tube, three pan truss screws, CM220 Right Angle Mounting bracket, two U-bolts, and four nuts.

1. Thread the connector end of the cable through the mounting tube; start at the end without the three threaded holes.

2. Attach the female mating connector on the cable to the male mating connector located on the bottom of the WindSonic1.
3. Secure the WindSonic1 to the mounting tube using the three pan-head screws.
4. Attach the mounting tube to a crossarm using the the CM220 Right Angle Mounting bracket, U-bolts, and nuts (see [FIGURE 7-1](#) (p. 10)).
5. Mount the crossarm to the tripod or tower.
6. Orient the WindSonic1 so that the colored North marker arrows point to True North (see [FIGURE 7-1](#) (p. 10)). See [Determining True North and sensor orientation](#) (p. 17) for more information.



FIGURE 7-1. WindSonic1 mounted on a crossarm

7. Route the sensor cable along the underside of the crossarm to the tripod or tower, and to the instrument enclosure.
8. Secure the cable to the crossarm and tripod or tower using cable ties.

8. Operation

This section discusses the following:

8.1 Sensor configuration	11
8.2 Campbell Scientific factory default settings	11

8.3 Sensor output	13
8.4 Long cables	14

8.1 Sensor configuration

To mimic a mechanical anemometer, the WindSonic1 output frequency must match the data logger scan frequency. The factory setting for the WindSonic1 is 1 Hz, which is 1 output per second.

The data output frequency of the WindSonic1 can be set to five discrete values (see [Table 8-1](#) (p. 11)) using Gill's computer support software and the RS-232 WindSonic to computer cable.

Output frequency (Hz)	Seconds per output (s)
4	0.25
2	0.5
1	1
0.5	2
0.25	4

8.2 Campbell Scientific factory default settings

[Table 8-3](#) (p. 13) provides the factory-default settings. The default settings for the WindSonic1 were changed in February 2013 to improve operation in cold temperatures. Sensors with the new settings can be identified by a small white painted dot next to the connector on the underside of the sensor ([FIGURE 8-1](#) (p. 13)). New sensor cables include both a yellow and white heat shrink label; older sensor cables had two white heat shrink labels. Because cables are interchangeable between new and old sensors, the best check is to look for the painted dot.

Setting description	Setting	Comments
Continuous polar wind	M2	
Wind speed in m/s	U1	
Field formatted, comma separated values	O1	Changed in February 2013

Table 8-2: WindSonic1 factory-default settings

Setting description	Setting	Comments
Terminate records with a carriage return and line feed	L1	
1 Hz output frequency	P1	
Baud rate – 9600 baud	B3	Changed in February 2013
Power-up message	H1	Changed in February 2013
Address set to "Q"	NQ	
Data bits and parity — 8 bits, no parity	F1	
RS-232 interface	E3	
Analog output 0 to 5 VDC	T1	Does not apply
Analog range 0 to 30 m/s	S4	Does not apply
Analog wrap around 0 to 360 degrees	C2	Does not apply
Minimum direction velocity	K50	

CAUTION:

WindSonic1 anemometers with the newer default settings will not work with older programs or *Short Cut* 3.0 or older. Refer to [Updating an older program for the new WindSonic1 settings](#) (p. 21) for more information.



FIGURE 8-1. White dot indicating that the WindSonic1 has the newer settings

8.3 Sensor output

The WindSonic1 outputs out a comma delineated ASCII string. [Table 8-3](#) (p. 13) shows an example string and the element meaning.

Table 8-3: WindSonic1 output string	
Example string: <STX>Q, 229, 002.74, M, 00, <ETX> 16<CR><LF>	
Element in example string	Meaning
<STX>	Start of string character (ASCII value 2)
Q	WindSonic node address (Q is the default)
229	Wind direction, degrees
002.74	Wind speed, m/s
M	Units of wind speed (m/s is the default)
00	Sensor diagnostic code (see Table 9-1 (p. 14))
<ETX>	End of string character (ASCII value 3)
16	Checksum of bytes between <STX> and <ETX>
CR	Carriage return (ASCII value 13)
LF	Line Feed (ASCII value 10)

8.4 Long cables

Communications between the WindSonic1 and the data logger will most likely fail if its cable is extended beyond 15 m (50 ft). Digital data transfer eliminates offset errors due to cable lengths. However, digital communications can break down when cables are too long, resulting in either no response from the sensor or corrupted readings.

9. Maintenance and troubleshooting

NOTE:

All factory repairs and recalibrations require a returned material authorization (RMA) and completion of the "Statement of Product Cleanliness and Decontamination" form. Refer to the [Assistance](#) page at the end of this manual for more information.

9.1 Troubleshooting

The WindSonic1 outputs a status code ([Table 9-1](#) (p. 14)) along with each wind direction and speed measurement. The data logger program can filter out data when the status code is not 00. If the WindSonic1 is not powered, not connected, is using the wrong COM port, or has missed a sample, the wind direction and speed measurement will be NaN. The program can filter out these values and report the number of good samples that were used in computing the online statistics. If the total number of good samples is less than 98% of the expected samples, send the WindSonic1 to the factory for repair (see [Assistance](#)).

Code	Status	Comment
00	Okay	All okay
01	Axis 1 failed	Insufficient samples, possible path obstruction
02	Axis 2 failed	Insufficient samples, possible path obstruction
04	Both axes failed	Insufficient samples, possible path obstruction
08	NVM error	Nonvolatile Memory checksum failed
09	ROM error	Read Only Memory checksum failed

9.2 Maintenance

There are no user-serviceable parts on the WindSonic1. Keep the transducer paths clear of any obstructions.

CAUTION:

When clearing the transducer paths, do not remove or damage the rubber caps on the transducers.

Use a cloth and mild detergent to gently clean the transducers.

CAUTION:

Do not use solvents and avoid scratching or damaging the rubber caps.

If the WindSonic1 is damaged, fails to output data, or sends a nonzero status number ([Table 9-1](#) (p. 14)), return it to Campbell Scientific for repair (see [Assistance](#)).

10. Siting references

The following references give detailed information on siting wind direction and wind speed sensors.

EPA, 1987: *On-Site Meteorological Program Guidance for Regulatory Modeling Applications*, EPA-450/4-87-013, Office of Air Quality Planning and Standards, Research Triangle Park, NC, 27711.

EPA, 1989: *Quality Assurance Handbook for Air Pollution Measurements System*, Office of Research and Development, Research Triangle Park, NC, 27711.

The State Climatologist, 1985: *Publication of the American Association of State Climatologists: Height and Exposure Standards, for Sensors on Automated Weather Stations*, vol. 9, No. 4.

WMO, 1983: *Guide to Meteorological Instruments and Methods of Observation*, World Meteorological Organization, No. 8, 5th edition, Geneva, Switzerland.

Appendix A. Importing *Short Cut* code into *CRBasic Editor*

Short Cut creates a .DEF file that contains wiring information and a program file that can be imported into the *CRBasic Editor*. By default, these files reside in the C:\campbellsci\SCWin folder.

Import *Short Cut* program file and wiring information into *CRBasic Editor*:

1. Create the *Short Cut* program. After saving the *Short Cut* program, click the **Advanced** tab then the **CRBasic Editor** button. A program file with a generic name will open in CRBasic. Provide a meaningful name and save the CRBasic program. This program can now be edited for additional refinement.

NOTE:

Once the file is edited with *CRBasic Editor*, *Short Cut* can no longer be used to edit the program it created.

2. To add the *Short Cut* wiring information into the new CRBasic program, open the .DEF file located in the C:\campbellsci\SCWin folder, and copy the wiring information, which is at the beginning of the .DEF file.
3. Go into the CRBasic program and paste the wiring information into it.
4. In the CRBasic program, highlight the wiring information, right-click, and select **Comment Block**. This adds an apostrophe (') to the beginning of each of the highlighted lines, which instructs the data logger compiler to ignore those lines when compiling. The **Comment Block** feature is demonstrated at about 5:10 in the [CRBasic | Features](#) video .

Appendix B. Determining True North and sensor orientation

The orientation of the WindSonic1 north arrow markers is found by reading a magnetic compass and applying the site-specific correction for magnetic declination; where the magnetic declination is the number of degrees between true north and magnetic north. Obtain the magnetic declination for a specific site from a USGS map, local airport, or through a NOAA web calculator ([Online magnetic declination calculator](#) (p. 19)). A general map showing magnetic declination for the Conterminous United States is shown in [FIGURE B-1](#) (p. 17).

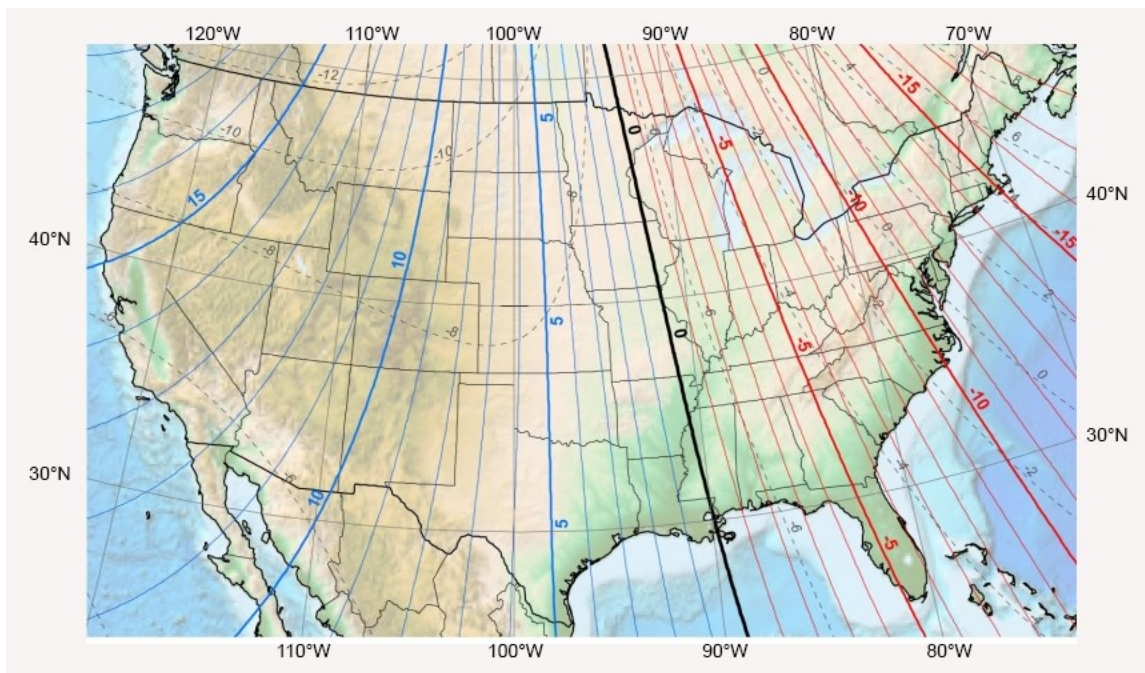

FIGURE B-1. Magnetic declination for the conterminous United States (2015)

Declination angles east of True North are considered negative, and are subtracted from 360 degrees to get True North as shown [FIGURE B-2](#) (p. 18) (0° and 360° are the same point on a compass). Declination angles west of True North are considered positive, and are added to 0 degrees to get True North as shown in [FIGURE B-3](#) (p. 18).

For example, the declination for Longmont, CO (10 June 2006) is 9.67° , thus True North is $360^\circ - 9.67^\circ$, or 350.33° as read on a compass. Likewise, the declination for McHenry, IL (10 June 2006) is -2.68° , and True North is $0^\circ - (-2.68^\circ)$, or 2.68° as read on a compass.

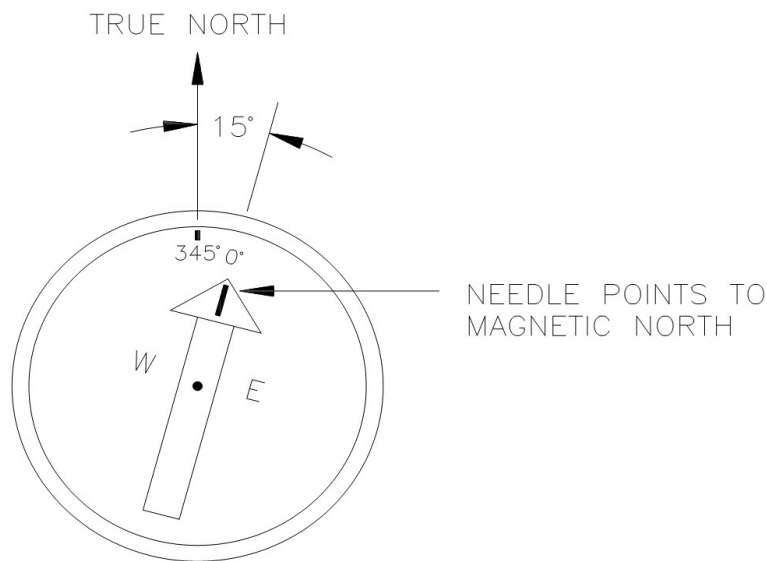

FIGURE B-2. A declination angle east of True North (positive) is subtracted from 360 (0) degrees to find True North

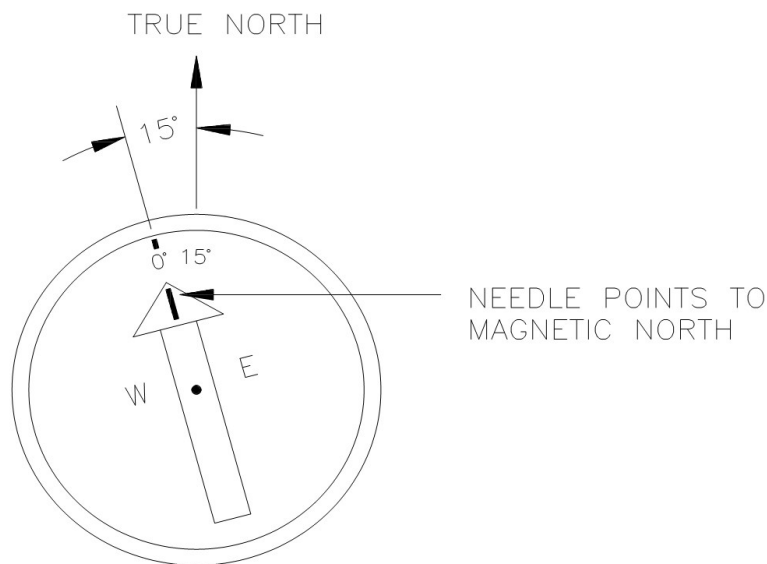

FIGURE B-3. A declination angle west of True North (negative) is subtracted from 0 (360) degrees to find True North

B.1 Online magnetic declination calculator

The magnetic declination web calculator published by NOAA's Geophysical Data Center is available at www.ngdc.noaa.gov/geomag-web. This web page calculates declination based on the latitude and longitude. You can look up your site's latitude and longitude by entering the **Zip Code** or the **Country** and **City**, and then clicking the **Get & Add Lat/Lon** button (FIGURE B-4 (p. 19)). Click the **Calculate** button to get the magnetic declination.

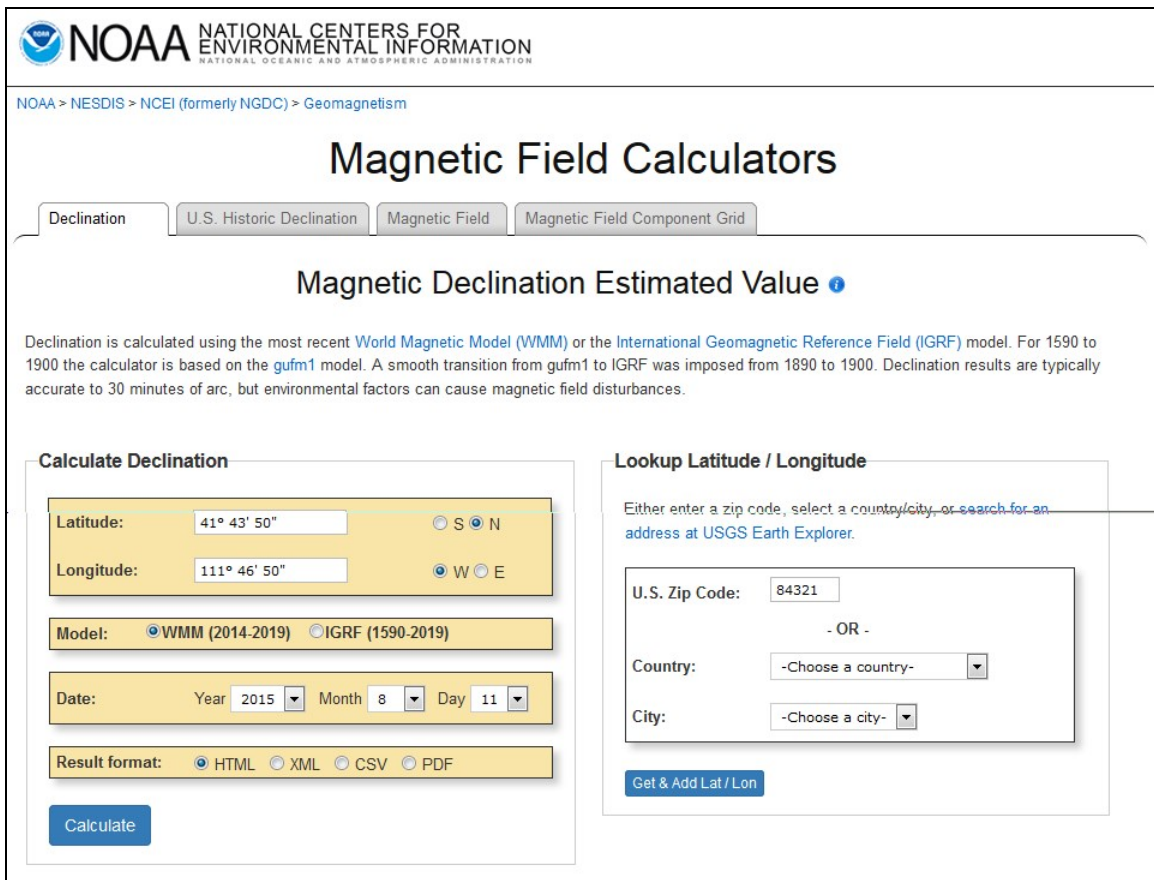

FIGURE B-4. NOAA web calculator

FIGURE B-5 (p. 20) shows that the calculated declination for Logan, UT is 11.78 degrees (11 August 2015). The declination for Utah is positive (east of north), so True North for this site is $360 - 11.78$, or 348.22 degrees. The annual change is 6 minutes west per year.

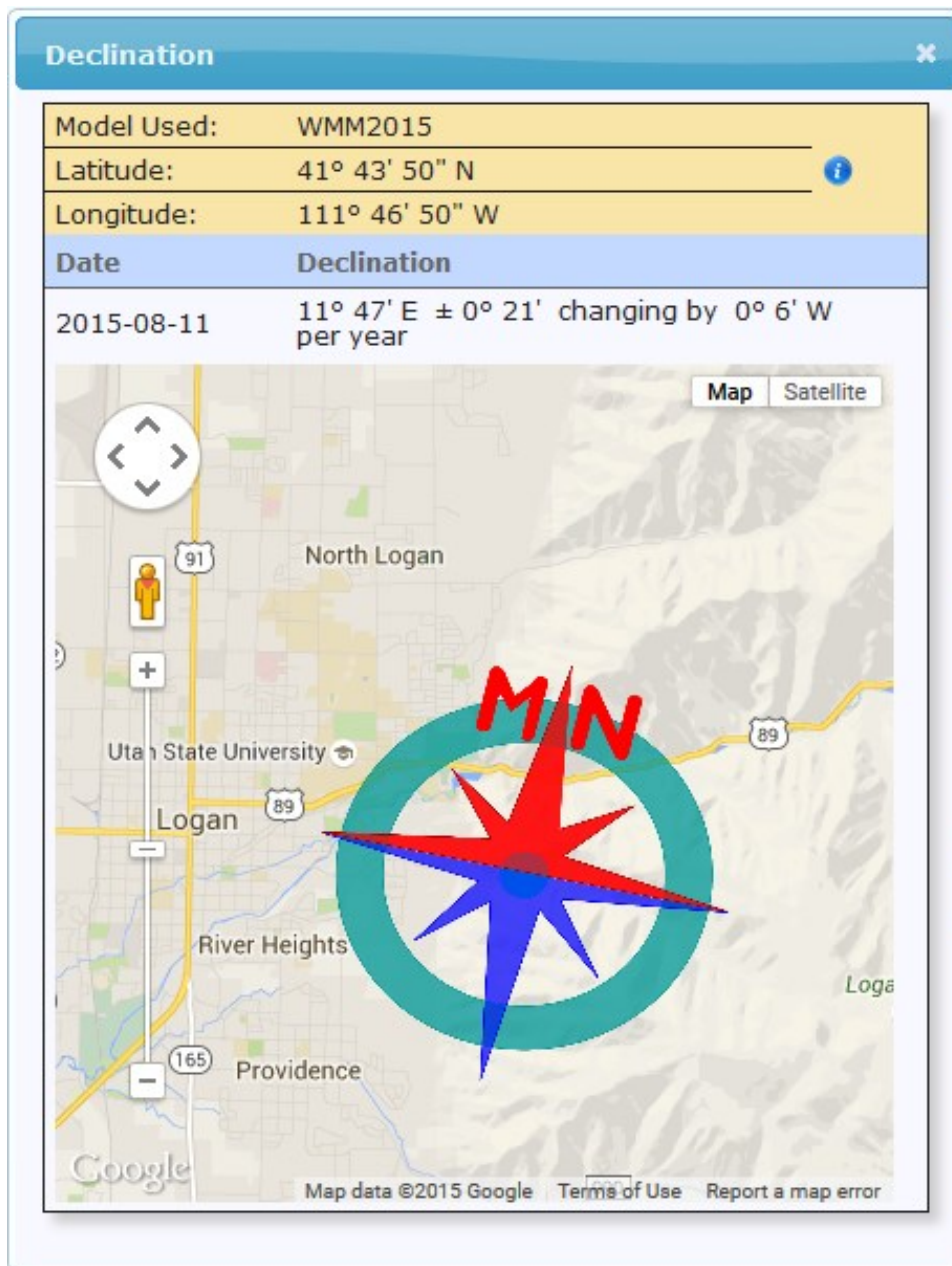

FIGURE B-5. NOAA calculated declination using HTML result format

Appendix C. Updating an older program for the new WindSonic1 settings

In February 2013, the settings of the WindSonic1 were changed to improve operation in cold temperatures. The communication baud rate changed from 38,400 to 9600 bps, and the data output structure changed to the manufacturer's default. [Campbell Scientific factory default settings](#) (p. 11) lists the newer default settings.

Sensors with the new settings can be identified by a small white painted dot next to the connector on the underside of the sensor ([FIGURE 8-1](#) (p. 13)). New sensor cables include both a yellow and white heat shrink label; older sensor cables had two white heat shrink labels. Because cables are interchangeable between new and old sensors, the best check is to look for the painted dot.

CAUTION:

Sensors with newer settings will NOT work with older programs written for sensors set to 38,400 baud or *Short Cut* version 3.0 or older.

Older WindSonic1 programs can be changed in the *CRBasic Editor*. [Table C-1](#) (p. 22) shows the instructions that need to be changed to update the program for the current settings. For additional support, contact Campbell Scientific at (435) 227-9000 or email support@campbellsci.com .

Table C-1: Instructions updated for current factory-default settings	
Old instructions	New instructions
<pre>Public windsonic(4) Alias windsonic(1) = wind_direction Alias windsonic(2) = wind_speed Alias windsonic(3) = diag Alias windsonic(4) = nmbr_bytes_rtrnd</pre>	<pre>Dim windsonic(4) As String Public wind_direction Public wind_speed Public diag Public nmbr_bytes_rtrnd</pre>
<pre>SerialOpen (Com1,38400,3,0,49)</pre>	<pre>SerialOpen (Com1,9600,3,0,105)</pre>
<pre>wind_direction = Mid (in_bytes_str,3,3) wind_speed = Mid (in_bytes_str,7,6) diag = Mid (in_bytes_str,16,2)</pre>	<pre>SplitStr (windsonic(),in_bytes_str,",",4,4) wind_direction = windsonic(1) wind_speed = windsonic(2) diag = windsonic(4)</pre>
<pre>checksum_flg = ((HexToDec (Mid (in_bytes_str,20,2))) EQV _ (CheckSum(in_bytes_str,9,18)))</pre>	<pre>checksum_flg = ((HexToDec (Right (in_bytes_str,2))) EQV _ (CheckSum (in_bytes_str,9,Len (in_bytes_str)-3)))</pre>

Appendix D. Using the CPI/RS-232 port

An RJ45 terminal block adapter allows the WindSonic1 to be connected to the **CPI/RS-232** port on a CR6 or CR1000X. The **CPI/RS-232** port is typically only used if control or universal terminals are not available. [Table D-1](#) (p. 23) provides information about connecting the WindSonic1 to the adapter and CR6 or CR1000X.

Table D-1: CPI/RS-232 connections		
WindSonic1 wire color	RJ45 terminal block connection	Data logger connection
Green (RXD)	PIN 1 TXD	
White (TXD)	PIN 2 RXD	
Red (12 to 24 VDC)		12V
Black (power ground)		G
Clear (shield – ground)		G
	RJ45 connector	CPI/RS-232

In the data logger program, use **ComRS232** for the ComPort parameter of [SerialInRecord\(\)](#). For example:

```
SerialInRecord (ComRS232, in_bytes_str, &h02, 0, &h0d0a, nmb_r_bytes_rtrnd, 01)
```

Limited warranty

Products manufactured by Campbell Scientific are warranted by Campbell Scientific to be free from defects in materials and workmanship under normal use and service for twelve months from the date of shipment unless otherwise specified on the corresponding product webpage. See Product Details on the Ordering Information pages at www.campbellsci.com[↗]. Other manufacturer's products, that are resold by Campbell Scientific, are warranted only to the limits extended by the original manufacturer.

Refer to www.campbellsci.com/terms#warranty[↗] for more information.

CAMPBELL SCIENTIFIC EXPRESSLY DISCLAIMS AND EXCLUDES ANY IMPLIED WARRANTIES OF MERCHANTABILITY OR FITNESS FOR A PARTICULAR PURPOSE. Campbell Scientific hereby disclaims, to the fullest extent allowed by applicable law, any and all warranties and conditions with respect to the Products, whether express, implied or statutory, other than those expressly provided herein.

Assistance

Products may not be returned without prior authorization.

Products shipped to Campbell Scientific require a Returned Materials Authorization (RMA) or Repair Reference number and must be clean and uncontaminated by harmful substances, such as hazardous materials, chemicals, insects, and pests. Please complete the required forms prior to shipping equipment.

Campbell Scientific regional offices handle repairs for customers within their territories. Please see the back page for the Global Sales and Support Network or visit www.campbellsci.com/contact  to determine which Campbell Scientific office serves your country.

To obtain a Returned Materials Authorization or Repair Reference number, contact your CAMPBELL SCIENTIFIC regional office. Please write the issued number clearly on the outside of the shipping container and ship as directed.

For all returns, the customer must provide a "Statement of Product Cleanliness and Decontamination" or "Declaration of Hazardous Material and Decontamination" form and comply with the requirements specified in it. The form is available from your CAMPBELL SCIENTIFIC regional office. Campbell Scientific is unable to process any returns until we receive this statement. If the statement is not received within three days of product receipt or is incomplete, the product will be returned to the customer at the customer's expense. Campbell Scientific reserves the right to refuse service on products that were exposed to contaminants that may cause health or safety concerns for our employees.

Safety

DANGER — MANY HAZARDS ARE ASSOCIATED WITH INSTALLING, USING, MAINTAINING, AND WORKING ON OR AROUND **TRIPODS, TOWERS, AND ANY ATTACHMENTS TO TRIPODS AND TOWERS SUCH AS SENSORS, CROSSARMS, ENCLOSURES, ANTENNAS, ETC.** FAILURE TO PROPERLY AND COMPLETELY ASSEMBLE, INSTALL, OPERATE, USE, AND MAINTAIN TRIPODS, TOWERS, AND ATTACHMENTS, AND FAILURE TO HEED WARNINGS, INCREASES THE RISK OF DEATH, ACCIDENT, SERIOUS INJURY, PROPERTY DAMAGE, AND PRODUCT FAILURE. TAKE ALL REASONABLE PRECAUTIONS TO AVOID THESE HAZARDS. CHECK WITH YOUR ORGANIZATION'S SAFETY COORDINATOR (OR POLICY) FOR PROCEDURES AND REQUIRED PROTECTIVE EQUIPMENT PRIOR TO PERFORMING ANY WORK.

Use tripods, towers, and attachments to tripods and towers only for purposes for which they are designed. Do not exceed design limits. Be familiar and comply with all instructions provided in product manuals. Manuals are available at www.campbellsci.com. You are responsible for conformance with governing codes and regulations, including safety regulations, and the integrity and location of structures or land to which towers, tripods, and any attachments are attached. Installation sites should be evaluated and approved by a qualified engineer. If questions or concerns arise regarding installation, use, or maintenance of tripods, towers, attachments, or electrical connections, consult with a licensed and qualified engineer or electrician.

General

- Protect from over-voltage.
- Protect electrical equipment from water.
- Protect from electrostatic discharge (ESD).
- Protect from lightning.
- Prior to performing site or installation work, obtain required approvals and permits. Comply with all governing structure-height regulations.
- Use only qualified personnel for installation, use, and maintenance of tripods and towers, and any attachments to tripods and towers. The use of licensed and qualified contractors is highly recommended.
- Read all applicable instructions carefully and understand procedures thoroughly before beginning work.
- Wear a **hardhat** and **eye protection**, and take **other appropriate safety precautions** while working on or around tripods and towers.
- **Do not climb** tripods or towers at any time, and prohibit climbing by other persons. Take reasonable precautions to secure tripod and tower sites from trespassers.
- Use only manufacturer recommended parts, materials, and tools.

Utility and Electrical

- **You can be killed** or sustain serious bodily injury if the tripod, tower, or attachments you are installing, constructing, using, or maintaining, or a tool, stake, or anchor, come in **contact with overhead or underground utility lines**.
- Maintain a distance of at least one-and-one-half times structure height, 6 meters (20 feet), or the distance required by applicable law, **whichever is greater**, between overhead utility lines and the structure (tripod, tower, attachments, or tools).
- Prior to performing site or installation work, inform all utility companies and have all underground utilities marked.
- Comply with all electrical codes. Electrical equipment and related grounding devices should be installed by a licensed and qualified electrician.
- Only use power sources approved for use in the country of installation to power Campbell Scientific devices.

Elevated Work and Weather

- Exercise extreme caution when performing elevated work.
- Use appropriate equipment and safety practices.
- During installation and maintenance, keep tower and tripod sites clear of un-trained or non-essential personnel. Take precautions to prevent elevated tools and objects from dropping.
- Do not perform any work in inclement weather, including wind, rain, snow, lightning, etc.

Maintenance

- Periodically (at least yearly) check for wear and damage, including corrosion, stress cracks, frayed cables, loose cable clamps, cable tightness, etc. and take necessary corrective actions.
- Periodically (at least yearly) check electrical ground connections.

Internal Battery

- Be aware of fire, explosion, and severe-burn hazards.
- Misuse or improper installation of the internal lithium battery can cause severe injury.
- Do not recharge, disassemble, heat above 100 °C (212 °F), solder directly to the cell, incinerate, or expose contents to water. Dispose of spent batteries properly.

WHILE EVERY ATTEMPT IS MADE TO EMBODY THE HIGHEST DEGREE OF SAFETY IN ALL CAMPBELL SCIENTIFIC PRODUCTS, THE CUSTOMER ASSUMES ALL RISK FROM ANY INJURY RESULTING FROM IMPROPER INSTALLATION, USE, OR MAINTENANCE OF TRIPODS, TOWERS, OR ATTACHMENTS TO TRIPODS AND TOWERS SUCH AS SENSORS, CROSSARMS, ENCLOSURES, ANTENNAS, ETC.



Global Sales & Support Network

A worldwide network to help meet your needs



Campbell Scientific Regional Offices

Australia

Location: Garbutt, QLD Australia
Phone: 61.7.4401.7700
Email: info@campbellsci.com.au
Website: www.campbellsci.com.au

Brazil

Location: São Paulo, SP Brazil
Phone: 11.3732.3399
Email: vendas@campbellsci.com.br
Website: www.campbellsci.com.br

Canada

Location: Edmonton, AB Canada
Phone: 780.454.2505
Email: dataloggers@campbellsci.ca
Website: www.campbellsci.ca

China

Location: Beijing, P. R. China
Phone: 86.10.6561.0080
Email: info@campbellsci.com.cn
Website: www.campbellsci.com.cn

Costa Rica

Location: San Pedro, Costa Rica
Phone: 506.2280.1564
Email: info@campbellsci.com
Website: www.campbellsci.com

France

Location: Vincennes, France
Phone: 0033.0.1.56.45.15.20
Email: info@campbellsci.fr
Website: www.campbellsci.fr

Germany

Location: Bremen, Germany
Phone: 49.0.421.460974.0
Email: info@campbellsci.de
Website: www.campbellsci.de

India

Location: New Delhi, DL India
Phone: 91.11.46500481.482
Email: info@campbellsci.in
Website: www.campbellsci.in

South Africa

Location: Stellenbosch, South Africa
Phone: 27.21.8809960
Email: sales@campbellsci.co.za
Website: www.campbellsci.co.za

Spain

Location: Barcelona, Spain
Phone: 34.93.2323938
Email: info@campbellsci.es
Website: www.campbellsci.es

Thailand

Location: Bangkok, Thailand
Phone: 66.2.719.3399
Email: info@campbellsci.asia
Website: www.campbellsci.asia

UK

Location: Shepshed, Loughborough, UK
Phone: 44.0.1509.601141
Email: sales@campbellsci.co.uk
Website: www.campbellsci.co.uk

USA

Location: Logan, UT USA
Phone: 435.227.9120
Email: info@campbellsci.com
Website: www.campbellsci.com