

INSTRUCTION MANUAL



RAWS-F Remote Automated Weather Station for Fire Weather

Revision: 12/13



Copyright © 2006-2013
Campbell Scientific, Inc.

Warranty

“PRODUCTS MANUFACTURED BY CAMPBELL SCIENTIFIC, INC. are warranted by Campbell Scientific, Inc. (“Campbell”) to be free from defects in materials and workmanship under normal use and service for twelve (12) months from date of shipment unless otherwise specified in the corresponding Campbell pricelist or product manual. Products not manufactured, but that are re-sold by Campbell, are warranted only to the limits extended by the original manufacturer. Batteries, fine-wire thermocouples, desiccant, and other consumables have no warranty. Campbell’s obligation under this warranty is limited to repairing or replacing (at Campbell’s option) defective products, which shall be the sole and exclusive remedy under this warranty. The customer shall assume all costs of removing, reinstalling, and shipping defective products to Campbell. Campbell will return such products by surface carrier prepaid within the continental United States of America. To all other locations, Campbell will return such products best way CIP (Port of Entry) INCOTERM® 2010, prepaid. This warranty shall not apply to any products which have been subjected to modification, misuse, neglect, improper service, accidents of nature, or shipping damage. This warranty is in lieu of all other warranties, expressed or implied. The warranty for installation services performed by Campbell such as programming to customer specifications, electrical connections to products manufactured by Campbell, and product specific training, is part of Campbell’s product warranty. **CAMPBELL EXPRESSLY DISCLAIMS AND EXCLUDES ANY IMPLIED WARRANTIES OF MERCHANTABILITY OR FITNESS FOR A PARTICULAR PURPOSE.** Campbell is not liable for any special, indirect, incidental, and/or consequential damages.”

Assistance

Products may not be returned without prior authorization. The following contact information is for US and international customers residing in countries served by Campbell Scientific, Inc. directly. Affiliate companies handle repairs for customers within their territories. Please visit www.campbellsci.com to determine which Campbell Scientific company serves your country.

To obtain a Returned Materials Authorization (RMA), contact CAMPBELL SCIENTIFIC, INC., phone (435) 227-9000. After an application engineer determines the nature of the problem, an RMA number will be issued. Please write this number clearly on the outside of the shipping container. Campbell Scientific's shipping address is:

CAMPBELL SCIENTIFIC, INC.

RMA# _____
815 West 1800 North
Logan, Utah 84321-1784

For all returns, the customer must fill out a "Statement of Product Cleanliness and Decontamination" form and comply with the requirements specified in it. The form is available from our web site at www.campbellsci.com/repair. A completed form must be either emailed to repair@campbellsci.com or faxed to (435) 227-9106. Campbell Scientific is unable to process any returns until we receive this form. If the form is not received within three days of product receipt or is incomplete, the product will be returned to the customer at the customer's expense. Campbell Scientific reserves the right to refuse service on products that were exposed to contaminants that may cause health or safety concerns for our employees.

Table of Contents

PDF viewers: These page numbers refer to the printed version of this document. Use the PDF reader bookmarks tab for links to specific sections.

1. Introduction	1
2. Getting Started	3
3. Station Siting and Orientation	6
3.1 General Description	6
3.2 Air Temperature and Relative Humidity	6
3.3 Precipitation	7
3.4 Solar Radiation.....	7
3.5 Wind Speed and Direction	7
3.6 Barometric Pressure (optional).....	7
3.7 Fuel Moisture and Fuel Temperature (optional)	7
4. Sensor Maintenance, Calibration, and Troubleshooting	7
4.1 Maintenance	7
4.2 Air Temperature and Relative Humidity	8
4.2.1 General Description	8
4.2.2 Wiring	9
4.2.3 Maintenance	9
4.2.4 Calibration.....	9
4.2.5 Troubleshooting	9
4.3 Rain Gage.....	9
4.3.1 General Description	9
4.3.2 Wiring	10
4.3.3 Maintenance.....	10
4.3.4 Calibration.....	10
4.3.5 Troubleshooting	11
4.4 Solar Radiation.....	11
4.4.1 General Description	11
4.4.2 Wiring	12
4.4.3 Maintenance	12
4.4.4 Calibration.....	12
4.4.5 Troubleshooting	12
4.5 Wind Speed and Direction	13
4.5.1 Wind Sensor.....	13
4.5.1.1 General Description.....	13
4.5.1.2 Wiring	14
4.5.1.3 Maintenance	14
4.5.1.4 Calibration.....	14
4.5.1.5 Troubleshooting	14

4.5.2	2-D WindSonic (optional)	14
4.5.2.1	General Description	14
4.5.2.2	Wiring	15
4.5.2.3	Maintenance	15
4.5.2.4	Calibration	15
4.5.2.5	Troubleshooting	16
4.6	Barometric Pressure (optional)	16
4.6.1	General Description	16
4.6.2	Wiring	16
4.6.3	Maintenance	17
4.6.4	Calibration	17
4.6.5	Troubleshooting	17
4.7	Fuel Moisture and Fuel Temperature (optional)	17
4.7.1	General Description	17
4.7.2	Wiring	18
4.7.3	Maintenance	18
4.7.4	Calibration	19
4.7.5	Troubleshooting	19

5. Equipment Maintenance, Calibration, and Troubleshooting 19

5.1	Solar Panels	19
5.1.1	General Description	19
5.1.2	Wiring	19
5.1.3	Maintenance	20
5.1.4	Calibration	20
5.1.5	Troubleshooting	20
5.2	Charger/Regulator	20
5.2.1	General Description	20
5.2.2	Wiring	21
5.2.3	Maintenance	21
5.2.4	Calibration	21
5.2.5	Troubleshooting	21
5.3	Battery	22
5.3.1	General Description	22
5.3.2	Wiring	22
5.3.3	Maintenance	22
5.3.4	Calibration	22
5.3.5	Troubleshooting	23
5.4	GOES Transmitter (Optional)	23
5.4.1	General Description	23
5.4.2	Wiring	24
5.4.3	Maintenance	24
5.4.4	Calibration	25
5.4.5	Troubleshooting	25
5.5	CR1000 Keyboard/Display	25
5.5.1	General Description	25
5.5.2	Wiring	25
5.5.3	Maintenance	26
5.5.4	Calibration	26
5.5.5	Troubleshooting	26
5.6	CR1000 Datalogger	26
5.6.1	General Description	26
5.6.2	Wiring	27

5.6.3	Maintenance	27
5.6.4	Calibration.....	27
5.6.5	Troubleshooting	27
6.	Desiccant.....	27
7.	References	28
8.	RAWS Orientation.....	28
8.1	Determining True North and Sensor Orientation	28
8.2	USGS Web Calculator	30

Appendices

A.	Assemble the RAWS-F Station	A-1
B.	Transport Cases (Optional).....	B-1

Figures

1-1.	Color-coded, keyed connector panel	1
1-2.	RAWS-F Quick Deployment Weather Station. Some wiring not shown.....	2
2-1.	Inside environmental enclosure (optional equipment shown)	4
4-1.	Air temperature and relative humidity	8
4-2.	Rain gage and CS300-QD pyranometer	10
4-3.	Pyranometer	11
4-4.	Wind sensor.....	13
4-5.	2-D WindSonic	15
4-6.	Barometric pressure	16
4-7.	CS516-QD Fuel Moisture/Fuel Temperature	18
5-1.	12-volt charger/regulator	20
5-2.	GOES transmitter	24
5-4.	CR1000 Keyboard/Display	25
5-5.	CR1000 and printed circuit wiring panel	26
5-6.	Printed circuit board wiring panel connector ID	27
8-1.	Magnetic declination for the contiguous United States	29
8-2.	A declination angle east of True North (positive) is subtracted from 360 (0) degrees to find True North	30
8-3.	A declination angle west of True North (negative) is subtracted from 0 (360) degrees to find True North	30
8-4.	USGS web calculator	31

Tables

2-1.	Public Variables	5
4-1.	TEMP/RH Connector (color coded orange).....	9
4-2.	PRECIP Connector (color coded blue)	10
4-3.	SOLAR RAD SDI-12 Connector (color coded green).....	12
4-4.	WS/WD Connector (color coded red)	14

4-5.	SDI-12 Connector (color coded yellow).....	15
4-6.	CS100-QD Wiring.....	16
4-7.	FM/FT Connector (color coded brown)	18
5-1.	GOES Transmitter Connections	24

RAWS-F Remote Automated Weather Station for Fire Weather

1. Introduction

The RAWS-F Fire Weather Quick Deployment Station is a lightweight, pre-configured station that can be set up in less than 10 minutes—without tools (see Section 2, *Getting Started*). The aluminum environmental enclosure houses a 12 V rechargeable battery and a CR1000 datalogger mounted to a 6 ft tripod. The outside of the enclosure has color-coded, keyed connectors (FIGURE 1-1) for attaching the sensors. Besides the connectors, a wiring panel is included allowing the measurement of additional sensors. The RAWS-F typically communicates via our GOES satellite transmitter. It is also compatible with other communication equipment such as telephones, digital cellular transceivers, and radios. This station is ideal for prescribed burns or other temporary installations. The RAWS-F Quick Deployment Weather Station is shown in FIGURE 1-2.

Specifications are available from our web site at www.campbellsci.com.

For “sensors specifications,” click on “Products”, select “Sensors” and go to the sensor manual for specifications. For “equipment specifications”, enter the part number in the “Search” box on the website mentioned above and go to the equipment manual for specifications.

NOTE

Equipment and sensor specifications are provided on the ResourceDVD which ships with the RAWS-F.

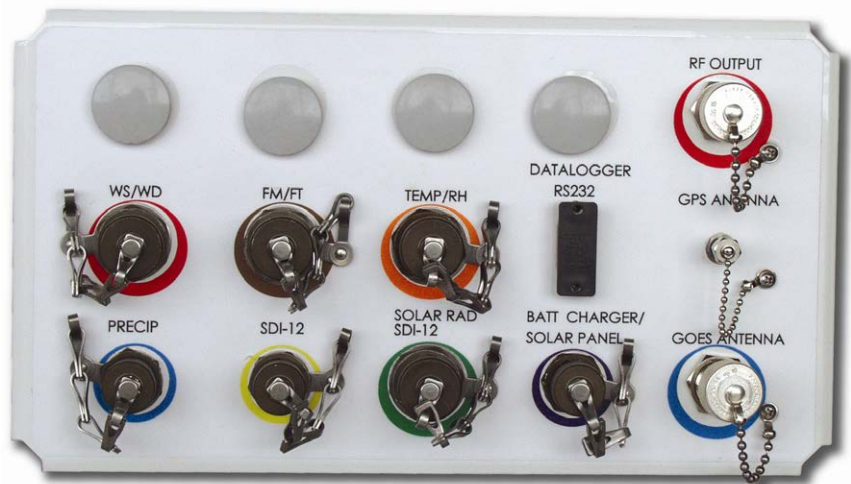

FIGURE 1-1. Color-coded, keyed connector panel

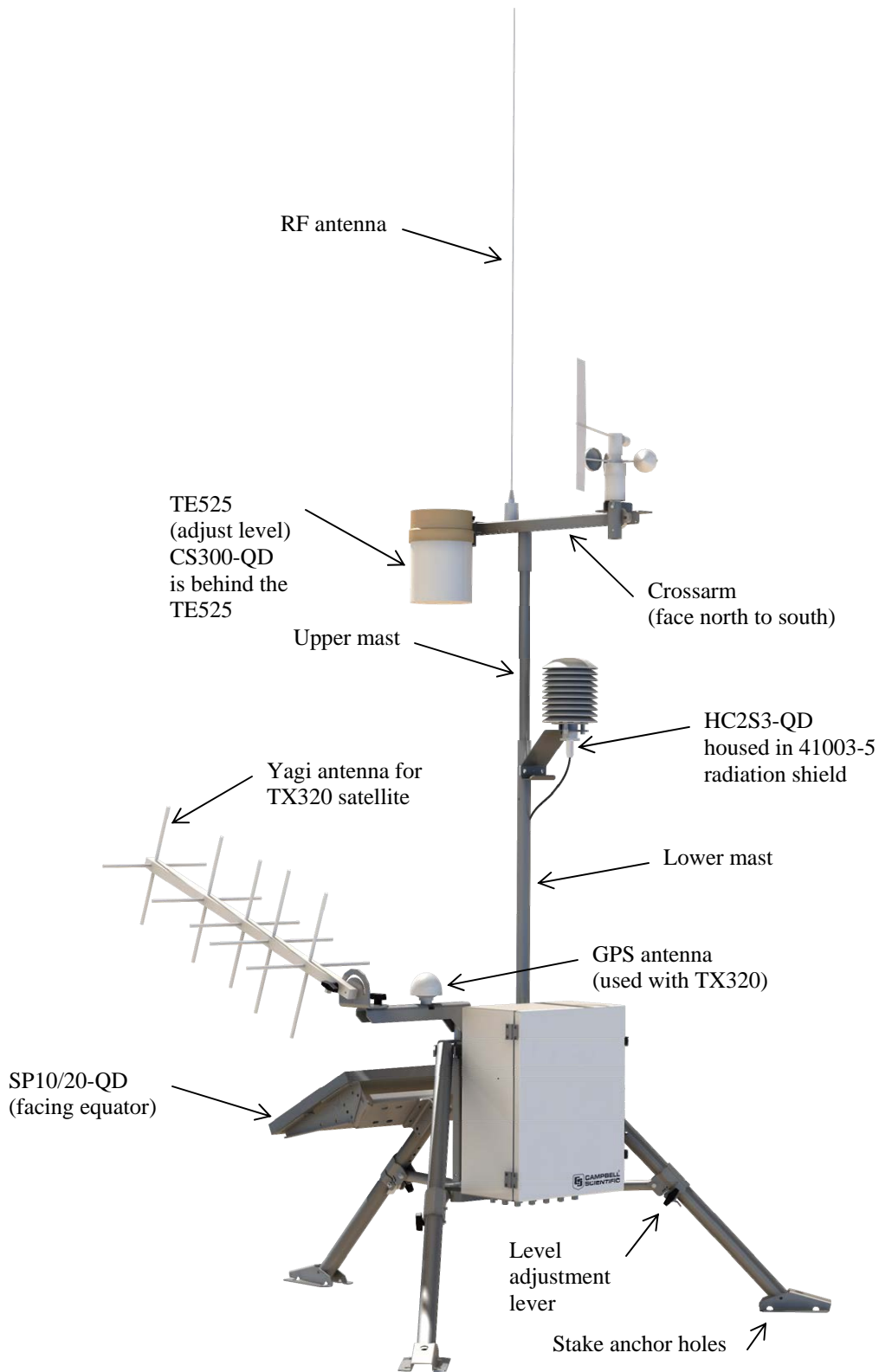

FIGURE 1-2. RAWS-F Quick Deployment Weather Station. Some wiring not shown.

2. Getting Started

Set up and test your station before field deployment (Appendix A).

Level the RAWS to ensure the sensors are level. Level the rain gage by adjusting the rain gage leveling screw. A post level and compass ship with the station (pn 16670).

NOTE Keep this manual and the CR1000KD Keyboard Display with the RAWS.

Review the station siting and orientation section before field deployment. If a problem is encountered, review the equipment wiring and troubleshooting sections in this manual.

After siting and leveling the RAWS, open the enclosure and (1) connect the battery cable and (2) verify the CH100 switch is in the 'on' position.

NOTE When this equipment is not in use (for example, transport or storage), disconnect battery cable to the CH100.

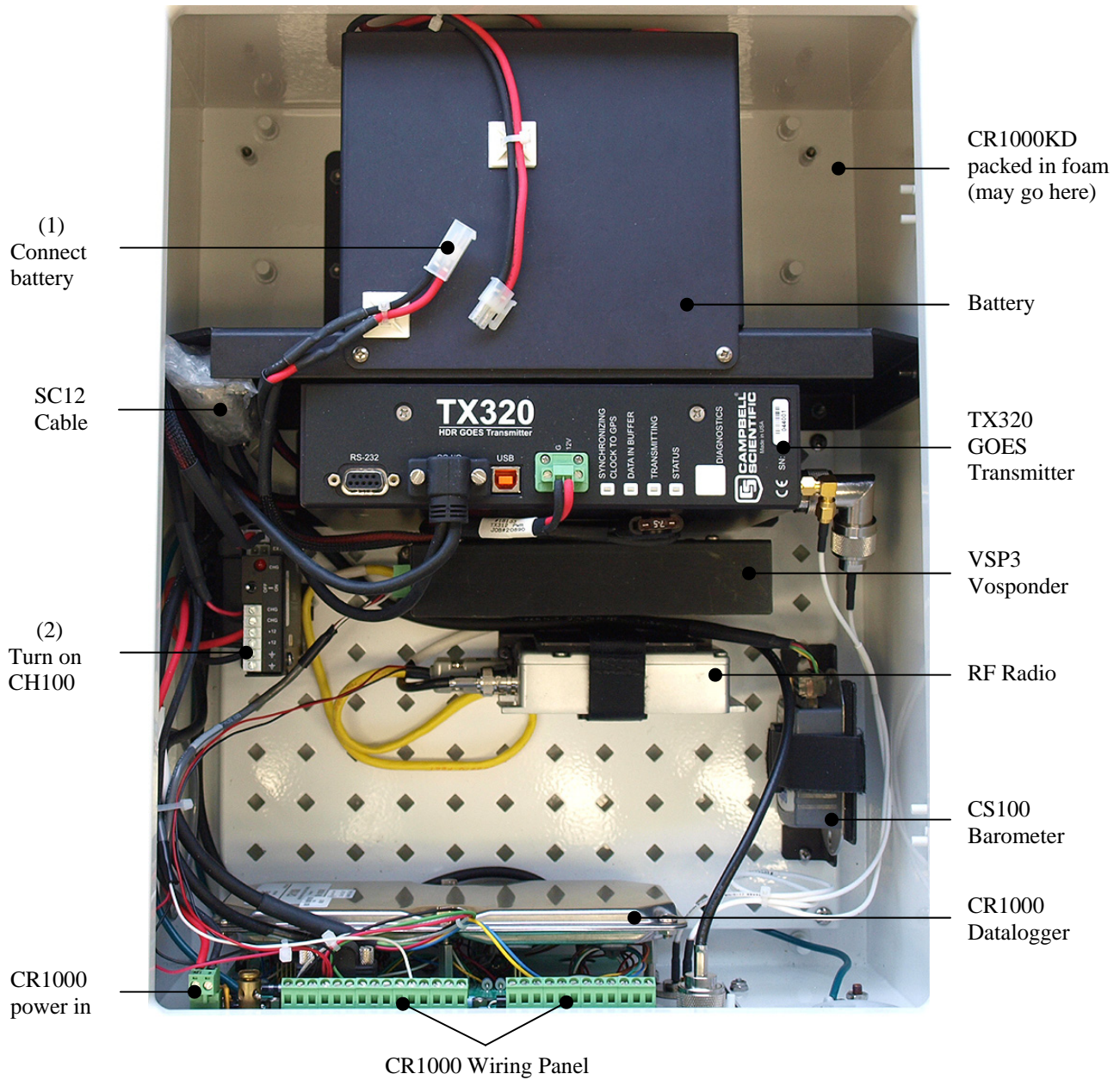

FIGURE 2-1. Inside environmental enclosure (optional equipment shown)

NOTE

The RAWS-F comes pre-programmed, but this program does NOT include user-specific GOES-ID parameters. Please contact a Campbell Scientific Applications Engineer for programming assistance. Campbell Scientific company contact information is listed on the last page of this manual.

NOTE

Use the CR1000KD Keyboard Display to see the “Public Variables” shown in TABLE 2-1.



- Connect the CR1000KD Keyboard Display to the CS I/O connector (FIGURE 5-5) or SC12 Cable (FIGURE 2-1)
- Press any key for the CR1000KD Power up Screen
- Press Enter to move down a menu (Press Esc to move up a menu)
- (Press up/down arrow to select item)
- Select Data, press Enter
- Select Real Time Tables, press Enter
- Select Public, press Enter
- Press up/down arrow to see the Public Variables listed in TABLE 2-1

Press any key for Power up Screen
 Press ^ to turn on/off backlight
 Press <> to adjust contrast

TABLE 2-1. Public Variables

Number	Name	Function
	Sensor Variables	
1	Batt_Volt	System power supply voltage
2	AirTempF	HC2S3 air temperature in degrees F
3	RH	HC2S3 relative humidity in percent
4	TdewF	Dewpoint in degrees F, calculated from HC2S3 data
5	SlrW	Solar radiation in watts, pyranometer
6	Rain_in	Temporary rain, cleared every scan
7	RainTot	TE525 cumulative rain fall in inches
8	WS_mph	Wind speed in MPH
9	WindDir	Wind direction
10	WSDiag	Only for WindSonic data, zero otherwise
11	MaxWS	MaxWS, reset 2 minutes before transmit
12	MaxWD	Direction of wind during max wind speed
13	SlrMJ	Solar radiation in MJoules
14	BP_inHg	Hourly — barometric pressure, inHg
15	BPelev_ft	Elevation, to correct barometric pressure
16	FuelT_F	Hourly — fuel temperature in degrees F
17	FuelM	Hourly — fuel moisture, % moisture by weight
	GOES Variables	
18	CountDwn	True or False: True indicates GPS fix good and program is collecting data. False until GPS fix is obtained

19	Clockgood	True or False: True after GPS fix and CR1000 clock has been set to match TX320 clock
20	TimeToXmit	Seconds until transmit time. Indicates CR1000 and TX320 are properly setup and running
21	SWR	Standing Wave Ratio (SWR), only after a transmission. Indicates condition of antenna and cable. SWR should be less than 2.0
22	FwdPower	Forward power in dBm, should be about 37
23	RefPower	Reflected power in dBm, should be about 25 or less
24	RC_Data	Only valid after first transmission. Anything other than zero is a problem
25	Setup_RC	Indicates if CR1000 could setup TX320. Zero is success or has not run

3. Station Siting and Orientation

3.1 General Description

Selecting an appropriate site for the RAWS is critical in order to obtain accurate meteorological data. In general, the site should be representative of the general area of interest and away from the influence of obstructions such as buildings and trees.

NOTE See Section 7, *References*, for siting references.

WARNING **If any part of the weather station comes in contact with power lines, you could be killed. Contact local utilities for the location of buried utility lines before digging or driving ground rods.**

3.2 Air Temperature and Relative Humidity

A temperature and relative humidity (RH) sensor should be located over an open level area at least 9 m in diameter (EPA). The surface should be covered by short grass, or where grass does not grow, the natural earth surface. The sensor must be housed inside a radiation shield and adequately ventilated.

Situations to avoid include:

- large industrial heat sources
- rooftops
- steep slopes
- sheltered hollow
- high vegetation
- shaded areas
- swamps
- areas where snow drifts occur
- low places holding standing water after rains

3.3 Precipitation

A rain gage should be located over an open level area covered by short grass, or where grass does not grow, the natural earth surface. Level the RAWS station to ensure the sensors are level. Level the rain gage by adjusting the rain gage leveling screw. A post level and compass ship with the RAWS (pn 16770).

NOTE Take off the funnel and remove the rubber band securing the tipping bucket mechanism during transport.

3.4 Solar Radiation

A solar radiation sensor should be located to avoid shadows on the sensor at any time. Orient the RAWS facing the equator, minimizing the chance of shading from other weather station structures. Reflective surfaces and sources of artificial radiation should be avoided. Level the RAWS to ensure the solar radiation sensor is level.

3.5 Wind Speed and Direction

A wind sensor should be located over open level terrain and at a distance of at least ten times (EPA) the height of any nearby building, tree, or other obstruction.

3.6 Barometric Pressure (optional)

The barometric pressure sensor is mounted to the back plate inside the RAWS environmental enclosure.

3.7 Fuel Moisture and Fuel Temperature (optional)

The fuel moisture and fuel temperature sensor should be left outside at the field site continually exposed to the same conditions as the forest fuels. The fuel moisture and fuel temperature dowel rods absorb and desorb moisture from its surroundings. Install the probes horizontally on the mounting stake and face the sensors towards the equator above a representative forest floor duff layer. Place the sensor away from foot traffic areas.

4. Sensor Maintenance, Calibration, and Troubleshooting

4.1 Maintenance

Proper maintenance of weather station components is essential to obtain accurate data. Equipment must be in good operating condition, which requires a program of regular inspection and maintenance. Routine and simple maintenance can be accomplished by the person in charge of the weather station. More difficult maintenance, such as sensor calibration, sensor performance testing (for example, bearing torque), and sensor component replacement, generally requires sending the instrument to Campbell Scientific.

A station log should be maintained for each weather station that includes equipment model, serial numbers, and maintenance that was performed.

NOTE Contact Campbell Scientific, phone (435) 227-9000, for an RMA number before returning sensor or equipment for service.

4.2 Air Temperature and Relative Humidity

4.2.1 General Description

Rotronic's HydroClip2 Air Temperature and Relative Humidity Sensor (pn HC2S3-QD) shown in FIGURE 4-1 contains a Platinum Resistance Thermometer (PRT) and a Rotronic's IN1 capacitive sensor. The probe has a voltage output for each sensor.



FIGURE 4-1. Air temperature and relative humidity

4.2.2 Wiring

The HC2S3 attaches to the connector labeled TEMP/RH, which is color coded orange. This sensor is internally wired from the RAWS connector panel to the CR1000.

Connector Pin	Description	CR1000 Terminal
A	Temperature H	1L
B	Sensor Excitation	VX1
C	Sensor Signal L/ \oplus	\oplus
D	Power Ground	G
E	RH Signal	1H
F	Switched 12 V	SW_12V

4.2.3 Maintenance

The temp/RH sensor requires minimal maintenance. Check monthly to make sure the radiation shield is free from debris. The filter at the end of the sensor should also be checked for contaminants. When installed in close proximity to the ocean or other bodies of salt water, a coating of salt may build up on the radiation shield, sensor, filter and even the RH chip. A buildup of salt on the filter or RH chip will delay or destroy the response to atmospheric humidity. The filter can be rinsed gently in distilled water. If necessary, the chip can be removed and rinsed as well. Do not scratch the RH chip while cleaning.

4.2.4 Calibration

Recalibrate the temp/RH sensor annually. Obtain an RMA number before returning this sensor to Campbell Scientific for recalibration.

4.2.5 Troubleshooting

If a problem is suspected, check the sensor cable. Disconnect the connector and look for damaged pins. Verify that the sensor body is connected to the sensor head. Under the filter assembly, verify the sensors are connected but not touching. Try connecting a substitute sensor. Obtain an RMA number before returning this sensor to Campbell Scientific for repair.

4.3 Rain Gage

4.3.1 General Description

The Texas Electronics Rain Gage (pn TE525-QD) shown in FIGURE 4-2 is an adaptation of a Weather Bureau tipping bucket rain gage. The rain gage has a 6 inch collector. The rain gage sensor output has a switch closure for each bucket tip. Level the rain gage by adjusting the rain gage leveling screw. A post level and compass (pn 16670) ship with the station.



FIGURE 4-2. Rain gage and CS300-QD pyranometer

4.3.2 Wiring

The TE525-LQ attaches to the connector labeled PRECIP, which is color coded blue. This sensor is internally wired from the RAWS connector panel to the CR1000.

Connector Pin	Description	CR1000 Terminal
A	Tipping Bucket	C6
B	5 V	5V
C	Ground	G

4.3.3 Maintenance

The rain gage funnel and bucket mechanism must be kept clean. Routinely check for and remove any foreign material, dust, insects, etc.

4.3.4 Calibration

Recalibrate the rain gage annually. Obtain an RMA number before returning this sensor to Campbell Scientific for recalibration.

4.3.5 Troubleshooting

If a problem is suspected, check the sensor cable. Disconnect the connector and use a digital volt meter (DVM) to check the resistance between Pin A (sensor signal) and Pin C (sensor ground). The resistance should read as an open circuit until you move the rain gage tipping mechanism where the magnet swings past the reed relay. Try connecting a substitute sensor. Obtain an RMA number before returning this sensor to Campbell Scientific for repair.

4.4 Solar Radiation

4.4.1 General Description

The Apogee Pyranometer (pn CS300-QD) shown in FIGURE 4-3 measures incoming solar radiation with a silicon photovoltaic detector mounted in a cosine-corrected head. The detector outputs current; a shunt resistor in the sensor converts the signal from current to voltage. During the night, the CS300-QD may read slightly negative incoming solar radiation. The negative signal is caused by RF noise.



FIGURE 4-3. Pyranometer

4.4.2 Wiring

The CS300-LQ attaches to the connector labeled SOLAR RAD SDI-12; this connector is color coded green. The pyranometer is internally wired from the RAWS connector panel to the CR1000.

TABLE 4-3. SOLAR RAD SDI-12 Connector (color coded green)

Connector Pin	Description	CR1000 Terminal
A	Solar Sensor +	3H
B	Solar Sensor -	3L shorted to \perp
C	Solar Sensor Ground	\perp
D	SDI-12 Ground	G (used for a second SDI-12 sensor)
E	SDI-12 Signal	C5 (used for a second SDI-12 sensor)
F	SDI-12 12 V	12V (used for a second SDI-12 sensor)

4.4.3 Maintenance

The pyranometer must be kept clean. Routinely check for and remove any foreign material, dust or debris on the sensor head. The debris can be removed with a blast of compressed air or with a soft bristle, camel hair brush. Handle the sensor carefully when cleaning. Be careful not to scratch the surface of the sensor.

4.4.4 Calibration

Recalibrate the pyranometer annually. Obtain an RMA number before returning this sensor to Campbell Scientific for recalibration.

4.4.5 Troubleshooting

If a problem is suspected, check the sensor cable. Disconnect the connector and use a DVM to check the voltage between Pin A Solar Sensor (+) and Pin B Solar Sensor (-). The voltage should be 0 to 200 mV for 0 to 1000 W m⁻² radiation. No voltage indicates a problem with either the photodiode or the shunt resistor, both of which are potted in the sensor head and cannot be serviced. Try connecting a substitute sensor. Obtain an RMA number before returning this sensor to Campbell Scientific for repair.

4.5 Wind Speed and Direction

4.5.1 Wind Sensor

4.5.1.1 General Description

The Met One Wind Sensor (pn 034B-QD) shown in FIGURE 4-4 is an integrated cup anemometer and wind vane. The anemometer consists of three cups that sense the wind speed. These cups rotate on a vertical shaft that magnetically activates a sealed reed switch. The reed switch opens and closes at a rate proportional to wind speed. The wind direction is sensed by a vane. The vane drives a 10 k Ω potentiometer. The wind speed sensor outputs a pulse. The wind direction sensor outputs a voltage.



FIGURE 4-4. Wind sensor

4.5.1.2 Wiring

The 034B-LQ attaches to the connector labeled WS/WD; this connector is color coded red. The sensor is internally wired from the RAWS connector panel to the CR1000.

Connector Pin	Description	CR1000 Terminal
A	Sensor Ground	\equiv
B	Wind Direction Excitation	VX2
C	Wind Direction Signal	2H
D	Power Ground	G
E	+12 V Power	12V
F	Wind Speed Signal	P1

4.5.1.3 Maintenance

The wind vane tail must be attached to the hub. Maintain the tail assembly with the tail vertical. Extra labels are included with the wind sensor to recover the holes if the sensor has to be disassembled for maintenance. The set screw holes must be covered with these labels to prevent corrosion and ensure the warranty. Verify free movement of the cup anemometer and wind vane.

4.5.1.4 Calibration

Recalibrate the wind sensor annually. Obtain an RMA number before returning this sensor to Campbell Scientific for recalibration.

4.5.1.5 Troubleshooting

If a problem is suspected, check the sensor cable. Disconnect the connector and look for damaged pins. Verify free movement of the cup anemometer and wind vane. Try connecting a substitute sensor. Obtain an RMA number before returning this sensor to Campbell Scientific for repair.

4.5.2 2-D WindSonic (optional)

4.5.2.1 General Description

The Gill Instruments 2-D Sonic Wind Sensor (pn WindSonic4-QD) shown in FIGURE 4-5 is an ultrasonic anemometer for measuring wind direction and wind speed. It uses two pairs of orthogonally oriented transducers to sense the horizontal wind. The transducers bounce the ultrasonic signal from a hood, minimizing the effects of transducer shadowing and flow distortion. The 2-D Sonic Wind Sensor makes wind measurements at a frequency of 1 Hz and outputs a SDI-12 signal to the datalogger.



FIGURE 4-5. 2-D WindSonic

4.5.2.2 Wiring

The WindSonic4-LQ attaches to the connector labeled SDI-12; this connector is color coded red. The sensor is internally wired from the RAWS connector panel to the CR1000.

Connector Pin	Description	CR1000 Terminal
A	SDI-12 Signal	C7
B	12 V	12V
C	Power Ground	G

4.5.2.3 Maintenance

There are no user-serviceable parts on the 2-D Sonic Wind Sensor. Keep the transducer paths clear of any obstructions. When clearing the transducer paths, do not remove the “rubber” caps on each of the transducers.

4.5.2.4 Calibration

Recalibrate the 2-D Sonic Wind Sensor annually. Obtain an RMA number before returning this sensor to Campbell Scientific for recalibration.

4.5.2.5 Troubleshooting

If a problem is suspected, check the sensor cable. Disconnect the connector and look for damaged pins. Try connecting a substitute sensor. Should the 2-D sonic sensor be damaged, fails to output data, or sends a nonzero diagnostic, obtain an RMA number before returning this sensor to Campbell Scientific for repair.

4.6 Barometric Pressure (optional)

4.6.1 General Description

The Setra Barometric Pressure Sensor (pn CS100) shown in FIGURE 4-6 is a capacitive pressure transducer that uses Setra's electrical capacitor technology for barometric pressure measurements over the 600 to 1100 millibar range. The CS100 is supplied in the triggered mode, in which the datalogger switches 12 Vdc power to the barometer before the measurement. The datalogger then powers down the barometer after the measurement to conserve power.



FIGURE 4-6. Barometric pressure

4.6.2 Wiring

The CS100 is mounted inside the RAWS environmental enclosure and the sensor wires are attached to the CR1000 printed circuit board wiring panel.

TABLE 4-6. CS100-QD Wiring	
CS100 Wire Color	CR1000 Terminal
Blue	5L
Yellow	⊥
Red	12V
Clear	G
Black	G
Green	C4

4.6.3 Maintenance

Since the CS100 is semi-sealed, minimum maintenance is required. Change the RAWS enclosure desiccant regularly; failure to protect the CS100 sensor from condensation may result in permanent damage.

CAUTION

The CS100 is sensitive to static when the back plate is removed. To avoid damage, take adequate anti-static measures when handling this sensor.

4.6.4 Calibration

Recalibrate the CS100 Barometric Pressure Sensor annually. Obtain an RMA number before returning this sensor to Campbell Scientific for recalibration.

4.6.5 Troubleshooting

If a problem is suspected, verify the sensor wires are securely fastened to the CS100 connector and the CR1000 printed circuit board wiring panel. Use a DVM to check the sensor output voltage on the CR1000 printed circuit board wiring panel (0 to 2.5 Vdc) between terminals 5H and $\frac{+}{-}$.

NOTE

For the DVM test, “temporarily” move the green wire from “C4” to “5V” terminal. No voltage indicates a problem with the sensor or a bad sensor cable connection. Try connecting a substitute sensor.

Obtain an RMA number before returning this sensor to Campbell Scientific for repair.

4.7 Fuel Moisture and Fuel Temperature (optional)

4.7.1 General Description

The CS516-LQ Fuel Moisture/Fuel Temperature Sensor consists of the CS506 Fuel Moisture Probe, 26601 Fuel Moisture Stick, CS205 Fuel Temperature Stick, and 107 thermistor mounted on the 26817 Mounting Stake (see FIGURE 4-7). The fuel moisture probe provides the moisture content of a standard 10-hour fuel moisture dowel. This moisture represents the moisture content of small-diameter (10-hour time lag) forest fuels. The fuel temperature probe consists of a Ponderosa pine dowel with a bored hole and a 107 Temperature Probe inserted into the dowel. The CS205 mounts on the mounting stake with the CS506.



FIGURE 4-7. CS516-QD Fuel Moisture/Fuel Temperature

4.7.2 Wiring

The CS516-LQ attaches to the connector labeled FM/FT, which is color coded brown. This sensor is internally wired from the RAWS connector panel to the CR1000.

TABLE 4-7. FM/FT Connector (color coded brown)		
Connector Pin	Description	CR1000 Terminal
A	CS205 Temperature Signal	4L
B	Sensor Ground	⏏
C	CS205 Temperature Excitation	VX1
D	CS506 FM Enable	C8
E	CS506 FM Signal	4H
F	CS506 FM 12 V	12V

4.7.3 Maintenance

The CS506 Fuel Moisture element and 26601 dowel should be changed at least once a year with a new element in the spring. Since the characteristics of wood change so rapidly, more frequent dowel replacements may be desirable. To change the sensor element, loosen the Phillips head screws and replace with a new element. Tighten the screws after replacing the element.

The CS205 Fuel Moisture Stick should be changed annually or more frequently as required. The wood should visually appear fresh and new, not gray or discolored. The CS205 inserts into the compression fitting so that compression is applied to the split end of the stick gripping the 107 temperature probe.

4.7.4 Calibration

For most applications, it is unnecessary to calibrate the CS516-QD Fuel Moisture and Fuel Temperature Sensor. However, for those users that are interested in calibrating this sensor, please contact a Campbell Scientific Applications Engineer.

4.7.5 Troubleshooting

If a problem is suspected, check the sensor cable. Disconnect the connector and look for damaged pins. Verify the CS506 sensor element is securely fastened. Try connecting a substitute sensor. Obtain an RMA number before returning the CS516-QD sensor to Campbell Scientific for repair.

5. Equipment Maintenance, Calibration, and Troubleshooting

5.1 Solar Panels

5.1.1 General Description

The solar panel is a photovoltaic power source used for charging lead acid batteries. The SP20-QD 20 watt solar panel is used for system configurations that have higher-than-average power requirements. It is also recommended for use at higher elevations and latitudes. The solar panel should be mounted facing the equator.

The SP10-QD 10 watt solar panel is recommended for a RAWS where NO communication equipment is used. The SP20-QD 20 watt solar panel is recommended for a RAWS where communication equipment is used (for example, GOES, voice, cell phone, or radio).

NOTE

The solar panel selected for the RAWS depends on the station power requirements, specifically the communication equipment selected for the station.

The SP10-QD solar panel outputs 0.59 Amps, 8.9 Watts typical peak power.

The SP20-QD solar panel outputs 1.17 Amps, 18 Watts typical peak power.

5.1.2 Wiring

The solar panel attaches to the connector panel labeled “BATT CHARGER/SOLAR PANEL”. Inside the RAWS environmental enclosure, the “BATT CHARGER/SOLAR PANEL” connector pin A and pin B are wired to the CH100’s “CHG” and “CHG” ports. Polarity does not matter; either lead can be connected to either terminal. The CH100 has two functions: blocking any current flow from the battery to the solar panel, and limiting the source current to the battery.

5.1.3 Maintenance

An occasional cleaning of the glass improves the solar panel's efficiency.

5.1.4 Calibration

No calibration is required.

5.1.5 Troubleshooting

If a problem is suspected, the solar panel may be checked by measuring the voltage output from the solar panel. Check the voltage with a voltmeter connected between the two leads going to the CH100's "CHG" "CHG" terminals located inside the environmental enclosure (15 to 28 Vdc). There must be solar radiation incident on the panel and there must be a load connected to the solar panel. The load can be the datalogger, other equipment, or a 75 ohm resistor capable of dissipating solar panel power between the two leads. No voltage output implies a bad solar panel, regulator, or cable. The magnitude of the voltage output depends on the incident solar radiation. Check the sensor cable. Disconnect the connector and look for damaged pins. Try connecting a substitute panel. Obtain an RMA number before returning the SP10/20-QD to Campbell Scientific for repair.

5.2 Charger/Regulator

5.2.1 General Description

The 12 Volt charger/regulator (pn CH100) is a charging regulator for 12 V rechargeable batteries. The CH100 is connected to an external charging source such as an unregulated solar panel (pn SP20-QD or SP10-QD) or a wall charger (pn 29796). The CH100 has two functions: blocking any current flow from the battery to the solar panel, and limiting the source current to the battery.



FIGURE 5-1. 12-volt charger/regulator

5.2.2 Wiring

The leads from the RAWS connector panel “BATT CHARGER/SOLAR PANEL” connector COLOR CODED PURPLE are wired to the CH100 “CHG” terminals. Polarity does not matter; either lead can be connected to either terminal. The charge indicating diode should be “ON” when voltage to the charging circuitry (CHG Terminals) is present.

An internal and/or external battery can be connected to the CH100 by means of the INT (Internal) or EXT (External) connectors. The battery red lead connects to the positive battery terminal and the black lead connects to the negative terminal.

NOTE

An “external battery cable” (pn 6186) ships with the RAWS-F.

Connect 12 V power to the datalogger and/or peripherals using the “+12 and Ground” terminals. The ON-OFF switch applies power to these 12 V terminals.

WARNING

Reversal of battery polarity will damage the CH100 or battery.

CAUTION

A battery must be attached for the CH100 to function correctly as a power supply.

CAUTION

It is possible to leave two batteries connected. The battery connections are diode isolated; however, if one of the batteries fails, it could draw all the charging current and the other battery will be discharged.

5.2.3 Maintenance

There are no user-serviceable parts on the CH100. No maintenance is required.

5.2.4 Calibration

No calibration is required.

5.2.5 Troubleshooting

If a problem is suspected, the CH100 may be checked by measuring:

- input voltage between the two CHG terminals. From a solar panel, the voltage should be 15 to 28 Vdc. From the standard wall charger (pn 29796), the voltage should be 24 Vdc.
- charging output voltage (BATT INT or EXT terminal) with battery disconnected about 13.5 to 14 Vdc
- power out (+12 terminals) about 11 to 14 Vdc

No voltage output implies a bad solar panel, regulator, or battery. If problems persist, obtain an RMA number and return the device to Campbell Scientific for repair.

NOTE Power out (+12 terminals) is controlled by the CH100 ON-OFF switch position.

5.3 Battery

5.3.1 General Description

Two power supply options are offered for the RAWS-F. The -24 option includes a 24 A h sealed rechargeable battery, an external 20 W solar panel, and a CH100 regulator. The -7 option includes a 7 Ahr sealed rechargeable battery, an external 10 W solar panel, and a CH100 regulator.

WARNING **RAWS rechargeable batteries are designed to be float charged. Permanent damage occurs and battery life is shortened if the battery is allowed to discharge below 10.5 volts.**

5.3.2 Wiring

The RAWS rechargeable battery should be connected to the CH100's INT (Internal) connector. The battery red lead connects to the positive battery terminal and the black lead connects to the negative terminal. If desired, an external battery can be connected to the CH100's EXT (External) connector. An "external battery cable" (pn 6186) ships with the RAWS-F.

WARNING **Reversal of battery polarity will damage the CH100 or battery.**

CAUTION It is possible to leave two batteries connected. The battery connections are diode isolated; however, if one of the batteries fails, it could draw all the charging current and the other battery will be discharged.

5.3.3 Maintenance

There are no user-serviceable parts on the battery. No maintenance is required.

5.3.4 Calibration

No calibration is required.

5.3.5 Troubleshooting

If a problem is suspected, measure the +12 V and Ground terminal on the CR1000 printed circuit board wiring panel. Acceptable readings are +11 to +14 Vdc. Use PC200W software to collect the 1-HR data table from the CR1000 datalogger and review the historical record of battery voltage.

5.4 GOES Transmitter (Optional)

5.4.1 General Description

The High Data Rate GOES Transmitter (pn TX320) shown in FIGURE 5-2 supports one-way communication, via satellite, from a Campbell Scientific datalogger to a ground receiving station. Satellite telemetry offers a convenient communication alternative for field stations where phone systems or RF systems are impractical or rendered unreliable after a tragedy to the local infrastructure. Data transmission rates of 100, 300, and 1200 bps are supported. Because clock accuracy is critical for GOES satellite telemetry, the TX320 includes a robust, TCXO-based real-time clock and a GPS receiver.

The TX320 has two siting requirements for proper operation. The GOES antenna must have a clear view of the spacecraft. The GOES antenna is directional and should be aimed at the spacecraft; both elevation and azimuth are unique to the location of the planet and must be set. A poorly aimed antenna will cause a drop in signal strength or possibly prevent successful transmission.

For more information on the TX320 and antenna siting, go to our website at www.campbellsci.com, enter the “TX320” in the “Search” box, and go the equipment manual. The TX320 manual is also provided on the ResourceDVD which ships with the RAWS-F.

NOTE

The spacecraft specific DCP-Setup parameters for the GOES transmitter must be entered in the CR1000KD menus for the TX320 to work properly.

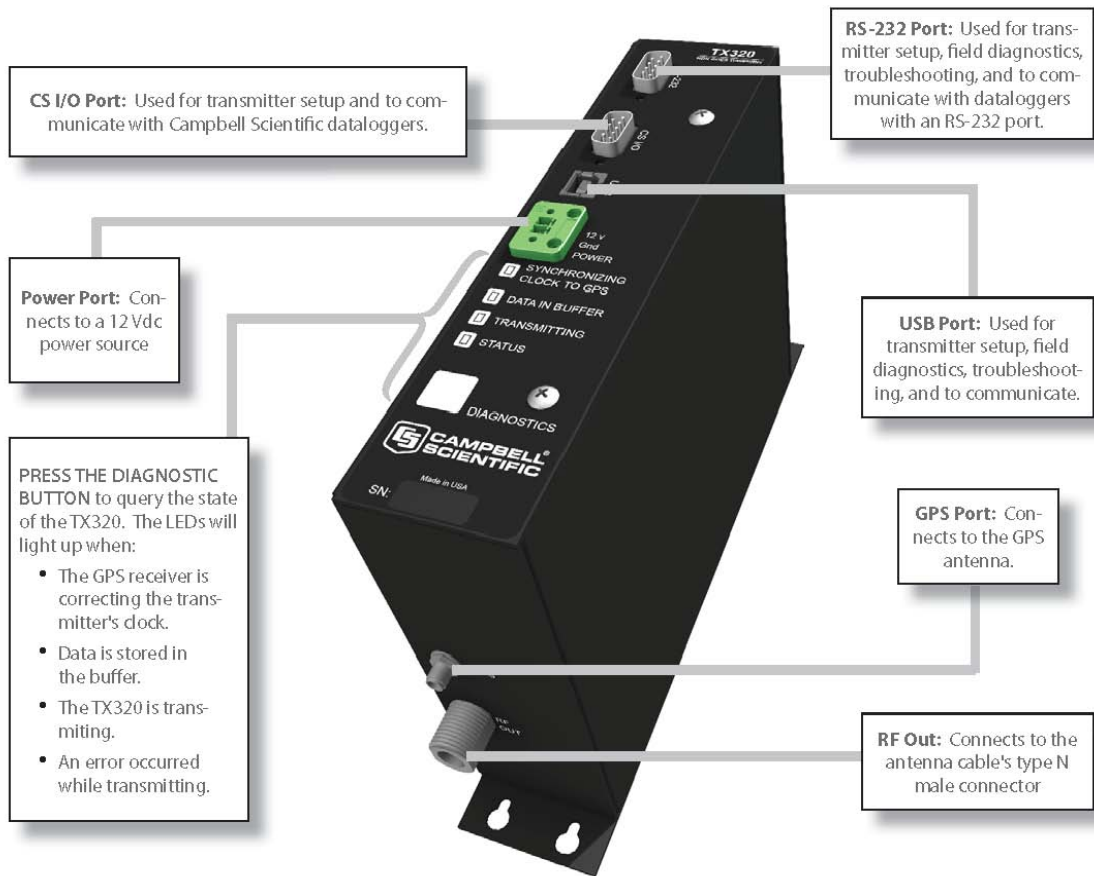

FIGURE 5-2. GOES transmitter

5.4.2 Wiring

The TX320 is mounted inside the RAWS environmental enclosure and the transmitter connections are described below.

TABLE 5-1. GOES Transmitter Connections	
TX320 Connector	Connects to
CS I/O	CR1000 CS I/O port via SC12 cable (shipped with the RAWS-F)
GPS	GPS antenna cable
RF Out	GOES antenna cable
Green Power Port	Battery Cable Junction Connector

5.4.3 Maintenance

There are no user-serviceable parts on the GOES transmitter. No maintenance is required.

5.4.4 Calibration

No calibration is required.

5.4.5 Troubleshooting

If a problem is suspected, the TX320 may be checked by measuring the +12 V and Ground terminal on the CR1000 PC-board wiring panel. Acceptable readings are +11 to +14 Vdc. Check the SC12 cable connection between the CR1000 wiring panel and the TX320. Press the TX320 diagnostic button to query the state of the transmitter. If problems persist, obtain an RMA number and return the device to Campbell Scientific for repair.

5.5 CR1000 Keyboard/Display

5.5.1 General Description

The CR1000 Keyboard/Display (pn CR1000KD) shown in FIGURE 5-3 is used to check datalogger status, to display or plot sensor readings and stored values, to enter numeric data, or to change port/flag state. The CR1000KD is powered from the CR1000 printed circuit board “CS I/O” connector via our 9-pin serial cable (pn 10873) that ships with the RAWS.

NOTE

Use the CR1000KD menus to enter GOES DCP-Setup Parameters and to select the wind speed/direction sensor on the RAWS.



FIGURE 5-3. CR1000 Keyboard/Display

5.5.2 Wiring

The CR1000KD connects to the CR1000 PC board “CS I/O” 9-Pin connector using our 9-pin serial cable (pn 10873) that ships with the RAWS.

5.5.3 Maintenance

There are no user-serviceable parts on the CR1000KD. No maintenance is required.

5.5.4 Calibration

No calibration is required.

5.5.5 Troubleshooting

If a problem is suspected, the CR1000KD may be checked by connecting the CR1000KD to the CR1000 PC board 9-Pin “CS I/O” connector using our 9-pin serial cable (pn 10873). The CR1000KD display should be visible. Check the CH100’s ON-OFF switch. If the display is not visible, check the CR1000 wiring panel for 12 volt power. If the CR1000 is unresponsive to CR1000KD key strokes, there might be a problem with the CR1000 datalogger. Obtain an RMA number before returning this equipment to Campbell Scientific for repair.

5.6 CR1000 Datalogger

5.6.1 General Description

The CR1000 shown in FIGURE 5-4 provides sensor measurement, timekeeping, data reduction, data/program storage, and control functions. The CR1000 includes 4 MB of memory for data and program storage. A lithium battery backs up the RAM and real-time clock. The CR1000 also suspends execution when primary power drops below 9.6 V, reducing the possibility of inaccurate measurements.

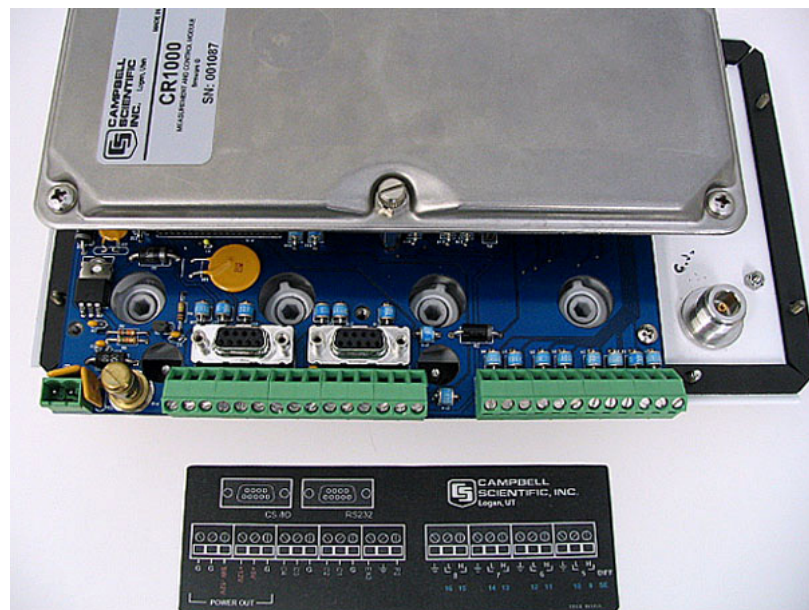

FIGURE 5-4. CR1000 and printed circuit wiring panel

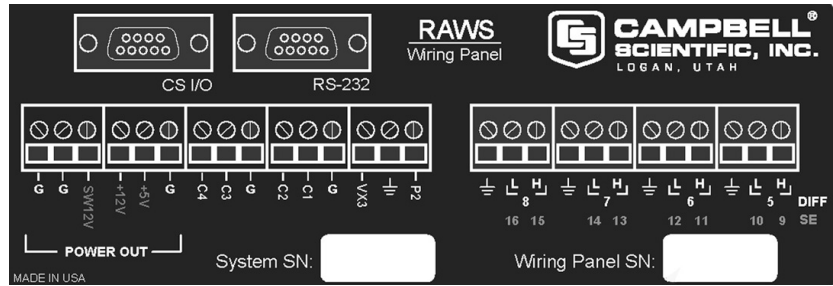

FIGURE 5-5. Printed circuit board wiring panel connector ID

5.6.2 Wiring

The CR1000 is mounted inside the RAWS environmental enclosure and fastened to the CR1000 printed circuit board wiring panel; connect 12 V power to the CR1000 printed circuit board wiring panel green power connector. The CH100’s ON-OFF switch applies power to the 12 V terminals.

5.6.3 Maintenance

There are no user-serviceable parts on the CR1000. No maintenance is required.

5.6.4 Calibration

Recalibrate the CR1000 every two years. Obtain an RMA number before returning the CR1000 to Campbell Scientific for recalibration.

5.6.5 Troubleshooting

If a problem is suspected, the CR1000 may be checked by connecting the CR1000KD to the CR1000 printed circuit board 9-Pin “CS I/O” connector using our 9-pin serial cable (pn 10873). The CR1000KD display should be visible. If the display is not visible, check the CR1000 printed circuit board for 12 volt power. If the CR1000 is unresponsive to CR1000KD key strokes, then there might be a problem with the CR1000. Contact a Campbell Scientific applications engineer for assistance. Obtain an RMA number before returning this equipment to Campbell Scientific for repair.

6. Desiccant

A humidity indicator card and desiccant packs are provided with the weather station. Place the humidity indicator card and 2 ea. desiccant packs inside the enclosure. Desiccant packets inside the enclosure should be replaced with fresh packets when the upper dot on the indicator begins to turn pink. The indicator tab does not need to be replaced unless the colored circles overrun. A humidity indicator card (pn 28878) and desiccant pack (pn 4905) may be ordered through Campbell Scientific. Desiccant packs inside of the datalogger do not require replacement under normal conditions.

7. References

General guidelines for site selection are listed below.

EPA, (1987): *On-Site Meteorological Program Guidance for Regulatory Modeling Applications*, EPA-450/4-87-013, Office of Air Quality Planning and Standards, Research Triangle Park, NC, 27711.

WMO, (1983): *Guide to Meteorological Instruments and Methods of Observation*, World Meteorological Organization, No. 8, 5th edition, Geneva, Switzerland.

The State Climatologist, (1985): *Publication of the American Association of State Climatologists: Height and Exposure Standards, for Sensors on Automated Weather Stations*, vol. 9, No. 4.

EPA, (1989): *Quality Assurance Handbook for Air Pollution Measurement Systems*, EPA Office of Research and Development, Research Triangle Park, North Carolina 27711.

8. RAWS Orientation

8.1 Determining True North and Sensor Orientation

Orientation of the wind direction sensor is done after the datalogger has been programmed and the location of True North has been determined. True North is usually found by reading a magnetic compass and applying the site-specific correction for magnetic declination; where the magnetic declination is the number of degrees between True North and Magnetic North. Magnetic declination for a specific site can be obtained from a USGS map, local airport, or through the web calculator offered by the USGS (Section 8.2, *USGS Web Calculator*). A general map showing magnetic declination for the contiguous United States is shown in FIGURE 8-1.

Declination angles are always subtracted from the compass reading to find True North. A declination angle east of True North is reported as positive a value and is subtracted from 360 (0) degrees to find True North as shown FIGURE 8-2. A declination angle west of True North is reported as a negative value and is also subtracted from 0 (360) degrees to find True North as shown in FIGURE 8-3. Note that when a negative number is subtracted from a positive number, the resulting arithmetic operation is addition.

For example, the declination for Longmont, CO is 10.1° , thus True North is $360^\circ - 10.1^\circ$, or 349.9° as read on a compass. Likewise, the declination for Mc Henry, IL is -2.6° , and True North is $0^\circ - (-2.6^\circ)$, or 2.6° as read on a compass.

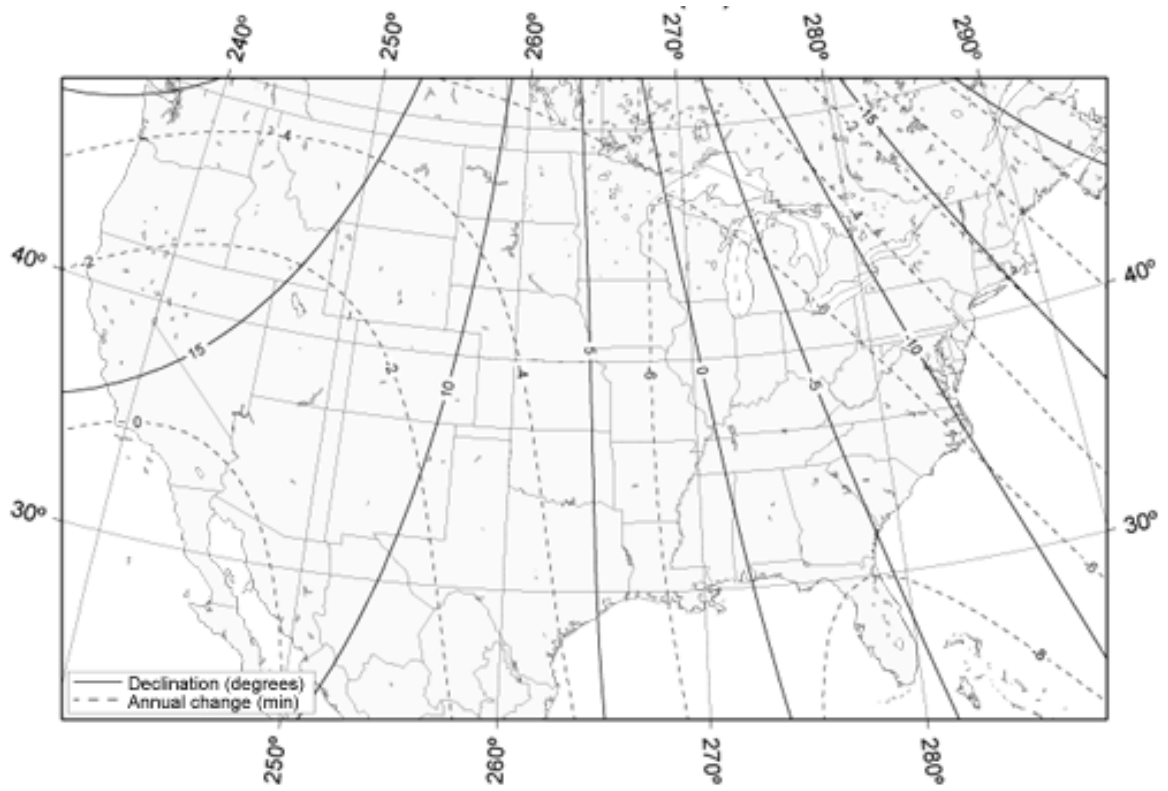

FIGURE 8-1. Magnetic declination for the contiguous United States

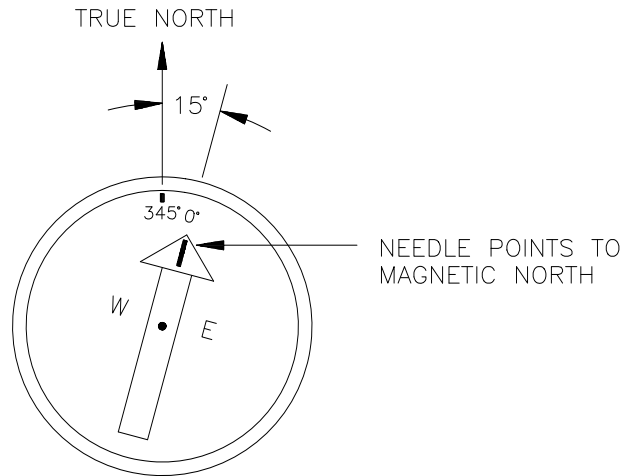

FIGURE 8-2. A declination angle east of True North (positive) is subtracted from 360 (0) degrees to find True North

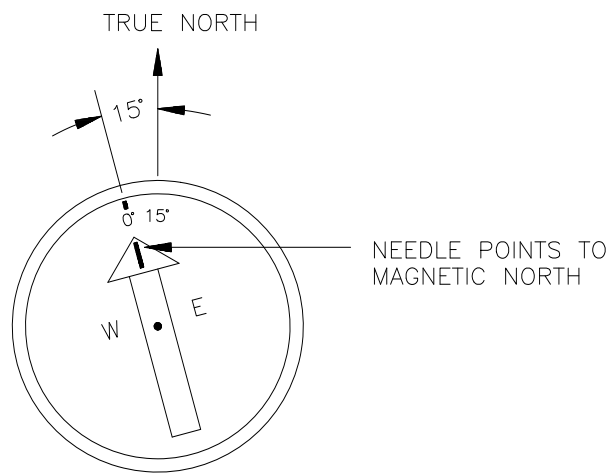

FIGURE 8-3. A declination angle west of True North (negative) is subtracted from 0 (360) degrees to find True North

8.2 USGS Web Calculator

The USGS provides an easy way of determining the declination of a specific site. Since magnetic declination fluctuates with time, it should be adjusted each time the wind sensor orientation is adjusted. The calculator can be accessed at: www.ngdc.noaa.gov/geomagmodels/Declination.jsp. FIGURE 8-4 shows an example for Logan, UT.

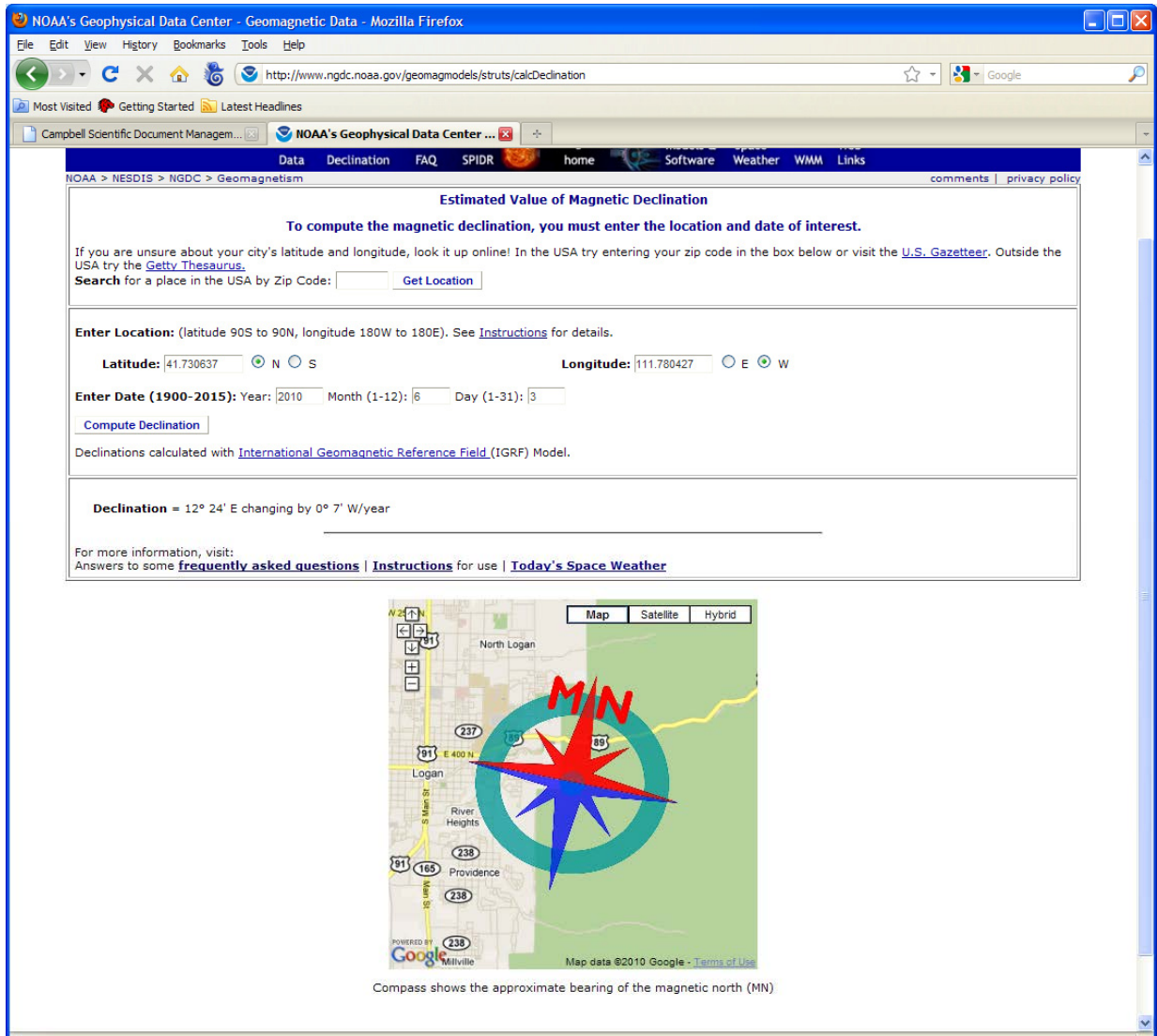
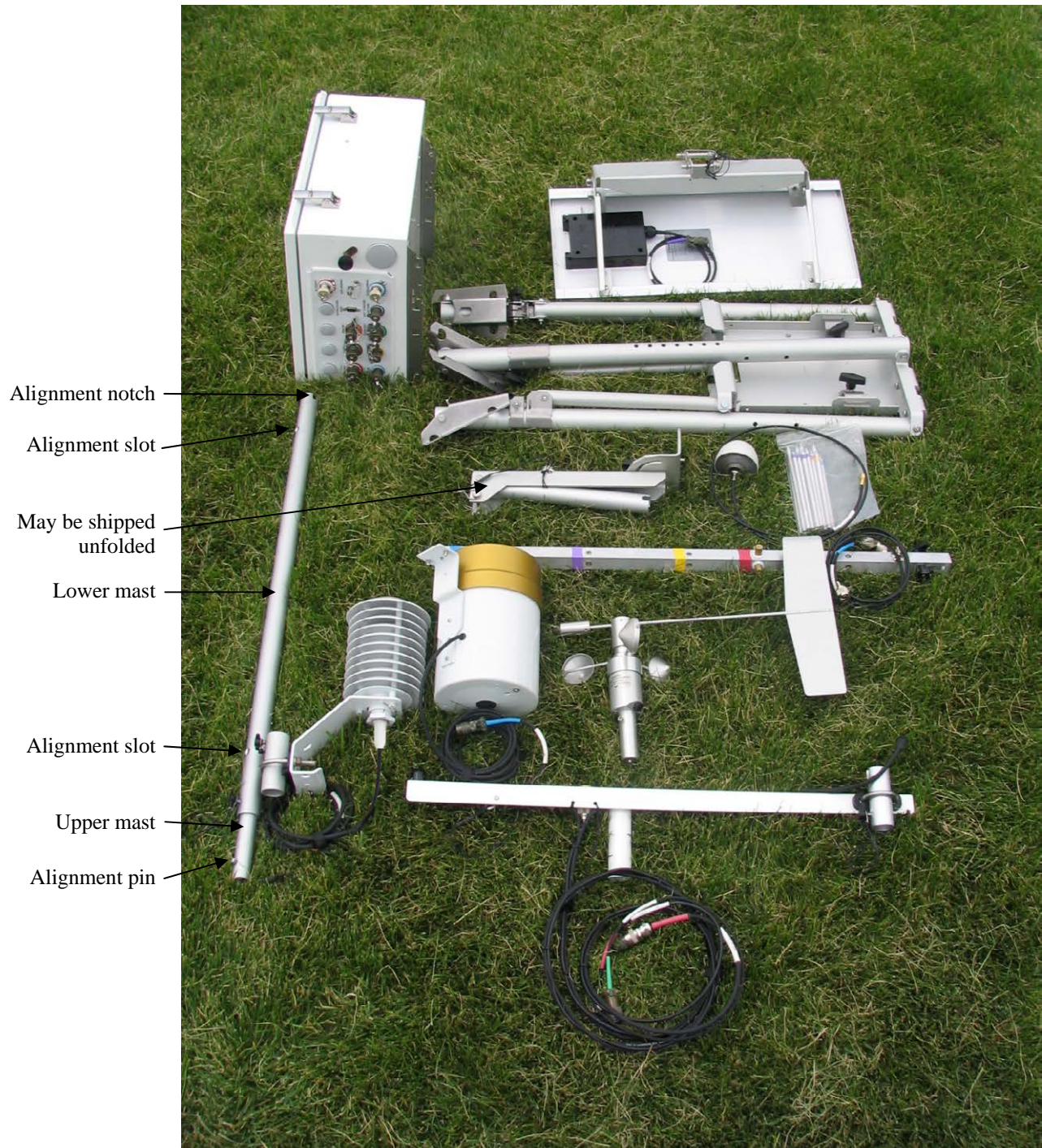
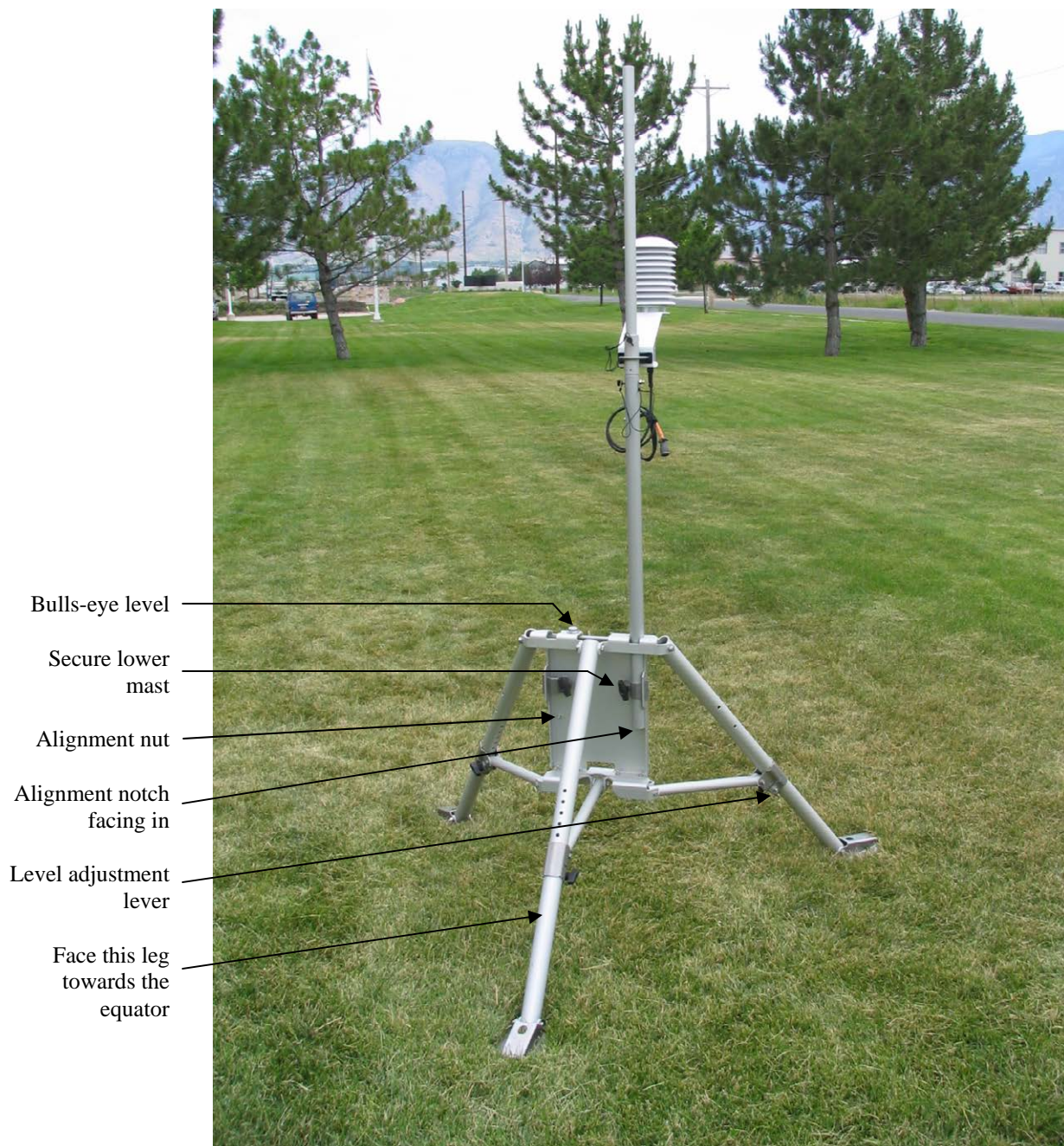

FIGURE 8-4. USGS web calculator

In the example above the declination for Logan, UT is 12° 24' or 12.4°. As shown in FIGURE 8-4, the declination for Utah is east (positive), so True North for this site is $360 - 12.4 = 347.6$ degrees. The annual change is 7 minutes west per year or -7 minutes/year.

Appendix A. Assemble the RAWS-F Station





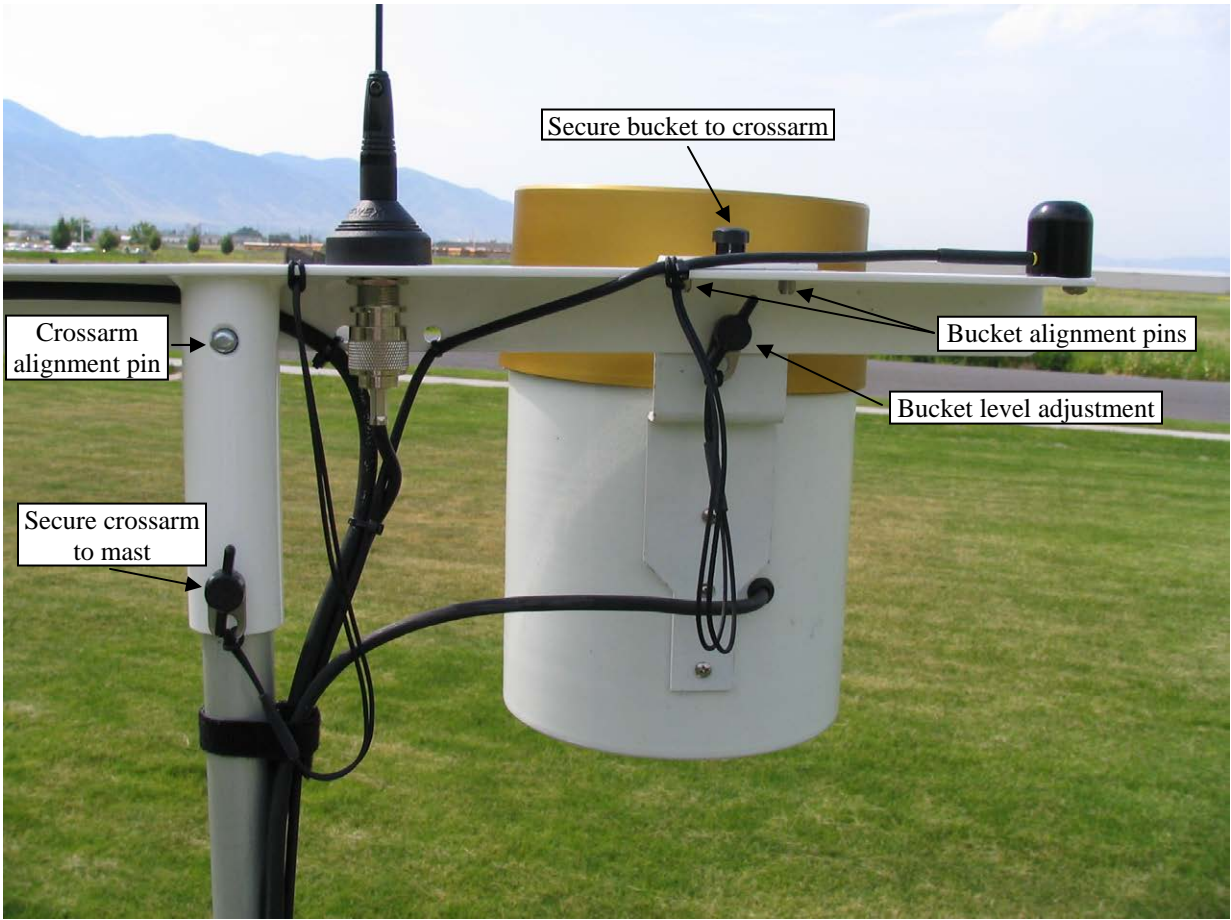

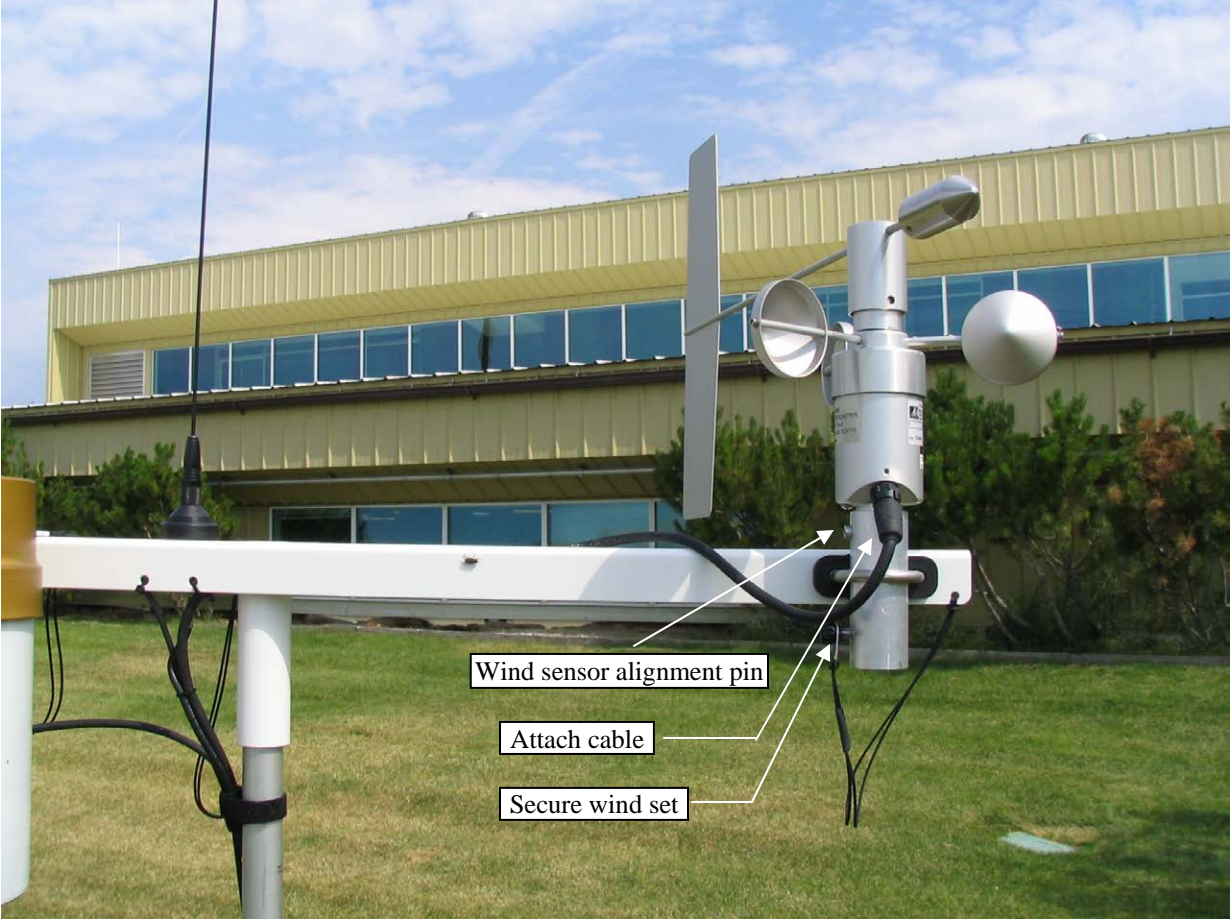

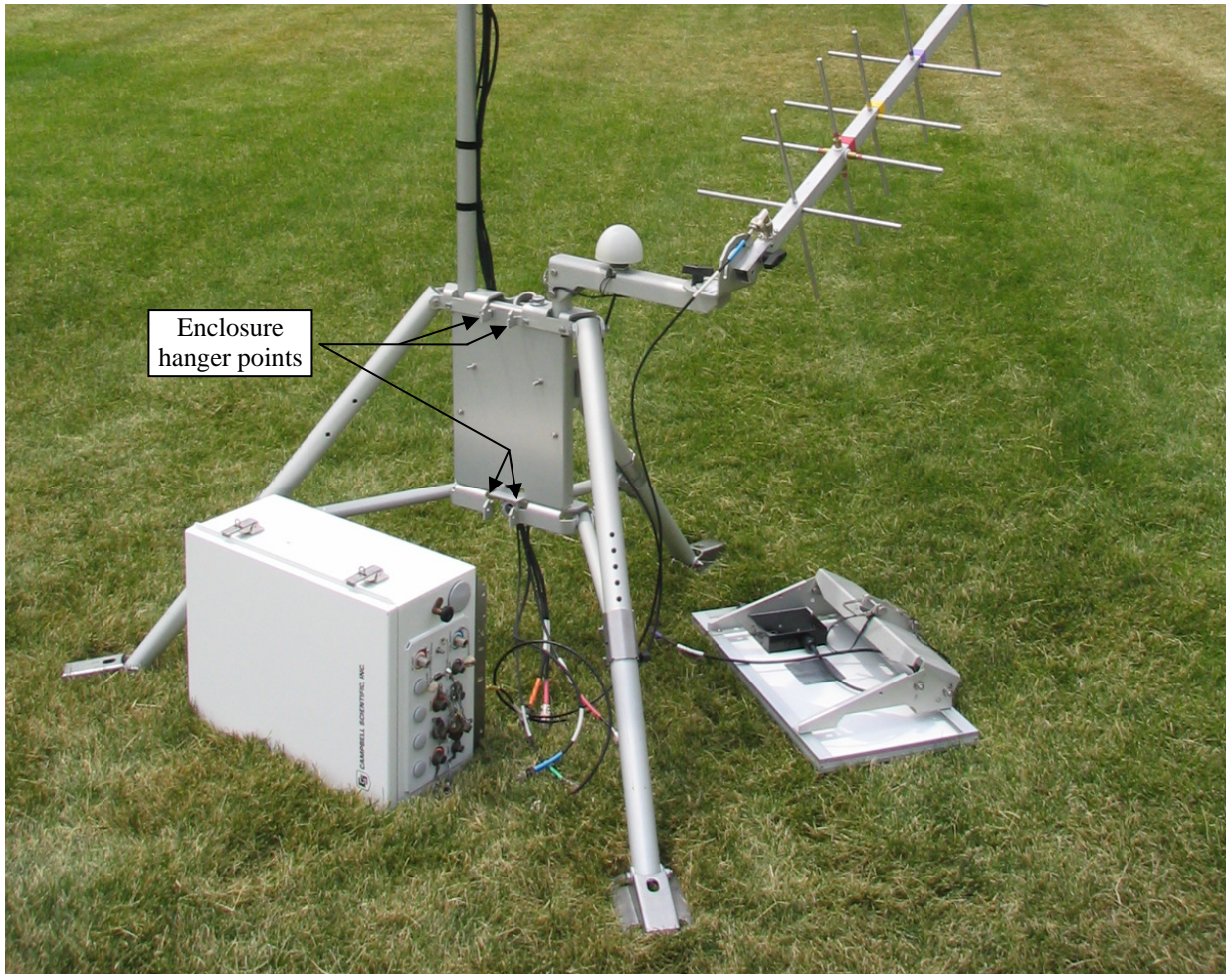



Solar panel should face the equator.





Optional transport cases

Wind sensor alignment tool

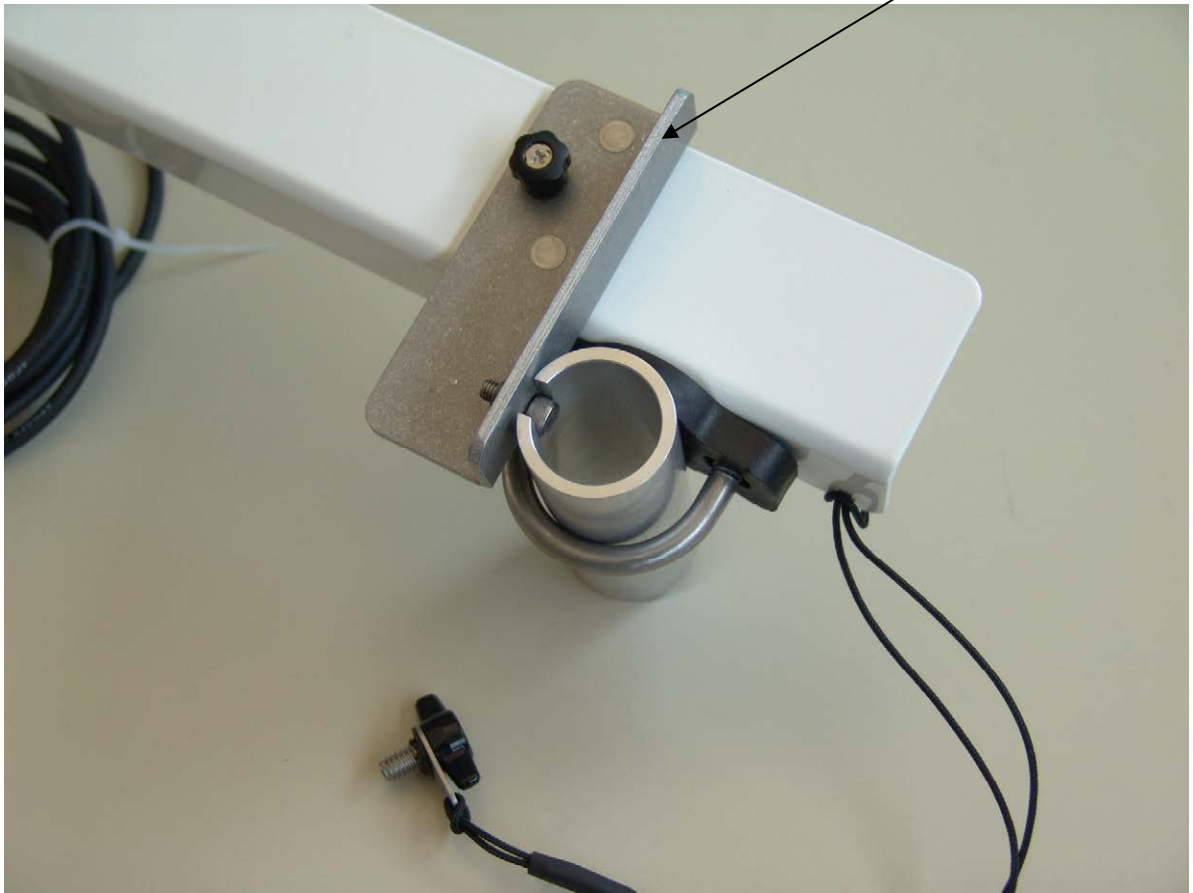

Appendix B. Transport Cases (Optional)



Hard transport case (optional)

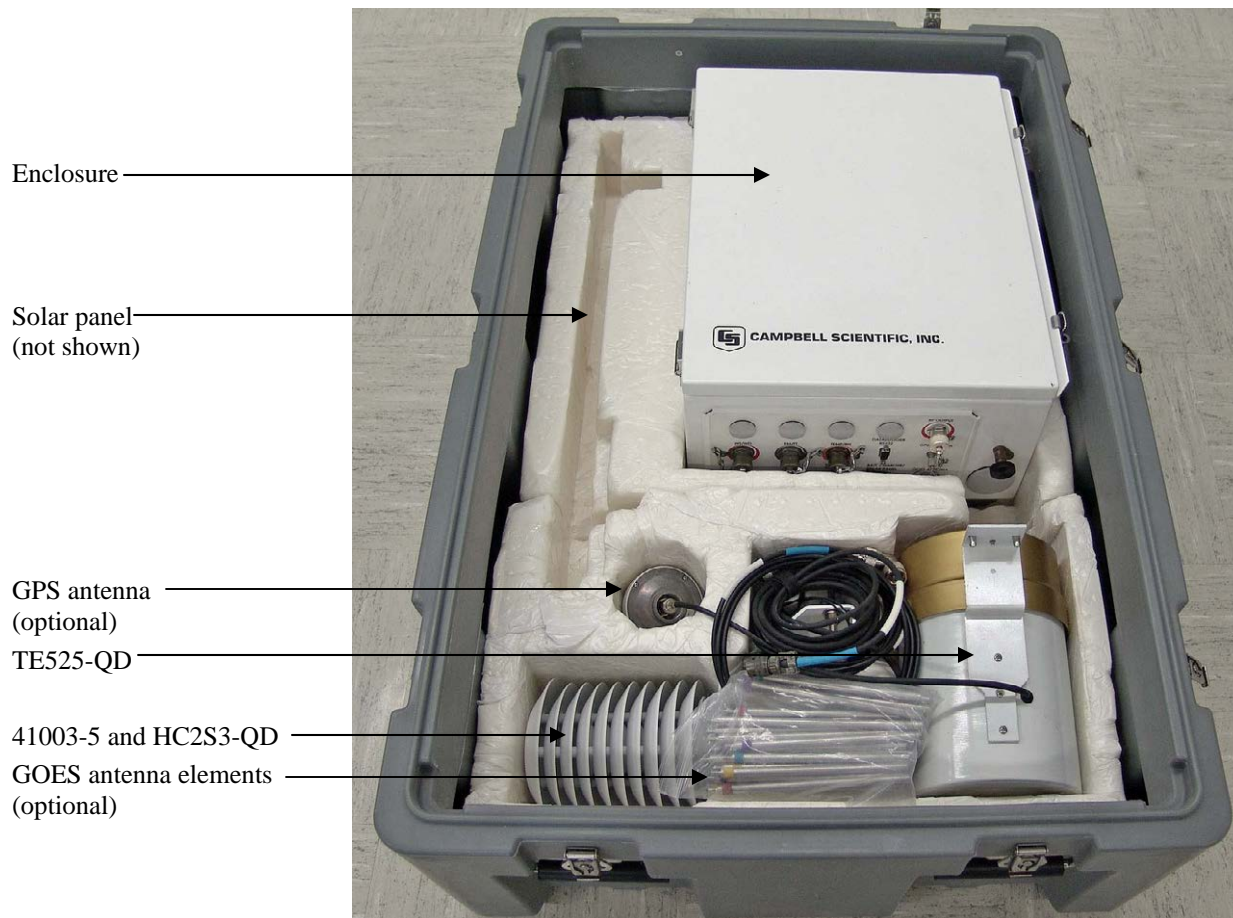

Hard transport case “base” layer (1 of 2)
Note: optional components also shown

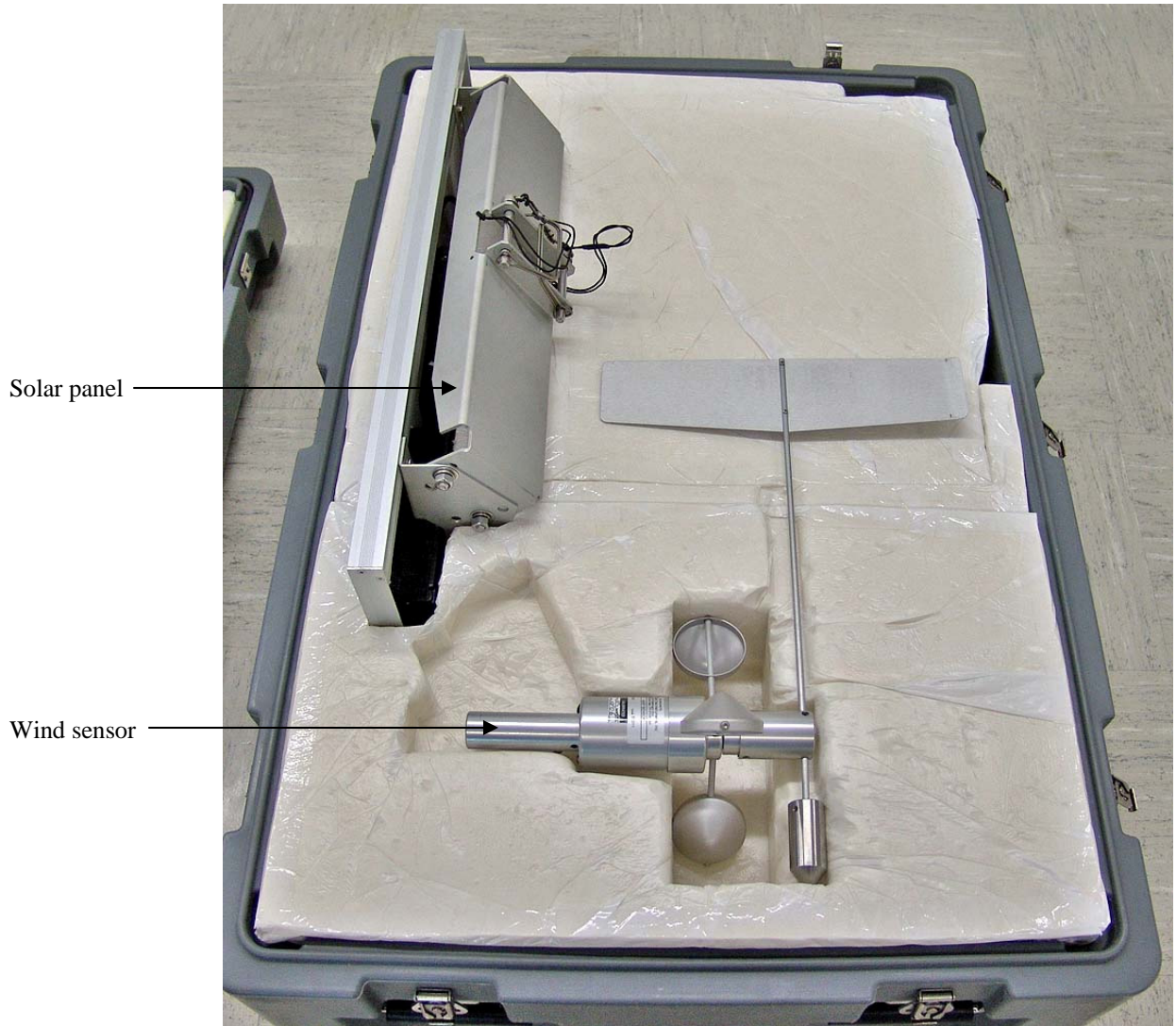

Hard transport case "base" layer (2 of 2)

Tripod crossarm

GOES antenna
(optional)



Hard transport case "lid" (1 of 1)
Note: optional components also shown



Canvas transport case (optional)



Canvas transport case
Note: optional components also shown

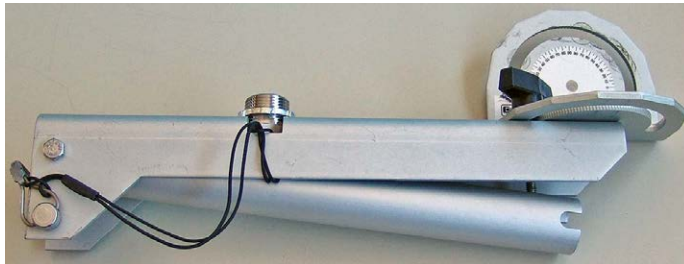

GOES and GPS mounting arm (optional)



Grounding assembly and tripod stake

Campbell Scientific Companies

Campbell Scientific, Inc. (CSI)

815 West 1800 North
Logan, Utah 84321
UNITED STATES

www.campbellsci.com • info@campbellsci.com

Campbell Scientific Africa Pty. Ltd. (CSAf)

PO Box 2450
Somerset West 7129
SOUTH AFRICA

www.csafrica.co.za • cleroux@csafrica.co.za

Campbell Scientific Australia Pty. Ltd. (CSA)

PO Box 8108
Garbutt Post Shop QLD 4814
AUSTRALIA

www.campbellsci.com.au • info@campbellsci.com.au

Campbell Scientific do Brasil Ltda. (CSB)

Rua Apinagés, nbr. 2018 – Perdizes
CEP: 01258-00 – São Paulo – SP
BRASIL

www.campbellsci.com.br • vendas@campbellsci.com.br

Campbell Scientific Canada Corp. (CSC)

14532 – 131 Avenue NW
Edmonton AB T5L 4X4
CANADA

www.campbellsci.ca • dataloggers@campbellsci.ca

Campbell Scientific Centro Caribe S.A. (CSCC)

300 N Cementerio, Edificio Breller
Santo Domingo, Heredia 40305
COSTA RICA

www.campbellsci.cc • info@campbellsci.cc

Campbell Scientific Ltd. (CSL)

Campbell Park
80 Hathern Road
Shepshed, Loughborough LE12 9GX
UNITED KINGDOM

www.campbellsci.co.uk • sales@campbellsci.co.uk

Campbell Scientific Ltd. (CSL France)

3 Avenue de la Division Leclerc
92160 ANTONY
FRANCE

www.campbellsci.fr • info@campbellsci.fr

Campbell Scientific Ltd. (CSL Germany)

Fahrenheitstraße 13
28359 Bremen
GERMANY

www.campbellsci.de • info@campbellsci.de

Campbell Scientific Spain, S. L. (CSL Spain)

Avda. Pompeu Fabra 7-9, local 1
08024 Barcelona
SPAIN

www.campbellsci.es • info@campbellsci.es