



# Mass Spectrometers for Surface Analysis

# MASS SPECTROMETERS

## for Surface Analysis

Hiden Analytical have been designing and developing the highest quality quadrupole mass spectrometer based systems for over 40 years. We have built a reputation for delivering instruments with superior sensitivity, accuracy and reproducibility together with a first class global service and applications support network.

Hiden surface analysis products are available as complete systems, sub-assemblies and individual components. The products combine high performance and ease of use with unparalleled flexibility. Hiden can provide customisation for specific research needs or process monitoring requirements, ensuring optimised performance tailored to your application.

The range of ion guns and spectrometers provides for static SIMS (secondary ion mass spectrometry), depth profiling SIMS and SNMS (sputtered neutral mass spectrometry) as well as offering mass and energy resolved detection for low energy ISS (ion scattering spectroscopy).



# Contents

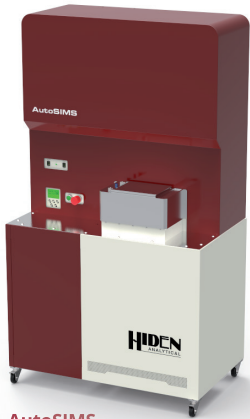

AutoSIMS

## SIMS INSTRUMENTS

---

### INTEGRATED SIMS SYSTEMS

- ▶ **Compact SIMS** – A Design Breakthrough in Surface Analysis
  - ▶ **AutoSIMS** – Automatic Surface Analysis System
- 

### SIMS WORKSTATION SERIES – UHV Surface Analysis for Thin Film Depth Profiling

- ▶ **FOUNDATION SIMS WORKSTATION**
  - ▶ **SIMS WORKSTATION**
  - ▶ **SIMS WORKSTATION<sup>PLUS</sup>**
- 

### CUSTOM SIMS SOLUTIONS

---

### ToF-qSIMS WORKSTATION – Innovative Time of Flight Quadrupole SIMS System

---



ToF-qSIMS Workstation

## SIMS COMPONENTS

---

**EQS** – SIMS Detector

---

**MAXIM** – SIMS/SNMS Detector

---

**PRIMARY ION SOURCES** – Optimised for Surface Analysis

- ▶ **IG20** – A 5 keV Caesium Ion Gun
  - ▶ **IG5C** – A 5 keV Argon or Oxygen Ion Gun
- 

**SOFTWARE** – Control for SIMS

---

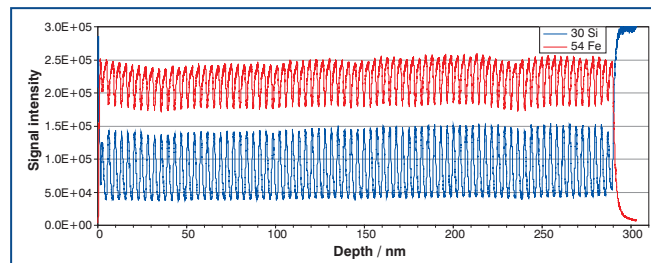

High depth resolution 1.8 nm layers

# SIMS WORKSTATION SERIES

## UHV Surface Analysis for Thin Film Depth Profiling

The **SIMS Workstation** is a family of instruments based around a large multi-function UHV chamber. The instrument is designed to be flexible, both in terms of function and cost, so features can be added or upgrades made as required. However, as a guide there are three standard configurations:

▶ **Foundation SIMS Workstation**

▶ **SIMS Workstation**

▶ **SIMS Workstation<sup>Plus</sup>**

The **Foundation SIMS Workstation** has the main chamber and IG20 argon/oxygen source together with the 9 mm MAXIM spectrometer, a simple manipulator and an electron gun for charge compensation. This can be expanded with the addition of a full X-Y manipulator and load lock to create the standard **SIMS Workstation**. The **SIMS Workstation<sup>Plus</sup>** is the fully featured instrument with the IG5C caesium ion gun, liquid nitrogen cold trap and oxygen flood. It is, of course, possible to specify other options on all of the instruments.

The Workstation chamber is specifically designed to allow access through the top port for an XPS spectrometer and a port on the front of the chamber is optimised for a non-monochromated x-ray source.



**SIMS Workstation<sup>Plus</sup>**

# Compact SIMS & AutoSIMS

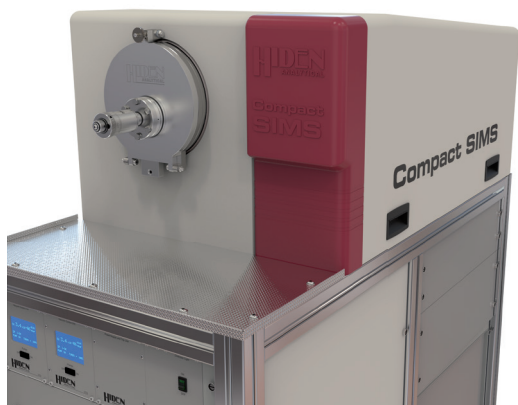

Compact SIMS

## Compact SIMS

A Design Breakthrough in Surface Analysis

The Hiden Compact SIMS tool is designed for fast and reliable characterisation of layer structures, surface contamination and impurities with sensitive detection of positive ions being assisted by the oxygen primary ion beam and provides isotopic sensitivity across the entire periodic table. The ion gun geometry is chosen to provide nanometre depth resolution and near surface analysis. The instrument is self-contained requiring only a standard electrical outlet for operation.

### FEATURES:

- ▶ Oxygen IG20 primary Ion Gun and 6 mm MAXIM spectrometer with positive ion detection
- ▶ Manual rotary stage for high reliability and ease of use
- ▶ Self-contained system (requires single phase 2 kW power supply)
- ▶ Static and dynamic SIMS with 3D imaging
- ▶ Optional electron gun and negative ion detection

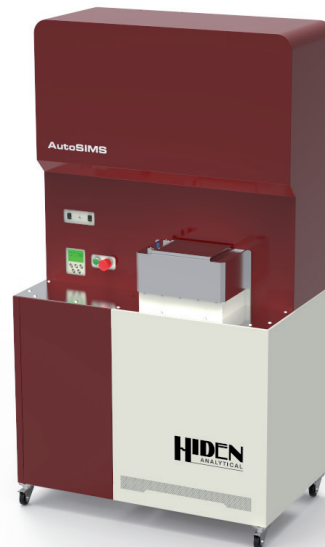

AutoSIMS

## AutoSIMS

Automatic Surface Analysis System

The AutoSIMS is built around the same source and analyser as the Compact SIMS but with the addition of a large sample holder and automated stage. This allows it to perform automated analysis batches, running 24/7 and potentially making hundreds of analyses per day. Of course, it can also be run in full manual mode where the precision of the stage and large sample area make it a very attractive instrument for the expert user.

### FEATURES:

- ▶ Fully automated, unattended, SIMS analysis
- ▶ Large X-Y stage (70 x 100 mm) with customisable loading cassette
- ▶ Oxygen primary ion gun for sensitive analysis
- ▶ Parameter entry by spreadsheet
- ▶ Modular servicing for high up-time
- ▶ Nanometre depth resolution
- ▶ Optional electron flood gun allows analysis of insulators

### APPLICATIONS:

- ▶ Thin film failure analysis / product verification
- ▶ Corrosion and tribology investigations
- ▶ Static and dynamic SIMS
- ▶ Large area investigations

# CUSTOM SIMS SOLUTIONS

The Hiden SIMS components are available separately to enable SIMS to be added to an existing tool or to other instrumentation. A particularly useful customisation is the Modular SIMS where an ion gun, spectrometer, electron gun and light/camera are mounted on a single DN150 or larger flange.

## Hi5 SIMS

Simultaneous Positive & Negative Ion Analysis

The Hi5 SIMS instrument, operates with a 40 nm oxygen plasma FIB ion gun, high precision five axis sample stage and Hiden's unique DLS-20 mass spectrometer capable of resolving mass peaks to 0.005 amu. The uniquely powerful tool is applied to aerospace, nuclear, medical and energy materials applications.

### FEATURES:

- ▶ Dual EQS detectors can be fitted to any suitable sputter analysis chamber
- ▶ Allows efficient use of secondary ions and halves analysis time
- ▶ Images and depth profiles are accurately registered

### APPLICATIONS:

- ▶ Energy materials – solar and fuel cells
- ▶ Metallurgy – corrosion and passivation
- ▶ Failure analysis – surface chemistry, defect identification, functional coatings

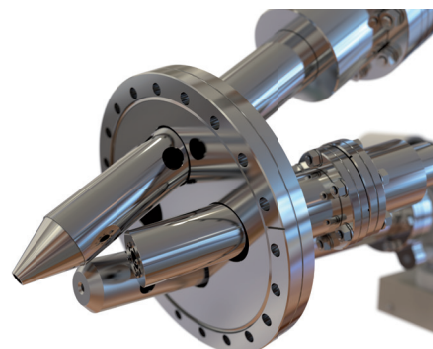

Modular SIMS

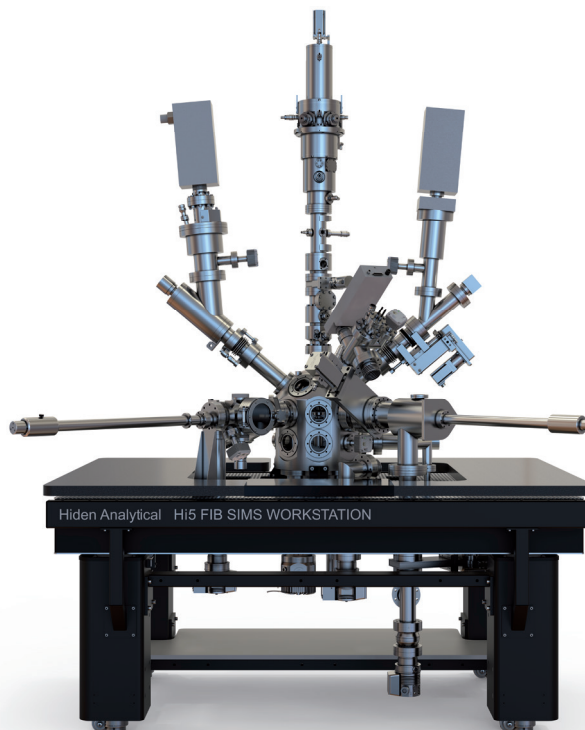

Hi5 SIMS Workstation

# ToF-qSIMS WORKSTATION

## Innovative Time of Flight Quadrupole SIMS System

The ToF-qSIMS Workstation system offers the comprehensive capabilities of static ToF-SIMS, and high dynamic range depth profiling from the quadrupole SIMS. The system is designed for surface analysis and depth profiling applications of a wide range of materials including polymers, pharmaceuticals, superconductors, semiconductors, alloys, optical and functional coatings and dielectrics, with measurement of trace components to sub-ppm levels.

Fully integrated and optimised for high performance SIMS analysis, the ToF-qSIMS Workstation system includes a multi-port UHV chamber, ToF-SIMS analyser, Hiden's MAXIM quadrupole SIMS analyser, IG20 gas primary ion gun, a Cs metal ion gun and a sample holder designed to accommodate the broadest sample range. High sensitivity SNMS mode is included for quantitative analysis of metallurgical thin films, conductive and non-conductive oxides and other alloy materials and coatings. Facilities for SIMS enhancement including oxygen flood, electron charge neutralization and vacuum bakeout are included as standard. The ToF-qSIMS capability enables hyperspectral imaging for spatially resolved detailed materials analysis.



ToF-qSIMS Workstation

### FEATURES:

- ▶ Fully integrated & optimised for high performance SIMS analysis
- ▶ Dual column qSIMS and ToF SIMS analysers
- ▶ qSIMS analyser for Dynamic SIMS, featuring high dynamic range depth profiling
- ▶ ToF-SIMS analyser for Static SIMS, enabling top monolayer specificity
- ▶ Hyperspectral imaging and depth profiling for rapid determination of spatial distributions
- ▶ Mass range 6 to 10 000 amu and 1500 FWHM resolution
- ▶ IG20 Primary Gas ion gun for enhanced secondary ion emissions for SIMS
- ▶ Hiden Cs metal ion gun for dynamic and static SIMS

### APPLICATIONS:

- ▶ Contamination and surface condition studies in semiconductor, adhesives, thin film coatings and pharmaceutical industries
- ▶ Failure analysis, where a coating or substrate has failed in service due to corrosion, mechanical failure or a manufacturing defect
- ▶ Reverse engineering of products where species are unknown
- ▶ Depth profiling for layer

# EQS

## SIMS Detector

The Hiden EQS is a high transmission quadruple secondary ion mass spectrometry, SIMS, detector including a 45 degree electrostatic sector for simultaneous ion energy analysis. Ions are collected on the axis of the device with a low potential screened extraction field which makes it very popular for fitting as an after-market detector to a wide variety of surface analysis instrumentation. The EQS has been fitted to focussed ion beam (FIB) microscopes and XPS tools.

The flight tube transfer lens system allows insertion lengths up to 750 mm to be achieved with high transmission and the system can be supplied with either 6 mm or 9 mm triple stage quadrupole mass filters. With over 6 orders of magnitude dynamic range the EQS is ideally matched to SIMS depth profiling and outputs are provided for direct connection to the IG20 and IG5C ion guns.

The EQS is available with a differential pumping option allowing operation at chamber pressures of up to  $1 \times 10^{-5}$  mbar which is suitable for use when oxygen flooding to enhance ion yield or to maintain planar surface topography.



EQS SIMS Spectrometer

### FEATURES:

- ▶ 45 degree energy analyser with resolution to 0.2 eV
- ▶ +ve and -ve secondary ion detection
- ▶ Optional differential pumping
- ▶ SNMS option
- ▶ Integrated residual gas analysis
- ▶ Standard and custom lengths to 750 mm insertion
- ▶ Mass range options of 50, 300, 510 and 1000 amu
- ▶ 6 mm or 9 mm triple quadrupole analyser
- ▶ Slim fitting for crowded sample regions
- ▶ Can be mounted on a 50 mm or 100 mm z-drive retraction system

### APPLICATIONS:

- ▶ Static and dynamic SIMS analysis
- ▶ FIB-SIMS
- ▶ Sputtered ion and neutral mass/energy analysis
- ▶ Routine materials science sputter depth profiling
- ▶ High performance "bolt-on" SIMS/SNMS

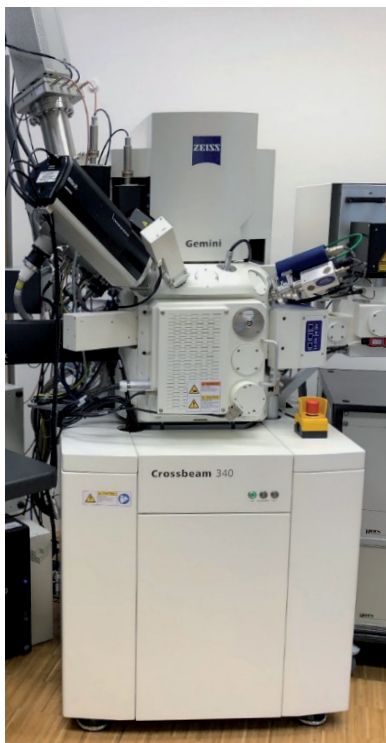

HIDEN EQS (top left) on Zeiss Crossbeam 340



# IG5C & IG20 ION GUNS

## A 5 KEV CAESIUM ION GUN

The IG5C is a self-contained caesium ion gun designed for dynamic and static SIMS applications. The high brightness miniature surface ionisation source uses a safe caesium salt to generate an intense beam which is focussed via a two lens column onto the target. Thermal management of the source is an integrated feature of the Ion Gun Controller software allowing unattended starting and stopping, including ioniser regeneration at shutdown. With a minimum spot size of under 30 µm it makes an excellent ion gun for imaging.

Caesium is a very useful ion source for general analysis and mixed materials where the CsM<sup>+</sup> mode can be used to great effect. Quantitative depth profiling with nanometre depth resolution of thin dielectrics and layers formed by deposition and corrosion is possible.

### FEATURES:

- ▶ 1 keV to 5 keV ion energy
- ▶ Spot size from < 30 µm to > 1 mm
- ▶ Current 1 pA to > 100 nA
- ▶ Easily changed, self-aligning ion source
- ▶ Two lens column
- ▶ Easily changed beam forming aperture
- ▶ Differentially pumped

### APPLICATIONS:

- ▶ SIMS depth profiling of electronegative elements
- ▶ SIMS depth profiling using the CsM<sup>+</sup> mode
- ▶ Efficient static SIMS analysis
- ▶ Quantitative analysis of oxides and nitrides



**IG5C** - A 5 keV Caesium ion gun for UHV surface analysis applications

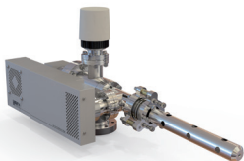

**IG20** - A 5 keV Argon or Oxygen ion gun for UHV surface analysis applications

## A 5 KEV ARGON OR OXYGEN ION GUN

The IG20 is an easy to use gas ion gun with an electron impact ion source ideal for SIMS, Auger and XPS applications. Whilst most frequently used with oxygen (to enhance secondary ion emission for SIMS) the IG20 will produce beams of many gases, including all noble gases and even hydrogen. The gun features two independent, switchable, filaments so that analysis can continue even when one filament reaches the end of its life, typically in excess of 500 hours – replacement can then be made at the user's convenience.

The ion gun will produce beams from 1 keV to 5 keV with a spot size of under 100 µm at higher energy. An optional large lens ion source is available for high dynamic range work and this can also be fitted with noble metal parts for enhanced beam cleanliness.

The low gas usage of the source means that the gun can be run from small laboratory bottles (supply the gas at 0.3 bar) and a manifold can be supplied to quickly clean and purge gas lines for rapid changes in the ion species.

The gun uses the Hiden Ion Gun Controller software that stores and retrieves previous settings, provides timed start and stop features and can internally generate rasters and lines for use in stand-alone applications.

### FEATURES:

- ▶ 1 keV to 5 keV ion energy
- ▶ 10 pA to 600 nA beam current
- ▶ < 100 µm to > 1 mm spot size
- ▶ Twin filament, long life, electron impact ion source
- ▶ Reliable and easy control using Hiden IGC software
- ▶ Differential pumping to reduce chamber load

### APPLICATIONS:

- ▶ SIMS, dynamic and static (using O<sub>2</sub>, Ar and Xe)
- ▶ Sample cleaning and depth profiling for XPS and Auger
- ▶ Fundamental studies of ion-solid interaction
- ▶ Local area milling and surface modification

# MAXIM

## SIMS/SNMS Detector

The MAXIM SIMS spectrometer provides high transmission in a compact unit designed specifically for routine materials analysis. A parallel plate energy filter is used to reject high energy ions that would affect mass resolution whilst permitting a wide bandwidth of optimally filtered ions to enter the triple filter quadrupole analyser – which can be either 6 or 9 mm pole diameter. The MAXIM extracts ions from 30 degrees below its inlet aperture thus it is mounted “off axis” which can be useful to free space beneath the sample. An electron impact ioniser is positioned at the front of the MAXIM, subtending the largest solid angle available, to permit analysis of sputtered neutral atoms. Sputtered neutral mass spectrometry (SNMS) is more quantitative than SIMS in regions of matrix variation and is a valuable tool in high concentration analysis, especially of metal alloys. The MAXIM provides excellent imaging over a large area and reproducible quantification – an important factor in a production environment.

The exceptionally low screened extraction field (3V/mm) reduces perturbation of low energy primary ion beams and also allows easier electron beam charge compensation.

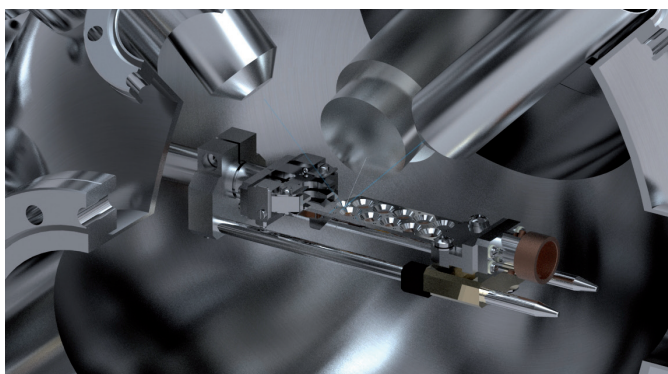

MAXIM SIMS/SNMS Spectrometer

### FEATURES:

- ▶ 30 degree collection angle
- ▶ +ve, -ve and neutral detection
- ▶ Integral energy filter
- ▶ Electron impact ioniser
- ▶ Mass range options of 50, 300, 510 and 1000 amu
- ▶ Wide field of view – 6 x 6 mm
- ▶ Low extraction field

### APPLICATIONS:

- ▶ Static and dynamic SIMS
- ▶ Sputtered neutral mass spectrometry (SNMS)
- ▶ Materials analysis
- ▶ Routine SIMS for production control
- ▶ Integration into compact, dedicated, instruments

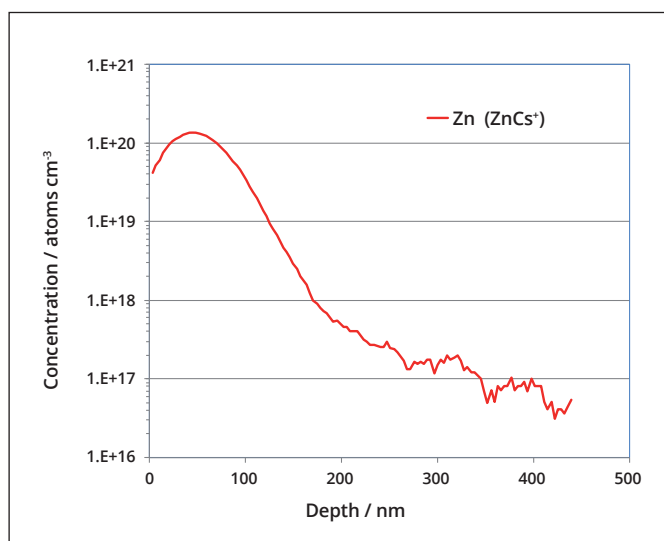

Depth profile of Zinc in GaAs using CSM\*

# SOFTWARE

## Control for SIMS

All SIMS spectrometers can be run using the standard Hiden MASSoft software suite. This permits auto-tuning of the secondary column as well as collection of mass spectral, depth profile and diagnostic data.

The **SIMS Mapper** software is an image based dedicated SIMS analysis tool. Depth profiles are collected as a stack of images from which local depth profiles and 3D reconstructions can be made after acquisition. By allowing gating after data acquisition, it is possible to maximise dynamic range and to choose to include or exclude specific features as well as to take multiple depth profiles from a single data set or to re-evaluate a data set in the future. Standard and custom export formats are available to enable the use of third party applications for image and data processing.

### FEATURES:

- ▶ Easy choice of species directly from periodic table
- ▶ Integrated mass interference calculator
- ▶ Interactive image and depth profile gate control
- ▶ Stored templates for repeat and automated analysis
- ▶ Multiple export options (custom options available)
- ▶ 3D data view for easy interpretation
- ▶ Local mass spectrum tool for feature identification

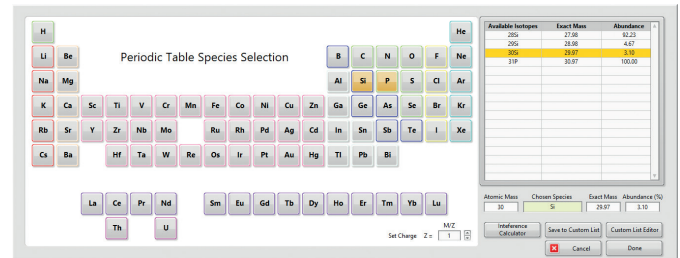

SIMS Mapper species choice

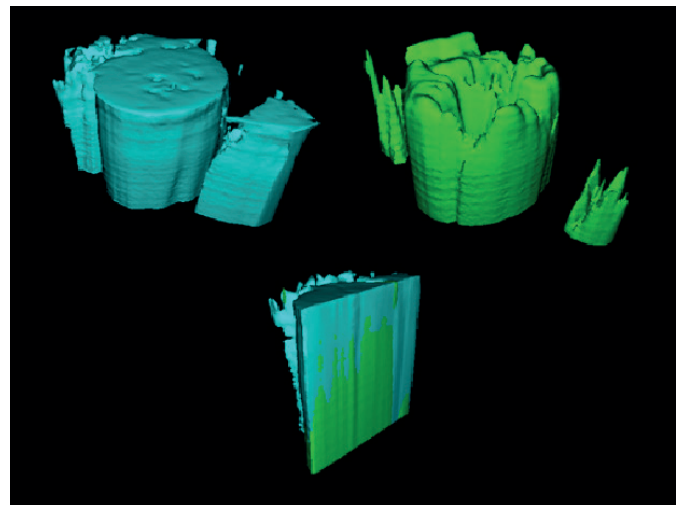

3D reconstruction showing carbon (blue) contamination of a gold (green) 1 mm diameter electrical contact

The **Ion Gun Controller** software allows tuning and measurement of the primary ion beam. Gun parameters may be stored and recalled for rapid operation and the beam profile can be observed in systems fitted with a Faraday cup. Tools are included for initial beam set-up (Beam Finder) and for correct source procedures such as thermal management of the caesium ion source.

### FEATURES:

- ▶ Save and recall of ion gun parameters
- ▶ Integrated Faraday cup bias power supply and electrometers
- ▶ Clearly visible always-on diagnostics
- ▶ Ion source management tool set
- ▶ Ability to be controlled from external programs for high level of integration

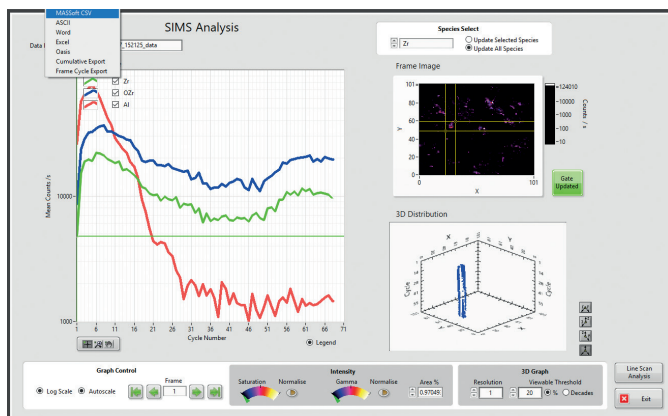

SIMS Mapper acquisition window

# HiddenAPPLICATIONS

Hidden's quadrupole mass spectrometer systems address a broad application range in:

## GAS ANALYSIS

- ▶ dynamic measurement of reaction gas streams
- ▶ catalysis and thermal analysis
- ▶ molecular beam studies
- ▶ dissolved species probes
- ▶ fermentation, environmental and ecological studies



## SURFACE ANALYSIS

- ▶ UHV TPD
- ▶ ToF qSIMS and SIMS analysers
- ▶ end point detection in ion beam etch
- ▶ elemental imaging – 3D mapping



## PLASMA DIAGNOSTICS

- ▶ plasma source characterisation
- ▶ etch and deposition process reaction kinetic studies
- ▶ analysis of neutral and radical species

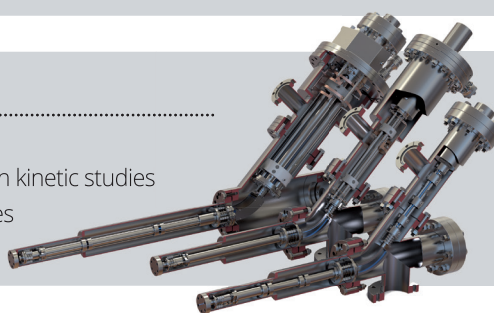

## VACUUM ANALYSIS

- ▶ partial pressure measurement and control of process gases
- ▶ reactive sputter process control
- ▶ vacuum diagnostics
- ▶ vacuum coating process monitoring



# HIDDEN

ANALYTICAL

Hidden Analytical Ltd.  
420 Europa Boulevard  
Warrington WA5 7UN England

**T** +44 [0] 1925 445 225

**F** +44 [0] 1925 416 518

**E** [info@hidden.co.uk](mailto:info@hidden.co.uk)

**W** [www.HiddenAnalytical.com](http://www.HiddenAnalytical.com)



## Sales Offices:

We have sales offices situated around the globe. **Visit our website for further information.**