



TB4, TB4MM, CS700, and CS700H

Tipping Bucket Rain Gages



Please read first

About this manual

Please note that this manual was produced by Campbell Scientific Inc. primarily for the North American market. Some spellings, weights and measures may reflect this. In addition, while most of the information in the manual is correct for all countries, certain information is specific to the North American market and so may not be applicable to European users. Differences include the U.S. standard external power supply details where some information (for example the AC transformer input voltage) will not be applicable for British/European use. Please note, however, *that when a power supply adapter is ordered from Campbell Scientific it will be suitable for use in your country.*

Reference to some radio transmitters, digital cell phones and aerials (antennas) may also not be applicable according to your locality. Some brackets, shields and enclosure options, including wiring, are not sold as standard items in the European market; in some cases alternatives are offered.

Recycling information for countries subject to WEEE regulations 2012/19/EU



At the end of this product's life it should not be put in commercial or domestic refuse but sent for recycling. Any batteries contained within the product or used during the products life should be removed from the product and also be sent to an appropriate recycling facility, per [The Waste Electrical and Electronic Equipment \(WEEE\) Regulations 2012/19/EU](#). Campbell Scientific can advise on the recycling of the equipment and in some cases arrange collection and the correct disposal of it, although charges may apply for some items or territories. For further support, please contact Campbell Scientific, or your local agent.

Table of contents

1. Introduction	1
2. Precautions	1
3. Initial inspection	2
4. QuickStart	2
5. Overview	5
5.1 Wind screen	6
6. Specifications	7
6.1 Heated rain gage	8
7. Installation	8
7.1 Wiring	9
7.1.1 TB4, TB4M, or CS700 connections	9
7.1.2 CS700H heated rain gage connections	9
7.2 Data logger programming	11
7.2.1 PulseCount() instruction	12
7.2.2 SDI12Recorder() instruction	12
7.3 Siting	12
7.4 Mounting	13
7.4.1 Mounting to the CM240 and leveling	14
7.5 CS700H power supply installation	16
8. Operation	16
8.1 Sensor schematic	16
8.2 Long cable lengths	16
8.3 CS700H heated rain gage operation	17
8.3.1 SDI-12 measurement commands	18
8.3.2 CS700H extended commands	19
9. Troubleshooting and maintenance	21
9.1 Troubleshooting	21
9.2 Maintenance	21

9.2.1 Dismantling for cleaning	22
9.2.2 Reassembling the rain bucket	25
9.3 Calibration check	26
Appendix A. Importing Short Cut code into CRBasic Editor	28
Appendix B. Example programs	29
B.1 TB4 or CS700 example programs	29
B.1.1 CR6 program for the TB4 or CS700	29
B.1.2 CR1000X programs for the TB4 or CS700	30
B.2 CS700H example programs	32
B.2.1 CR6 program for the CS700H	32
B.2.2 CR1000X programs for CS700H	34
Appendix C. CS700H operation details	37
C.1 High power operation	40
C.2 External control	40
C.3 Status LED	41
C.4 Snow sensor	41
C.5 Operating modes	42
C.6 SDI-12 sensor support	44
C.6.1 Introduction	44
C.6.2 SDI-12 command basics	45
C.6.2.1 Acknowledge active command (a!)	46
C.6.2.2 Send identification command (aI!)	46
C.6.2.3 Start verification command (aV!)	46
C.6.2.4 Address query command (?!)	47
C.6.2.5 Change address command (aAb!)	47
C.6.2.6 Start measurement commands (aM!)	47
C.6.2.7 Start concurrent measurement commands (aC!)	48
C.6.2.8 Start measurement commands with cyclic redundancy check (aMC! and aCC!)	49
C.6.2.9 Stopping a measurement command	50
C.6.2.10 Send data command (aD0! ... aD9!)	50
C.6.2.11 Continuous measurement command (aR0! ... aR9!)	51
C.6.2.12 Extended commands	51
C.6.3 SDI-12 transparent mode	51
C.6.3.1 Changing an SDI-12 address	52

C.6.4 References	54
Appendix D. Phoenix Contact power supply specifications	55

1. Introduction

The TB4, TB4MM, CS700, and CS700H are tipping bucket rain gages that funnel rain into a mechanism that tips when filled. The TB4, CS700, and CS700H measure in 0.01-inch increments and the TB4MM measures in 0.2 mm increments. The TB4 and TB4MM have a lightweight plastic base, and the CS700 and CS700H have a heavy-duty, cast-aluminum base (Figure 1-1 [p. 1]). The CS700H is a heated rain gage for measuring the water content of snow.



*Figure 1-1. TB4 or TB4MM (left), CS700 (center), and CS700H (right)
Tipping Bucket Rain Gages*

NOTE:

This manual provides information only for CRBasic data loggers. For retired Edlog data logger support, see an older manual at www.campbellsci.com/old-manuals .

2. Precautions

- READ AND UNDERSTAND the [Safety](#) section at the back of this manual.
- The rain gages are precision instruments. Please handle them with care.



- Before using the rain gage, remove the rubber band and cardboard that secures the tipping bucket assembly during shipping.
- The black outer jacket of the cable is Santoprene® rubber. This compound was chosen for its resistance to temperature extremes, moisture, and UV degradation. However, this jacket will support combustion in air. It is rated as slow burning when tested according to U.L. 94 H.B. and will pass FMVSS302. Local fire codes may preclude its use inside buildings.
- While assembling the CS700H, ensure that the coiled cable and the neoprene jacket do not interfere with the tipping bucket mechanism when placing the funnel on the base.

3. Initial inspection

- Upon receipt of the TB4, TB4MM, CS700, and CS700H, inspect the packaging and contents for damage. File damage claims with the shipping company. Immediately check package contents against the shipping documentation. Contact Campbell Scientific about any discrepancies.
- The model number and cable length are printed on a label at the connection end of the cable. Check this information against the shipping documents to ensure the expected product and cable length were received.

4. QuickStart

A video that describes data logger programming using *Short Cut* is available at:

www.campbellsci.com/videos/cr1000x-data-logger-getting-started-program-part-3 . *Short Cut* is an easy way to program your data logger to measure the sensor and assign data logger wiring terminals. *Short Cut* is available as a download on www.campbellsci.com . It is included in installations of *LoggerNet*, *RTDAQ*, and *PC400*.

The following procedure also describes programming with Short Cut.

1. Open *Short Cut* and click **Create New Program**.
2. Double-click the data logger model.

- In the **Available Sensors and Devices** box, type TB4 or CS700. You can also locate the sensor in the **Sensors > Meteorological > Precipitation** folder. Double-click **TB4/TB4MM** or **CS700 Rain Gauge**. The units default to millimeters, which can be changed by clicking the **Rain** box and selecting one of the other options. The default rainfall per tip value of 0.01 inches should be used if the sensor is a TB4 or CS700 purchased at Campbell Scientific (U.S. office). Select 0.2 mm if the sensor is a TB4MM purchased at Campbell Scientific (U.S. office) or a TB4 or CS700 purchase at Campbell Scientific Canada.

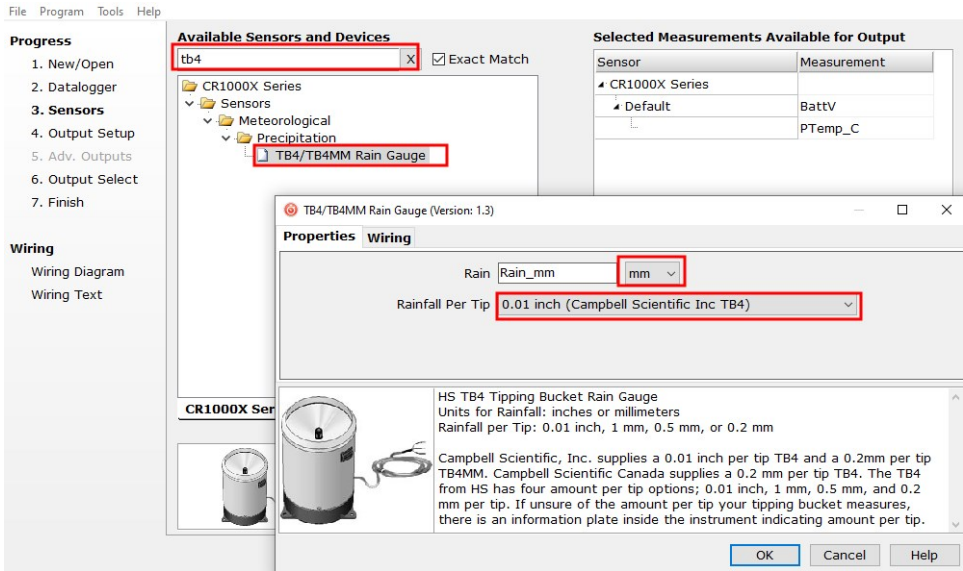

- Click on the **Wiring** tab to see how the sensor is to be wired to the data logger. Click **OK** after wiring the sensor.

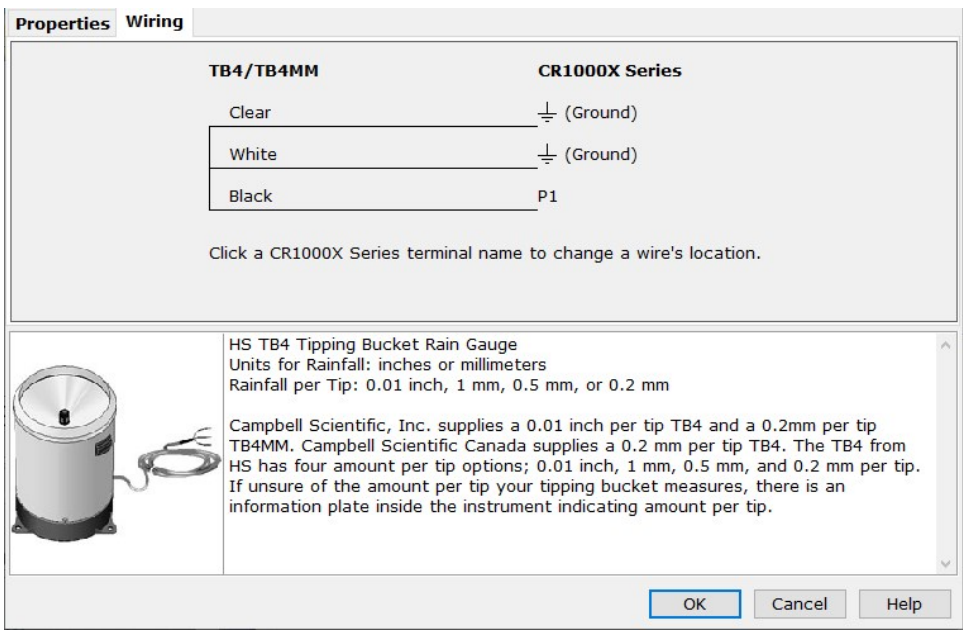

- Repeat steps three and four for other sensors. **Click Next.**
- In **Output Setup**, type the scan rate, meaningful table names, and the **Data Output Storage Interval**.

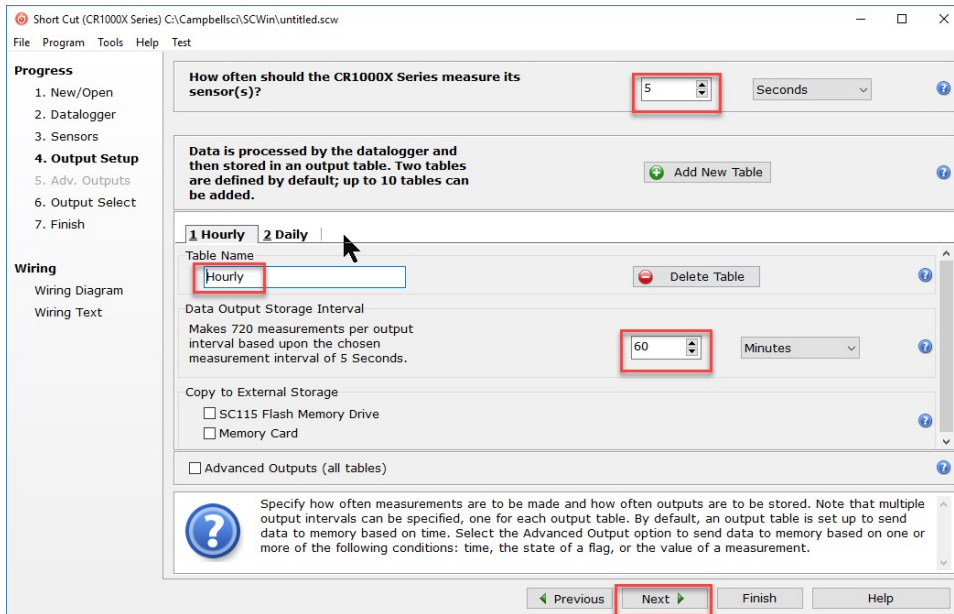

- Select the output options.

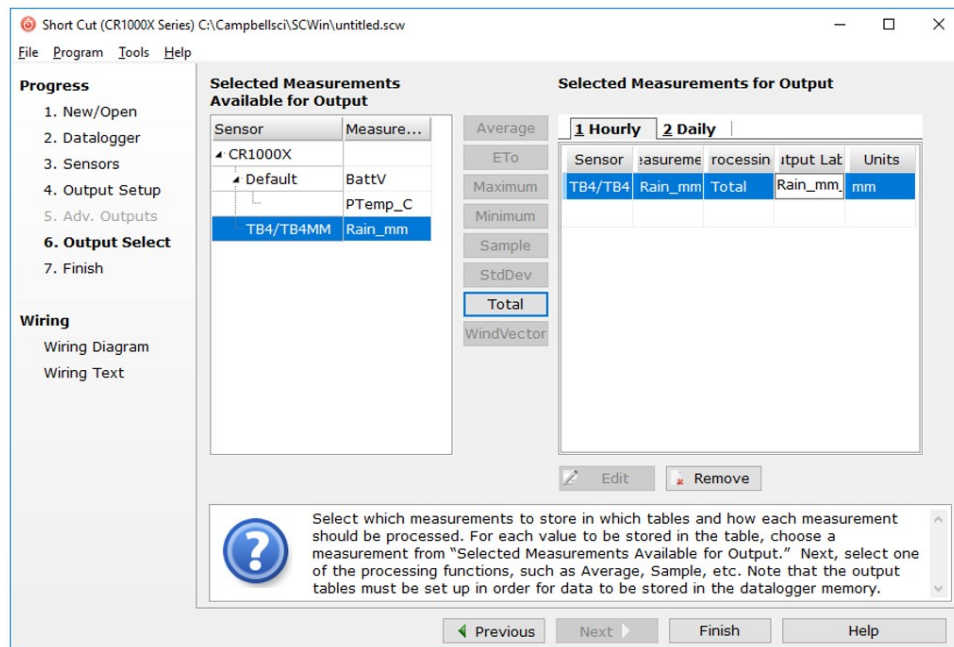

- Click **Finish** and save the program. Send the program to the data logger if the data logger is connected to the computer.

9. If the sensor is connected to the data logger, check the output of the sensor in the data display in *LoggerNet*, *RTDAQ*, or *PC400* to make sure it is making reasonable measurements.

5. Overview

The TB4, TB4MM, CS700, and CS700H tipping bucket rain gages are manufactured by HS Hyquest Solutions Pty. Ltd. and modified for use with Campbell Scientific data loggers. These rain gages funnel precipitation into a bucket mechanism that tips when filled to a calibrated level (Figure 5-1 [p. 5]). The tipping mechanism activates a reed switch. The switch closure is recorded by the data logger. When the bucket tips, the water drains out the screened fittings in the base of the gage.

The rain gages are ideal for locations where intense rainfall events may occur. They include a siphoning mechanism that allows the rain to flow at a steady rate regardless of rainfall intensity. The siphon reduces typical rain bucket errors and produces accurate measurements for up to 50 cm per hour.



Figure 5-1. CS700 bucket mechanism (housing not shown)

The CS700H has two power configuration options (either AC or DC) for powering the heater. With the AC option, a Phoenix Contact Power Supply is shipped with the CS700H (Figure 5-2 [p. 6]). [Phoenix Contact power supply specifications](#) (p. 55) provides more information about this power supply.



Figure 5-2. Phoenix Contact Power Supply

With the DC option, the CS700H is connected to a user-supplied battery. This option is ideal for remote sites using wind or solar power to recharge the battery. Battery capacity requirements vary according to the application and site location.

Features:

- More accurate measurement of high-intensity precipitation
- High precision
- Compatible with Campbell Scientific CRBasic data loggers: CR6, CR1000X, CR800 series, CR350-series, CR300 series (except CS700H), CR3000, and CR1000

5.1 Wind screen

The 260-953 Alter-Type Wind Screen can be used with the rain gage to minimize the effects of strong winds. Siting information and the installation procedure for this wind screen is provided in our 260-953 manual.

6. Specifications

Orifice diameter:	200 mm (7.87 in)
Measurement range:	0 to 700 mm/hr (0 to 27.6 in/hr)
Accuracy:	±2% @ < 250 mm/hr (9.8 in/hr); ±3% @ 250 to 500 mm/hr (9.8 to 19.7 in/hr)
Resolution	
TB4, CS700, CS700H:	0.254 mm (0.01 in)
TB4MM	0.2 mm (0.008 in)
Temperature range	
TB4, TB4MM, CS700:	0 to 70 °C
CS700H:	-40 to 70 °C
Humidity:	0 to 100%
Contact:	Dual Reed Switch
Drain tube:	Both filters accept 12 mm inner diameter tubing
Siphon:	0.4 mm (12 ml) capacity of rainfall; made from brass with a non-hydroscopic outer case. The syphon can be dismantled for routine cleaning and servicing.
Weight with 25-ft signal cable	
TB4/TB4MM:	2 kg (4.4 lb)
CS700/CS700H:	3.3 kg (7.4 lb)
Height	
TB4/TB4MM:	33 cm (13 in)
CS700/CS700H:	34.2 cm (13.5 in)

6.1 Heated rain gage

Snow sensor and heater

operating temperature range: -20 to 5 °C

Output: SDI-12

Voltage requirements

Main power: 10 to 30 VDC or 12 to 28 VAC

SDI-12 power: 9.6 to 16 VDC

Total current consumption

Snow sensor off, heater off: 6 mA @ 12 V, 0.072 W

Snow sensor on, heater off: 12 mA @ 12 V, 0.144 W

Snow sensor on, heater on: 5.8 A @ 12 V, 70 W

NOTE:

Specifications for the power supply used for the –AC option is provided in [Phoenix Contact power supply specifications](#) (p. 55).

7. Installation

If programming the data logger with *Short Cut*, skip [Wiring](#) (p. 9) and [Data logger programming](#) (p. 11). *Short Cut* does this work for you. See [QuickStart](#) (p. 2) for a *Short Cut* tutorial.

7.1 Wiring

7.1.1 TB4, TB4M, or CS700 connections

Wire color	Wire function	Data logger connections using a pulse terminal	Data logger connections using a control terminal
Black	Rain signal	P, P_SW, or U ¹ (pulse terminal)	C (control terminal)
White	Rain signal reference	⏏ (analog ground)	5 V
Clear	Shield	⏏ (analog ground)	⏏ (analog ground)

¹U and C terminals are automatically configured by the measurement instruction.

7.1.2 CS700H heated rain gage connections

CAUTION:

The CS700H will only communicate over SDI-12 when both its sensor cable and power cable are connected.

The CS700H has both a sensor cable and a power cable (Figure 7-1 [p. 9]).



Figure 7-1. CS700H with cables

The sensor cable connects to the data logger (Table 7-2 [p. 10]). The power cable connects to the power supply (Table 7-3 [p. 10]). Figure 7-2 (p. 11) shows the terminals for connecting the power cable to the Phoenix Contact Power Supply.

Table 7-2: CS700H sensor cable wire color, wire function, and data Logger connection

Wire color	Wire function	Data logger connections using a pulse terminal	Data logger connections using a control terminal
Green	SDI-12	Odd-numbered C or U ¹ configured for SDI-12	Odd-numbered C or U ¹ configured for SDI-12
Red	SDI-12 power	12V	12V
Blue	SDI-12 power ground	G	G
Black	Rain signal	P or U ¹ (pulse terminal)	C ² (control terminal)
White	Rain signal reference	\perp (analog ground)	5 V
Clear	Shield	\perp (analog ground)	\perp (analog ground)

¹**U** and **C** terminals are automatically configured by the measurement instruction.

²When using a CR6 or CR1000X, a conflict occurs if the pulse measurement uses an even **C** terminal that immediately follows the SDI-12 terminal. For example, if **C1** is used for the SDI-12 terminal, do not use **C2** for the pulse terminal.

Table 7-3: CS700H power cable wire color, wire function, and power supply connection

Wire color	Description	Power supply
Red	+24 VDC	+
Black	Ground	-

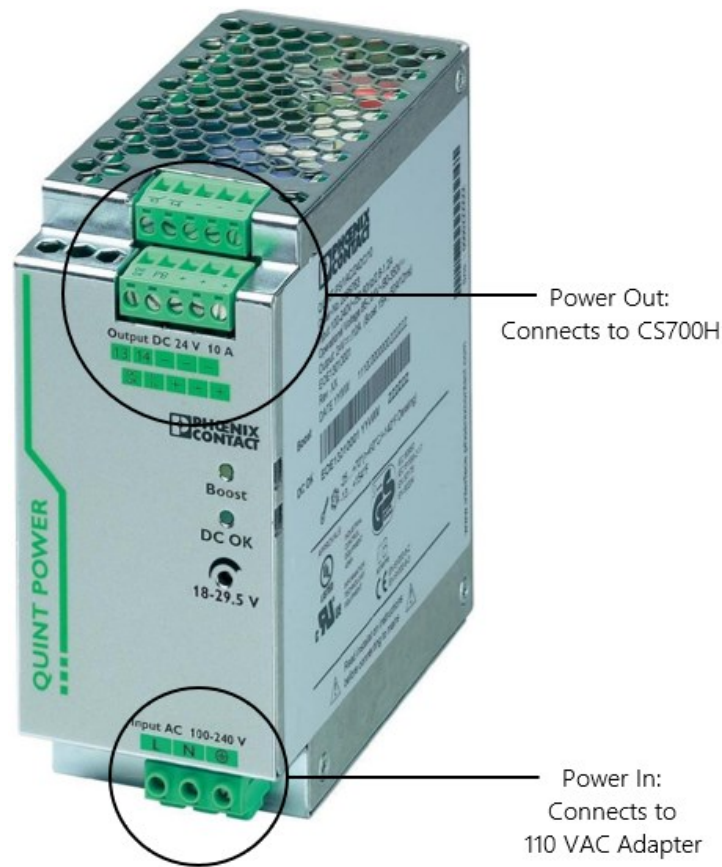

Figure 7-2. Phoenix Contact Power Supply

7.2 Data logger programming

Short Cut is the best source for up-to-date programming code for Campbell Scientific data loggers. If your data acquisition requirements are simple, you can probably create and maintain a data logger program exclusively with *Short Cut*. If your data acquisition needs are more complex, the files that *Short Cut* creates are a great source for programming code to start a new program or add to an existing custom program.

NOTE:

Short Cut cannot edit programs after they are imported and edited in *CRBasic Editor*.

A *Short Cut* tutorial is available in [QuickStart](#) (p. 2). If you wish to import *Short Cut* code into *CRBasic Editor* to create or add to a customized program, follow the procedure in [Importing Short Cut code into CRBasic Editor](#) (p. 28). Programming basics for CRBasic data loggers are provided in the following section. Complete program examples for select CRBasic data loggers can be found in [Example programs](#) (p. 29).

7.2.1 **PulseCount()** instruction

The tipping buckets use a reed switch for measuring precipitation. The **PulseCount()** CRBasic instruction measures the reed switch.

PulseCount(Dest, Repts, PChan, PConfig, POption, Mult, Offset)

- Choose Switch Closure for the **PConfig** parameter. For the CR6 and CR1000X, choose Switch Closure with pull up.
- The **Multiplier** parameter determines the units in which rainfall is reported. For the TB4, CS700, and CS700H, a multiplier of 0.01 converts the output to inches and a multiplier of 0.254 converts the output to millimeters. For the TB4MM, a multiplier of 0.2 converts the output to millimeters and a multiplier of 0.008 converts it to inches.

7.2.2 **SDI12Recorder()** instruction

When measuring a CS700H, the CRBasic program can include the **SDI12Recorder()** instruction to retrieve real-time status information stored in the CS700H microprocessor.

SDI12Recorder(Dest, SDIPort, SDIAddress, "SDICommand", Multiplier, Offset, FillNaN, WaitonTimeout)

The **Destination** parameter must be an array of length 9. **FillNaN** and **WaitonTimeout** are optional parameters (refer to *CRBasic Editor* help for more information). [CS700H operation details](#) (p. 37) provides information about the SDI-12 commands and other operational details for the CS700H.

CAUTION:

The CS700H will only communicate over SDI-12 when both its sensor cable and power cable are connected ([Table 7-2](#) [p. 10] and [Table 7-3](#) [p. 10]).

7.3 Siting

Mount the rain gage in a relatively level location representative of the surrounding area. Ensure that the orifice is horizontal, at least 1 m above the ground, and higher than the average snow depth.

Place the rain gage away from objects that obstruct the wind. The distance should be 2- to 4-times the height of the obstruction.

7.4 Mounting

The tipping buckets have three equally-spaced feet for mounting them on a flat surface. Each foot includes a hole that fits a 3/8-inch (M8) bolt. The three holes form a 234 mm (9.21 in) diameter bolt circle.

Campbell Scientific offers the CM240 mounting bracket for installing and leveling the rain gages. The CM240 may be attached to a CM300-Series mounting pole or to a user-supplied 1.5 in. IPS (1.9 in. OD) unthreaded pipe.

The pole or pipe can be placed directly into a concrete foundation (Figure 7-3 [p. 13]), or attached to a concrete foundation using J-bolts or self-supporting with legs (Figure 7-4 [p. 14]). A concrete pad is recommended, but it should not be installed over large paved or concrete surface.

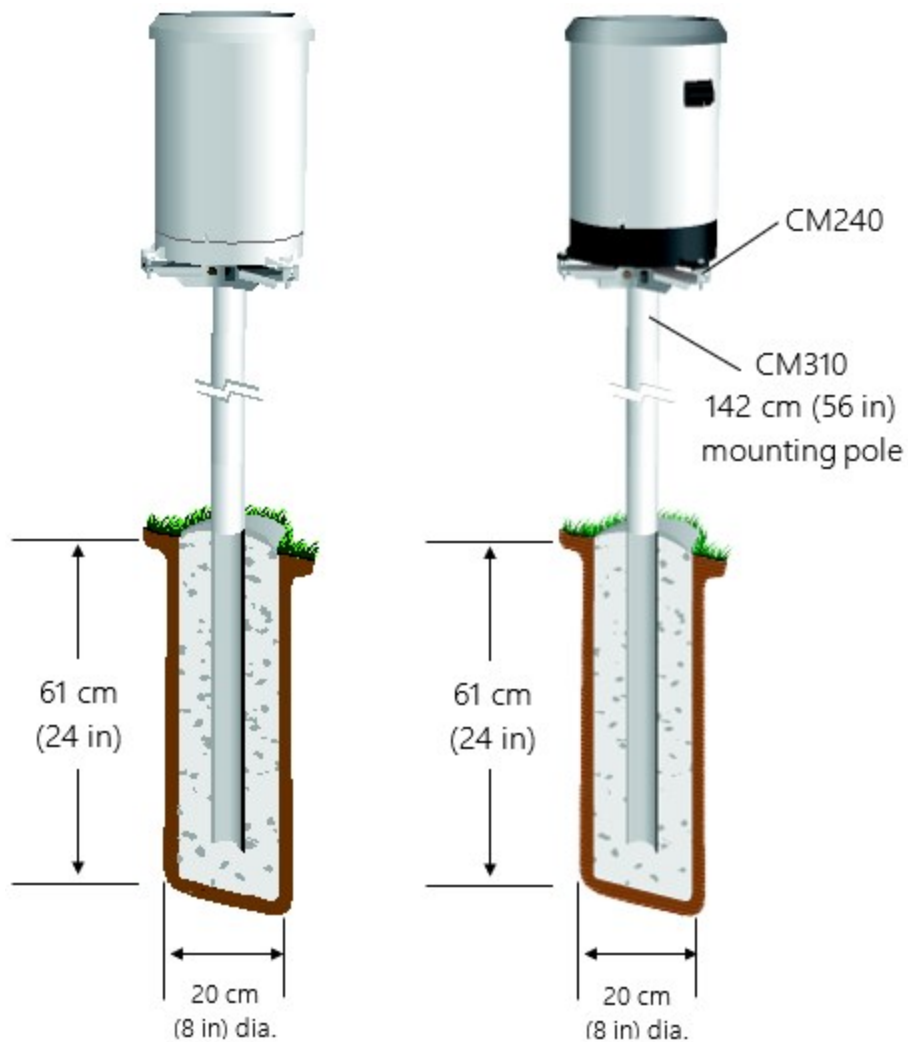

Figure 7-3. Typical rain gage installation

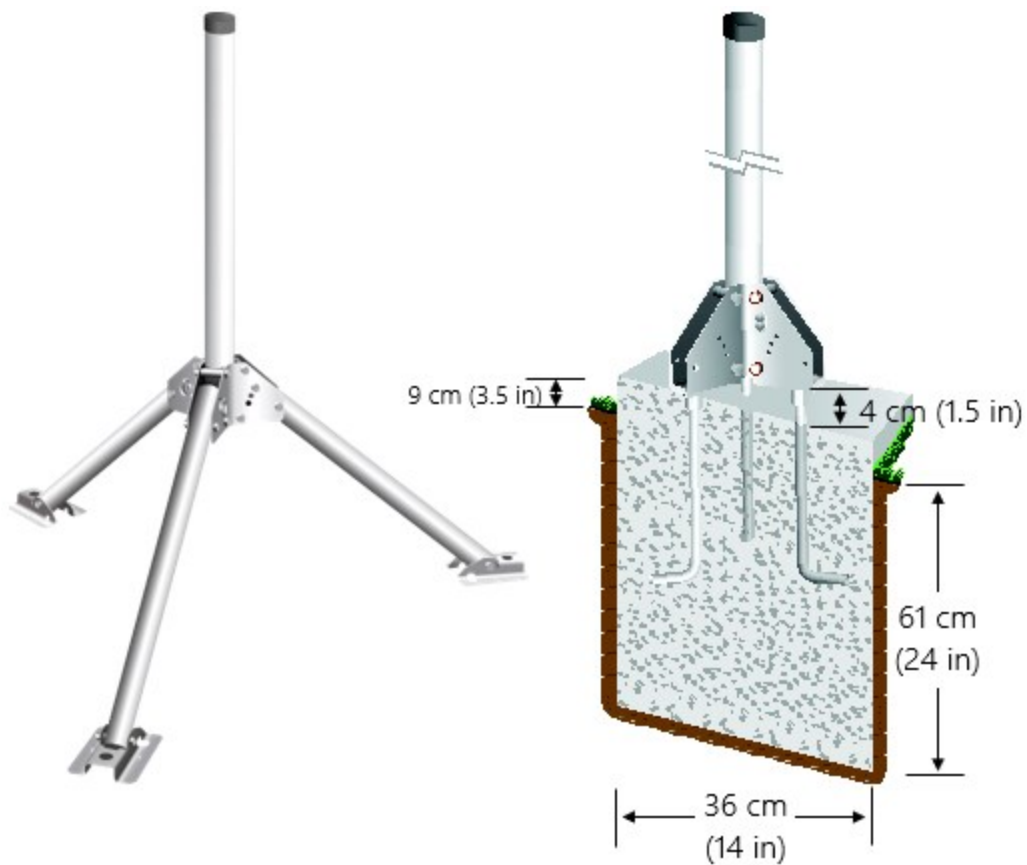

Figure 7-4. CM300 short leg pedestal option (left) and J-bolt pedestal option

7.4.1 Mounting to the CM240 and leveling

1. Remove the housing assembly from the base by loosening the three housing screws and lifting the housing upward (Figure 7-5 [p. 15]).



Figure 7-5. Transparent view of the TB4 (CS700 looks similar)

2. Remove the leveling screws from the CM240 (Figure 7-6 [p. 15]).

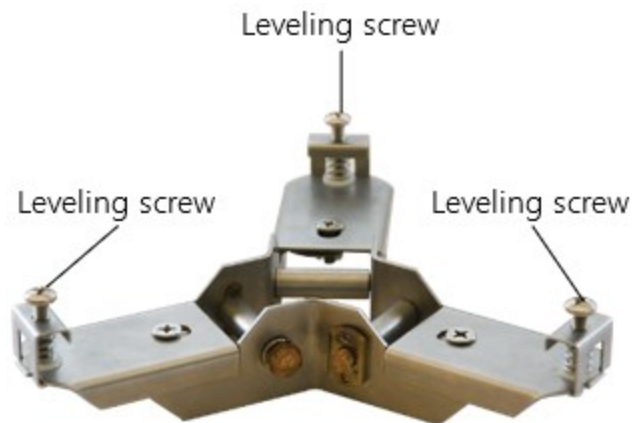

Figure 7-6. CM240 mounting bracket

3. Place the tipping bucket on the CM240 and line up the holes in the tipping bucket feet with the holes for the CM240 leveling screws (Figure 7-5 [p. 15] and Figure 7-6 [p. 15]).

4. Use the leveling screws to loosely secure the rain gage to the CM240.
5. Place the CM240 and rain gage on the mounting pole. The mounting pole fits up the middle of the CM240. Tighten the three bolts around the middle section of the CM240 to secure to the mounting pole.
6. Adjust the three leveling screws on the CM240 bracket to level the gage (Figure 7-6 [p. 15]). A bullseye level is mounted on the rain gage base to facilitate leveling (Figure 7-5 [p. 15]).
7. Remove the rubber band and cardboard securing the tipping bucket assembly. Tip the bucket several times to ensure the tipping mechanism is moving freely.
8. Replace the housing assembly and tighten the three housing screws to secure the housing to the base.

7.5 CS700H power supply installation

A CS700H with option –AC includes a Phoenix Contact Power Supply that must be housed in an environmental enclosure. A DIN rail mounting bracket is shipped with the CS700H for securing this power supply to an enclosure backplate. The DIN Rail mounts to the backplate using screws and grommets.

8. Operation

8.1 Sensor schematic

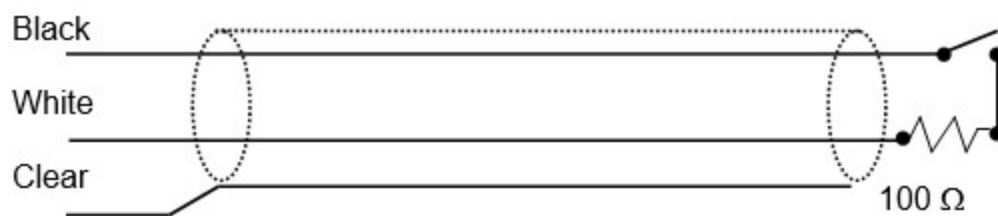

Figure 8-1. TB4, TB4M, and CS700 schematic

8.2 Long cable lengths

Long cables have appreciable capacitance between the lines. A built up charge could cause arcing when the switch closes, shortening switch life. A 100 ohm resistor is connected in series at

the switch to prevent arcing by limiting the current (Figure 8-1 [p. 16]). This resistor is installed on all rain gages currently sold by Campbell Scientific.

8.3 CS700H heated rain gage operation

NOTE:

This section provides a brief discussion of the CS700H heater operation. More in-depth information is provided in [CS700H operation details](#) (p. 37).

The CS700H includes heating elements and an internal snow sensor, which is activated when the air temperature drops below 4 °C. If the snow sensor detects snow in the catch area (funnel), the heating elements automatically turn on and keep the funnel temperature at 10 °C. The heater goes into a wait mode when snow has not been detected for 18 minutes. It automatically deactivates when the air temperature drops below -20 °C.

As the ambient temperature falls below the **Active On Temperature** (default 4 °C), the heater will turn on to heat the funnel area of the rain gage. Once the funnel reaches the **Funnel Set Point Temp** (default 10 °C), the heater will begin cycling on and off with a duty cycle dependent on the ambient temperature, keeping the funnel temperature at or near 10 °C (Figure 8-2 [p. 17]).

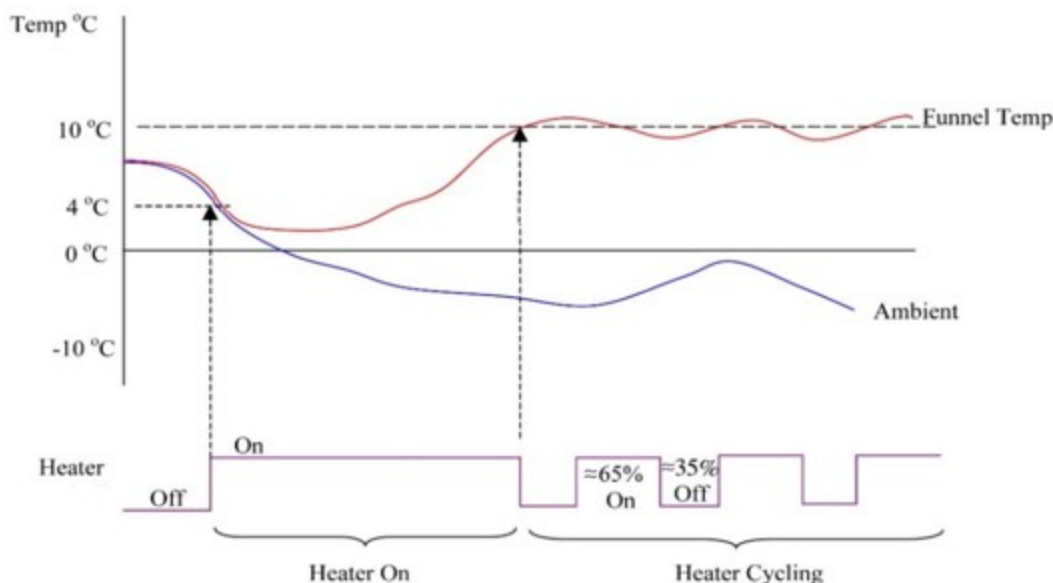

Figure 8-2. CS700H heater operation

8.3.1 SDI-12 measurement commands

The **M!**, **C!**, and **R!** SDI-12 commands retrieve the following status information from the CS700H:



1. Ambient temperature (°C or °F)
2. Block temperature (°C or °F)
3. Units (0=°C, 1=°F)
4. 0 = no snow; 1=snow detected
5. 0 = snow sensor disabled; 1=snow sensor enabled
6. 0 = heater elements off; 1=heater elements on
7. 0 = automatic control; 1>manual control
8. 0 = cycle disabled; 1=cycle enabled
9. Low Power Heater cycle time left (mins)

When using an **M!** command, the data logger waits for the time specified by the sensor, sends the **D!** command, pauses its operation, and waits until either it receives the data from the sensor or the sensor timeout expires. If the data logger receives no response, it will send the command a total of three times, with three retries for each attempt, or until a response is received. Because of the delays this command requires, it is only recommended in measurement scans of 10 seconds or more or use [SlowSequence](#).

A **C!** command follows the same pattern as an **M!** command with the exception that it does not require the data logger to pause its operation until the values are ready. Rather, the data logger picks up the data with the **D!** command on the next pass through the program. Another measurement request is then sent so that data is ready on the next scan. To use this command, the scan interval should be 10 seconds or less.

An **R!** command switches the sensor to automatically make measurements and send data every 11 seconds, ± 2 seconds, based on the sensor internal clock. If measurements are requested at 2 seconds or faster, the sensor will increase its measurement rate to approximately every 5 seconds. This instruction usually takes less than 300 milliseconds to execute. The automatic measurement mode can only be cancelled by powering down the sensor to reset it.

[SDI-12 sensor support](#) (p. 44) provides detailed information about the SDI-12 interface.

Additional SDI—12 information is also available at www.sdi-12.org , or www.youtube.com/user/CampbellScientific .

8.3.2 CS700H extended commands

The CS700H uses extended commands (X) to control the heater and change settings. The available extended commands are shown in the following table. Default values are shown in [Table C-1](#) (p. 37).

Table 8-1: CS700H extended SDI-12 commands	
SDI-12 command ¹	Function
aX20+x! Where, x = 0 Automatic Control x = 1 External Control	Get the external control state using the aD0! command. 0 = Automatic control. CS700H controls heater based on internal snow and ambient temperature sensor measurements. 1 = External control. Data logger program controls heater based on external sensor measurements. Refer to Operating modes (p. 42) for more information.
aX21+x! Where, x = 0 Heater element off x = 1 Heater element on	Get heater control state using the aD0! command. This command only operates if the external control is set to 1 (aX20+1!). 0 = Heater Elements Off 1 = Heater Elements On. Changing this state disables the cycle (aX29+0!)
aX22+x! Where, x = 0 Snow sensor enabled x = 1 Snow sensor disabled	Get snow sensor enabled status using the aD0! command. 0 = Snow sensor disabled. When the snow sensor is disabled, the unit reports snow as detected to force a heating cycle when the ambient temperature is less than the Active On temperature when in Automatic mode. The Active On temperature is described in the next row. 1 = Snow sensor enabled
aX23+xx.x! Where, xx.x = ActiveOn temperature	Get the ActiveOn temperature using the aD0! command. Set ActiveOn temperature to +4.0 °C (aX23+04.0!) if temperature units are Celsius (aX28+0!). Set ActiveON temperature to +39.2 °F (aX23+39.2!) if temperature units are Fahrenheit (aX28+1!).

Table 8-1: CS700H extended SDI-12 commands	
SDI-12 command ¹	Function
aX24+xx.x! Where, xx.x = ActiveOff temperature	Get the ActiveOff temperature using the aD0! command. Set ActiveOff temperature to +5.0 °C (aX24+05.0!) if temperature units are Celsius (aX28+0!). Set ActiveOff temperature to +41.0 °F (aX24+41.0!) if temperature units are Fahrenheit (aX28+1!).
aX25-xx.x! or aX25+xx.x! Where, xx.x = LowOff temperature	Get the LowOff temperature using the aD0! command. Set LowOff temperature to -15.0 °C (aX25-15.0!) if temperature units are Celsius (aX28+0!). Set LowON temperature to +05.0 °F (aX25+05.0!) if temperature units are Fahrenheit (aX28+1!).
aX26+xx.x! Where, xx.x = SetPoint temperature	Get the funnel SetPoint temperature using the aD0! command. Set SetPoint temperature to +10.0 °C (aX26+10.0!) if temperature units are Celsius (aX28+0!). Set ActiveON temperature to +501.0 °F (aX26+50.0!) if temperature units are Fahrenheit (aX28+1!).
aX27+xx! Where, xx = run time (min)	Get the Snow Run-on time after snow is detected using aD0! Typically, this is set to 18 minutes (aX27+18!)
aX28+x! Where, x = 0 Celsius x = 1 Fahrenheit	Get the temperature units using the aD0! command. 0 = Celsius (aX28+0!) 1 = Fahrenheit (aX28+1!)
aX29+x! Where, x = 0 Heating cycle off x = 1 Heating cycle on	Get cycle enabled data using the aD0! command. This command only operates if the external control is set to 1 (aX20+1!). 0 = heating cycle off (aX29+0!) 1 = heating cycle on (aX29+1!)
aX99+1!	Set the factory defaults (only when data is +1)

¹a is the SDI-12 address. In the [SDI12Recorder\(\)](#) CRBasic instruction, the command parameter does not include the SDI-12 address because the address is a separate parameter.

9. Troubleshooting and maintenance

NOTE:

All factory repairs and recalibrations require a returned material authorization (RMA) and completion of the "Statement of Product Cleanliness and Decontamination" form. Refer to the [Assistance](#) page at the end of this manual for more information.

9.1 Troubleshooting

Symptom: No precipitation measurement

1. Check that the sensor is wired to the pulse or control terminal specified by the pulse count instruction.
2. Verify that the **PConfig**, and **Multiplier** and **Offset** parameters for the **PulseCount()** instruction are correct for the data logger type.
3. Disconnect the sensor from the data logger and use an ohm meter to do a continuity check of the switch. The resistance measured at the terminal block on the inside of the bucket between the black and white wires should vary from infinite (switch open) when the bucket is tipped, to less than an ohm when the bucket is balanced.

Symptom: CS700H not communicating over SDI-12

1. Ensure that both the sensor and power cables are properly connected ([Table 7-2](#) [p. 10] and [Table 7-3](#) [p. 10]).

9.2 Maintenance

During each site visit, remove any debris, such as insects or sediment from the collection funnel, debris screen, siphoning mechanism, or tipping bucket assembly.

Verify the tipping bucket assembly moves freely, and that the data logger records each bucket tip.

9.2.1 Dismantling for cleaning

Regularly check the following items for cleanliness:

- Catch filter
- Siphon
- Interior of bucket
- Top surface of adjusting screws
- Housing locking screws; lightly lubricate after cleaning
- Insect screens

To access them, dismantle the rain gage using the following procedure:

1. Remove the housing assembly from the base by loosening the three housing screws and lifting the housing upward (Figure 9-1 [p. 22], Figure 9-2 [p. 23]).



Figure 9-1. Main components of the CS700

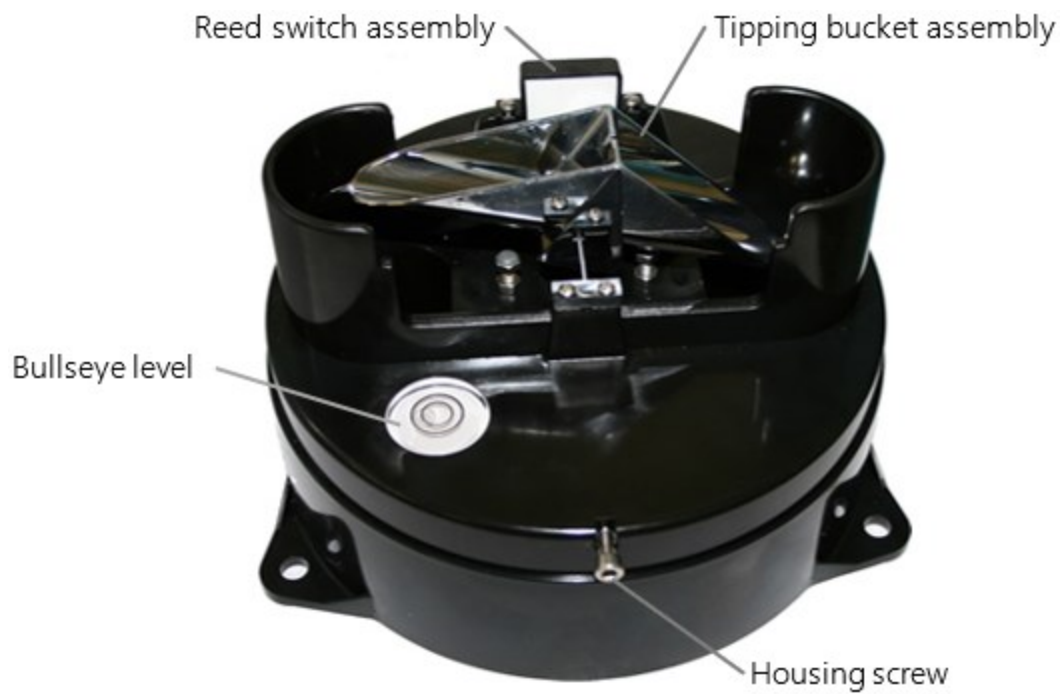

Figure 9-2. TB4 base

2. Separate the filter/siphon assembly from the funnel by pushing the filter while pulling the siphon ([Figure 9-3](#) [p. 24]).

CAUTION:

Do not twist the filter/siphon assembly while pushing and pulling.

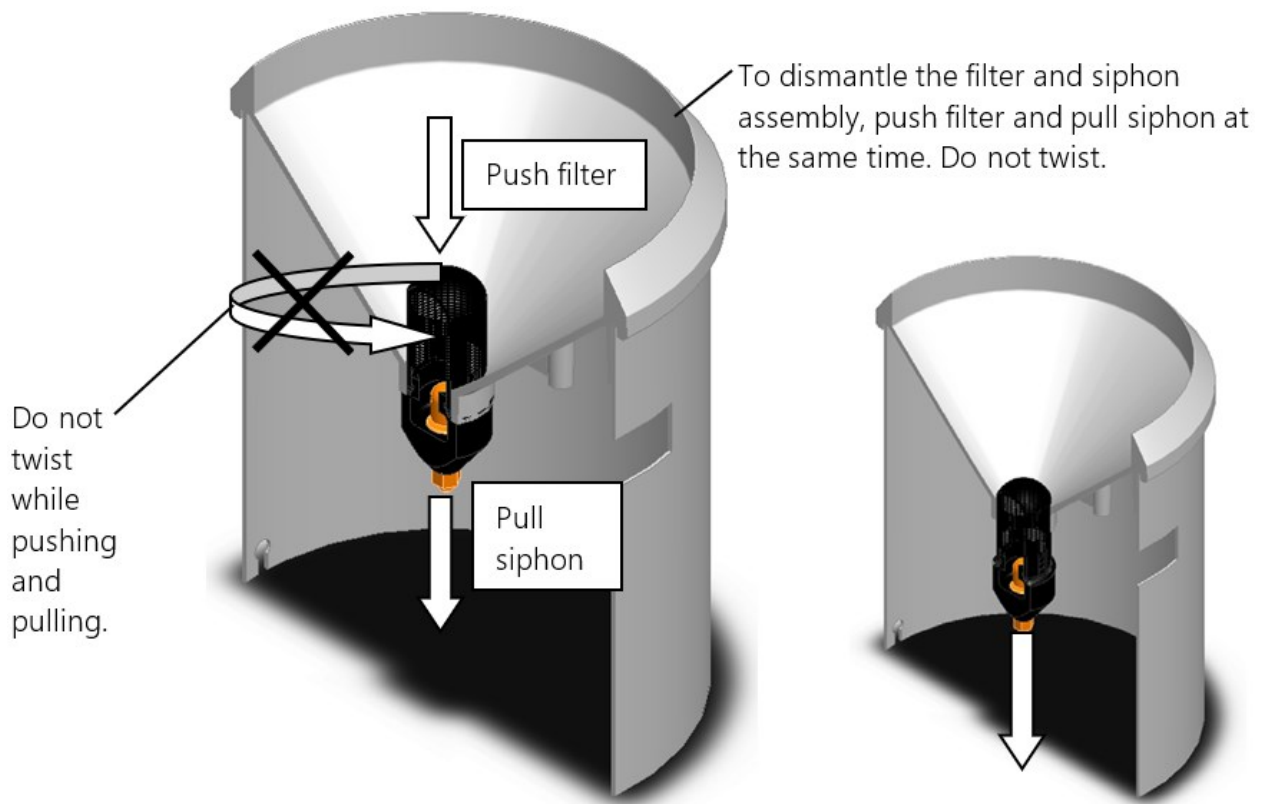

Figure 9-3. Dismantling the filter/siphon assembly

3. Disassemble the filter/siphon assembly by doing the following (Figure 9-4 [p. 25]):
 - a. Unscrew nut
 - b. Lightly press stem down on surface until stem pops out of siphon body
 - c. Remove stem from siphon body
 - d. Unscrew cap
 - e. Clean all items



Figure 9-4. Filter/siphon assembly

9.2.2 Reassembling the rain bucket

1. Screw cap on stem; finger tighten only (Figure 9-4 [p. 25]).
2. Push stem into siphon body (Figure 9-4 [p. 25]).

3. Replace nut and tighten (Figure 9-4 [p. 25]).

CAUTION:

Do not over tighten.

4. Push filter/siphon assembly back into place (Figure 9-5 [p. 26]).

CAUTION:

Do not twist the filter/siphon assembly while putting it back into place.

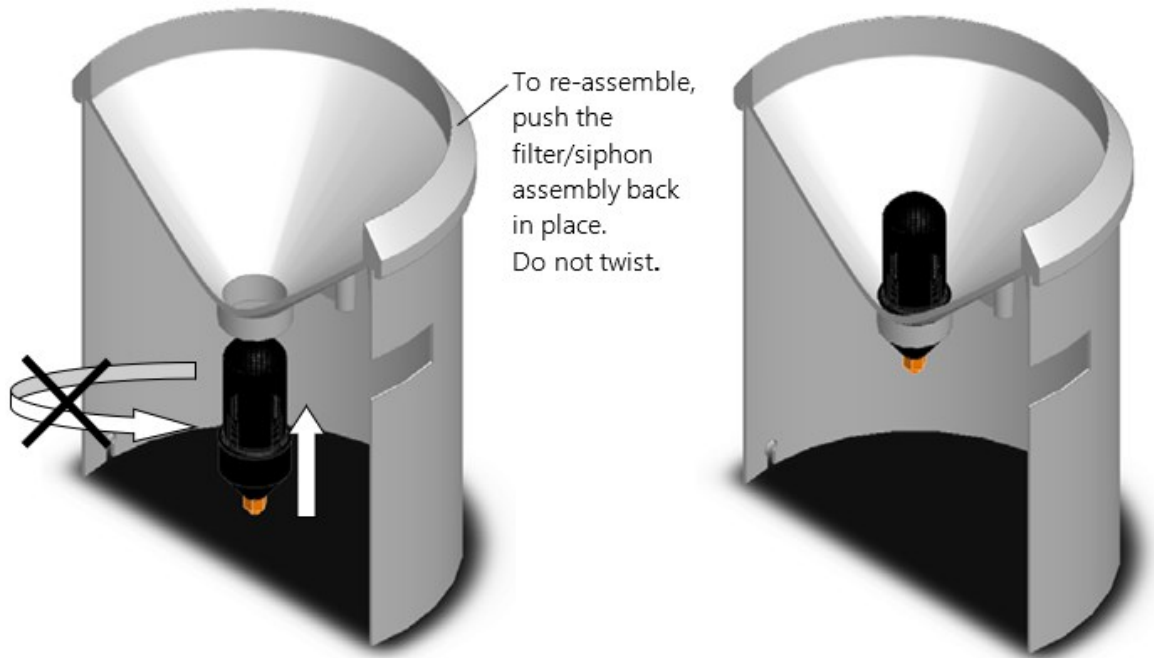

Figure 9-5. Reassembling the CS700

5. Place the housing assembly back onto the base and tighten the three screws that secure the housing onto the base.

9.3 Calibration check

The sensor is factory calibrated; recalibration is not required unless damage has occurred or the adjustment screws have loosened.

Nevertheless, the following calibration check is recommended once every 12 months:

1. Remove the housing assembly from the base by removing the three screws and lifting upward on the housing.

2. Check the bubble level to verify the rain gage is level.
3. Pour water through the inner funnel to wet the two bucket surfaces. Using a graduated cylinder, slowly pour 314 cc (19.16 in³) of water, over a 15-minute period, into the collection funnel. This volume of water is equal to 0.39 in of rainfall (10 mm).
4. After the water has passed through the rain gage, the tipping bucket should have tipped 39 times.
5. If the rain gage fails to record the correct number of tips, return the unit to Campbell Scientific for recalibration (see [Assistance](#) at the back of this manual).

Appendix A. Importing *Short Cut* code into *CRBasic Editor*

Short Cut creates a .DEF file that contains wiring information and a program file that can be imported into *CRBasic Editor*. By default, these files reside in the C:\campbellsci\SCWin folder.

Import *Short Cut* program file and wiring information into *CRBasic Editor*:

1. Create the *Short Cut* program, then save it. Click the **Advanced** tab then the **CRBasic Editor** button. Your program file will open in CRBasic with a generic name. Provide a meaningful name and save the CRBasic program. This program can now be edited for additional refinement.

NOTE:

Once the file is edited with *CRBasic Editor*, *Short Cut* can no longer be used to edit the program.

2. To add the *Short Cut* wiring information into the new CRBasic program, open the .DEF file located in the C:\campbellsci\SCWin folder. Copy the wiring information found at the beginning of the .DEF file.
3. Go into the CRBasic program and paste the wiring information at the beginning of the program.
4. In the CRBasic program, highlight the wiring information, right-click, and select **Comment Block**. This adds an apostrophe (') to the beginning of each of the highlighted lines, which instructs the data logger compiler to ignore those lines when compiling. The **Comment Block** feature is demonstrated at about 5:10 in the [CRBasic | Features](#) video .

Appendix B. Example programs

B.1 TB4 or CS700 example programs

B.1.1 CR6 program for the TB4 or CS700

In the following CR6 program, the TB4 or CS700 is connected to U1, and the rain measurements are reported in inches. Battery voltage and panel temperature are also measured.

CRBasic Example 1: CR6 program measuring the TB4 or CS700

```
'Program measures one TB4 or CS700

'Wiring Diagram
'=====
'Wire
'Color      Function                Terminal
'-----    -
'Black      Rain signal                       U1
'White      Rain signal ground                 Ground Symbol
'Clear      Shield                       Ground Symbol

'Declare Variables and Units
Public BattV
Public PTemp_C
Public Rain_in

Units BattV = Volts
Units PTemp_C = Deg C
Units Rain_in = inch

'Define Data Tables
DataTable(OneMin,True,-1)
  DataInterval(0,1,Min,10)
  Totalize(1,Rain_in,FP2,False)
EndTable

DataTable(OneDay,True,-1)
  DataInterval(0,1440,Min,10)
  Minimum(1,BattV,FP2,False,False)
  Totalize(1,Rain_in,FP2,False)
EndTable

'Main Program
```

CRBasic Example 1: CR6 program measuring the TB4 or CS700

```
BeginProg
  Scan(5,Sec,1,0)
    'Default Data Logger Battery Voltage measurement BattV
  Battery(BattV)
    'Default Data Logger Wiring Panel Temperature measurement 'PTemp_C'
  PanelTemp(PTemp_C,60)
    'Rain Gage measurement Rain_in
  PulseCount(Rain_in,1,U1,1,0,0.01,0)
    'Call Data Tables and Store Data
  CallTable OneMin
  CallTable OneDay
  NextScan
EndProg
```

B.1.2 CR1000X programs for the TB4 or CS700

This section includes two CR1000X programs. In the first program, the rain gage is connected to **P1**, and the rain measurements are reported in inches. Battery voltage and panel temperature are also measured. In the second program, the rain gage is connected to **C1**, and the rain measurements are reported in millimeters.

CRBasic Example 2: CR1000X program using a pulse terminal to measure the TB4 or CS700

```
'Program measures one TB4 or CS700

'Wiring Diagram
'=====
'Wire
'Color      Function                Terminal
'-----    -
'Black      Rain signal                    P1
'White      Rain signal ground            Ground Symbol
'Clear      Shield                    Ground Symbol

'Declare Variables and Units
Public BattV
Public PTemp_C
Public Rain_in

Units BattV = Volts
Units PTemp_C = Deg C
Units Rain_in = inch

'Define Data Tables
DataTable(OneMin,True,-1)
  DataInterval(0,1,Min,10)
  Totalize(1,Rain_in,FP2,False)
EndTable

DataTable(OneDay,True,-1)
  DataInterval(0,1440,Min,10)
  Minimum(1,BattV,FP2,False,False)
  Totalize(1,Rain_in,FP2,False)
EndTable

'Main Program
BeginProg
  Scan(5,Sec,1,0)
  'Default Data Logger Battery Voltage measurement BattV
  Battery(BattV)
  'Default CR1000X Data Logger Wiring Panel Temperature measurement 'PTemp_C'
  PanelTemp(PTemp_C,60)
  'CS700 Rain Gage measurement Rain_in
  PulseCount(Rain_in,1,P1,1,0,0.01,0)
  'Call Data Tables and Store Data
  CallTable OneMin
  CallTable OneDay
  NextScan
EndProg
```

CRBasic Example 3: CR1000X program using a control terminal to measure the TB4 or CS700

```
'CR1000X
'Program measures one rain gage using control terminal

'Wiring Diagram
'=====
'Wire
'Color      Function                Terminal
'-----
'Black      Rain signal                    C1
'White      Rain signal ground             5V
'Clear      Shield                        Ground Symbol

'Declare Public Variables and Units
Public Rain_mm
Units Rain_mm=mm

DataTable(Rain,True,-1)
  DataInterval(0,60,Min,0)
  Totalize(1,Rain_mm,FP2,0)
EndTable

'Main Program
BeginProg
  Scan(1,Sec,1,0)
  PulseCount(Rain_mm,1,C1,2,0,.254,0)
  CallTable(Rain)
  NextScan
EndProg
```

B.2 CS700H example programs

B.2.1 CR6 program for the CS700H

In the following CR6 program, the CS700H is connected to **U1**, and the rain measurements are reported in inches. This program does not retrieve real-time status information using the SDI-12 protocol. An example program that retrieves status information is provided in [CR1000X programs for CS700H](#) (p. 34).

CRBasic Example 4: CR6 program measuring the CS700H

```

'Program measures one CS700H

'Wiring Diagram
'=====
'CS700H
'Wire
'Color      Function                Terminal
'-----    -
'Black      Rain signal                       U1
'White      Rain signal ground           Ground Symbol
'Clear      Shield                       Ground Symbol

'Declare Variables and Units
Public BattV
Public PTemp_C
Public Rain_in

Units BattV = Volts
Units PTemp_C = Deg C
Units Rain_in = inch

'Define Data Tables
DataTable(OneMin,True,-1)
    DataInterval(0,1,Min,10)
    Totalize(1,Rain_in,FP2,False)
EndTable

DataTable(OneDay,True,-1)
    DataInterval(0,1440,Min,10)
    Minimum(1,BattV,FP2,False,False)
    Totalize(1,Rain_in,FP2,False)
EndTable

'Main Program
BeginProg
    Scan(5,Sec,1,0)
        'Default Data Logger Battery Voltage measurement BattV
        Battery(BattV)
        'Default Data Logger Wiring Panel Temperature measurement 'PTemp_C'
        PanelTemp(PTemp_C,60)
        'CS700H Rain Gage measurement Rain_in
        PulseCount(Rain_in,1,U1,1,0,0.01,0)
        'Call Data Tables and Store Data
        CallTable OneMin
        CallTable OneDay
    NextScan
EndProg

```

B.2.2 CR1000X programs for CS700H

This section includes two CR1000X programs that measure the CS700H heated tipping bucket rain gage. Both programs measure precipitation (mm), battery voltage, and panel temperature. The second program also retrieves real time status information by using SDI-12 protocol.

CRBasic Example 5: CR1000X program measuring the CS700H

```
'Program measures one CS700H

'Wiring Diagram
'=====
'CS700H
'Wire
'Color      Function                Terminal
'-----
'Black      Rain signal                    P1
'White      Rain signal ground            Ground Symbol
'Clear      Shield                          Ground Symbol

'Declare Variables and Units
Public BattV
Public PTemp_C
Public Rain_in

Units BattV = Volts
Units PTemp_C = Deg C
Units Rain_in = inch

'Define Data Tables
DataTable(OneMin,True,-1)
  DataInterval(0,1,Min,10)
  Totalize(1,Rain_in,FP2,False)
EndTable

DataTable(OneDay,True,-1)
  DataInterval(0,1440,Min,10)
  Minimum(1,BattV,FP2,False,False)
  Totalize(1,Rain_in,FP2,False)
EndTable

'Main Program
BeginProg
  Scan(5,Sec,1,0)
  'Default Data Logger Battery Voltage measurement BattV
  Battery(BattV)
  'Default CR1000 Data Logger Wiring Panel Temperature measurement 'PTemp_C'
  PanelTemp(PTemp_C,_60Hz)
```

CRBasic Example 5: CR1000X program measuring the CS700H

```

'CS700H Rain Gage measurement Rain_in
PulseCount(Rain_in,1,P1,1,0,0.01,0)
'Call Data Tables and Store Data
CallTable OneMin
CallTable OneDay
NextScan
EndProg

```

CAUTION:

The CS700H will only communicate over SDI-12 when both its sensor cable and power cable are connected (Table 7-2 [p. 10] and Table 7-3 [p. 10]).

CRBasic Example 6: CR1000X program measuring the CS700H and monitoring heater

```

'Program measures one CS700H and monitors heater via SDI-12

'Wiring Diagram
'=====
'CS700H
'Wire
'Color      Function                Terminal
'-----
'Black      Rain signal                    P1
'White      Rain signal ground             Ground Symbol
'Clear      Shield                          Ground Symbol
'Green      SDI-12 signal                  C1
'Red        SDI-12 power                    12V
'Blue      SDI-12 ground                  G

'Declare Variables and Units
Public BattV
Public PTemp_C
Public Rain_in
Public Info(9)
Alias Info(1)=CS700H_AirTemp           'CS700H air temperature measurement
Alias Info(2)=CS700H_BlockTemp         'Heater block temperature
Alias Info(3)=CS700H_CO_F1             'Temperature units: 0 = deg C, 1 = deg F
Alias Info(4)=CS700H_NoSnow0_Snow1    'Snow detection
Alias Info(5)=CS700H_SnwSnsrActv      'Snow sensor on or off
Alias Info(6)=CS700H_Htr_On_off       'Heater on or off
Alias Info(7)=CS700H_Control_Auto_Man 'Automatic or Manual heater control
Alias Info(8)=CS700H_Cycle_Dis_Ena    'Heater cycle disabled or enabled
Alias Info(9)=CS700H_HTimeLeft        'Heater cycle time left in minutes

Units BattV = Volts
Units PTemp_C = Deg C

```

CRBasic Example 6: CR1000X program measuring the CS700H and monitoring heater

```
Units Rain_in = inch
```

```
'Define Data Tables
```

```
DataTable(OneMin,True,-1)  
  DataInterval(0,1,Min,10)  
  Totalize(1,Rain_in,FP2,False)  
  Sample(1,CS700H_AirTemp,FP2)  
  Sample(1,CS700H_BlockTemp,FP2)  
  Sample(1,CS700H_CO_F1,FP2)  
  Sample(1,CS700H_NoSnow0_Snow1,FP2)  
  Sample(1,CS700H_SnwSnsrActv,FP2)  
  Sample(1,CS700H_Htr_On_off,FP2)  
  Sample(1,CS700H_Control_Auto_Man,FP2)  
  Sample(1,CS700H_Cycle_Dis_Ena,FP2)  
  Sample(1,CS700H_HTimeLeft,FP2)  
EndTable
```

```
DataTable(OneDay,True,-1)  
  DataInterval(0,1440,Min,10)  
  Minimum(1,BattV,FP2,False,False)  
  Totalize(1,Rain_in,FP2,False)  
EndTable
```

```
'Main Program
```

```
BeginProg  
  Scan(10,Sec,1,0)  
    'Default Data Logger Battery Voltage measurement BattV  
    Battery(BattV)  
    'Default Data Logger Wiring Panel Temperature measurement 'PTemp_C'  
    PanelTemp(PTemp_C,_60Hz)  
    'CS700H Rain Gage measurement Rain_in  
    PulseCount(Rain_in,1,P1,1,0,0.01,0)  
    'SDI-12 Sensor measurements  
    SDI12Recorder(Info(),C1,0,"M!",1,0)  
    'Call Data Tables and Store Data  
    CallTable OneMin  
    CallTable OneDay  
  NextScan  
EndProg
```

Appendix C. CS700H operation details

CAUTION:

Factory settings have been set to adequately measure precipitation during cold precipitation events. Changing these settings is not recommended, and doing so may change the data outcome or render the sensor inoperable.

Table C-1 (p. 37) shows the CS700H factory default settings for adequately measuring precipitation during cold precipitation. Additionally, the default setting for the SDI-12 address is zero. Refer to [CS700H extended commands](#) (p. 19) for a description of the commands.

External Control Off (Auto)	(aX20! Command) = 0
Snow Sensor Enabled	(aX22! Command) = 1
Active On Temperature 4 °C	(aX23! Command)
Active Off Temperature 5 °C	(aX24! Command)
Low Off Temperature –20 °C	(aX25! Command)
Funnel Set Point Temp 10°C	(aX26! Command)
Snow Run-On Time 18 mins	(aX27! Command)
Units °C	(aX28! Command) = 0
SDI-12 Address 0	(aAb! Command to change address; ?! Command to query address)

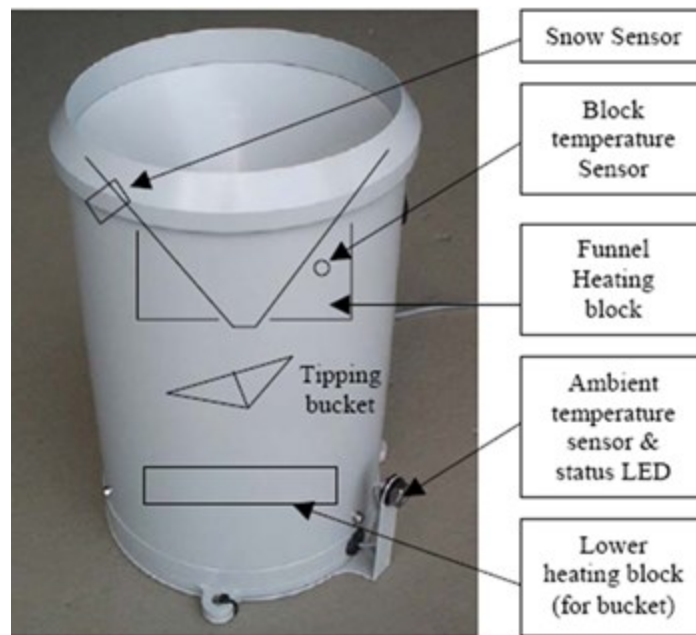

Figure C-1. Locations of the CS700H heater components

When the CS700H is not active, the status LED flashes every 1.5 s.

When the ambient temperature sensor detects the temperature falling below the **Active On temperature (4 °C)** then the system becomes active and the snow sensor is enabled (Figure C-2 [p. 39]). The status LED flashes slightly faster at 2 flashes per second—indicating the system is active.

When the proximity sensor detects snow (for 5 s continuously), the heater elements are turned on and the block temperature sensor is monitored. The heaters are controlled so that the temperature inside the funnel reaches the **Set Point temperature (10 °C)**.

NOTE:

The actual block temperature will be higher than the set point as substantial heat is dissipated.

The lower heating block keeps the tipping bucket and the drain tubes from freezing up. While the heater elements are turned on, the status LED flashes even faster at eight flashes per second.

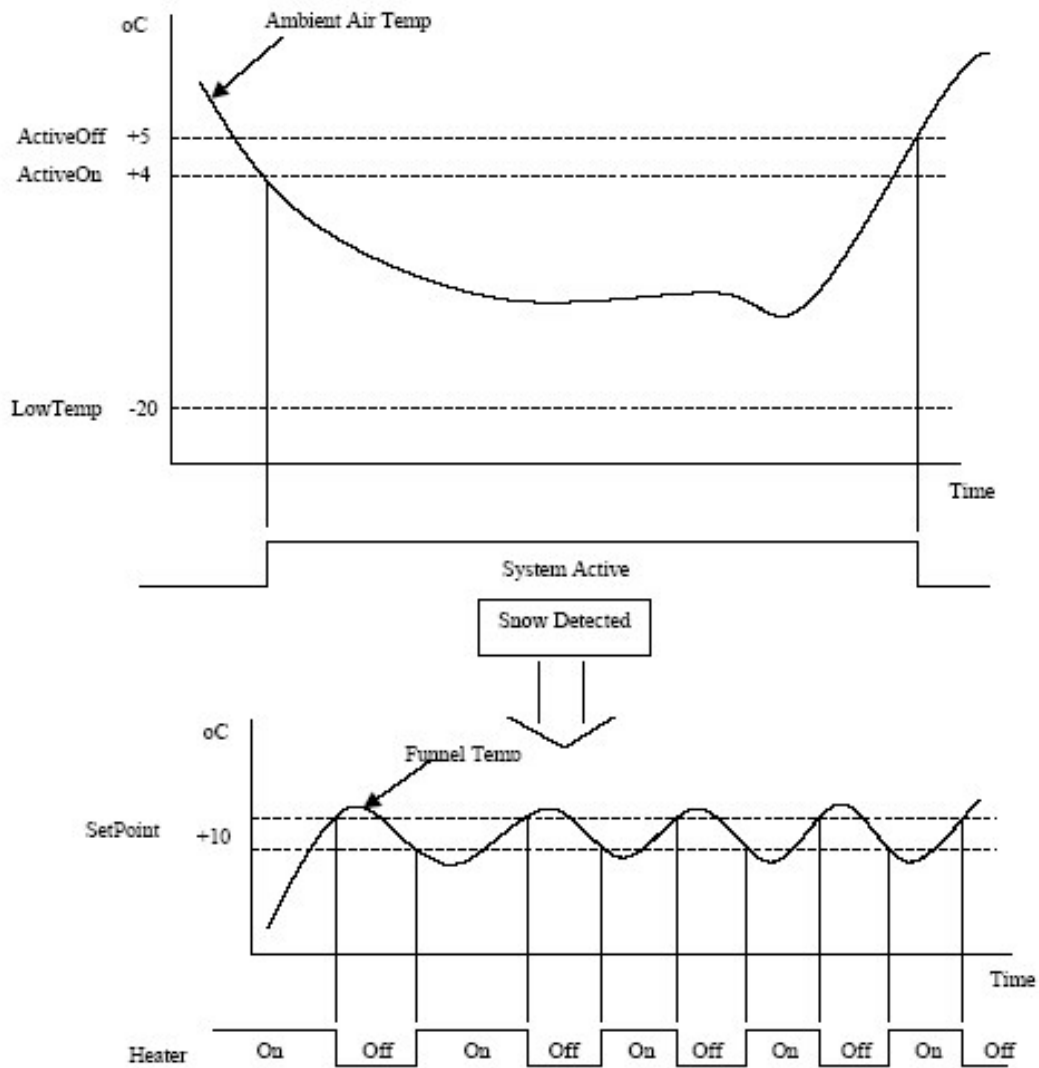

Figure C-2. Diagram depicting overall operation

When snow is last detected, a timer is left running to keep the heater cycling so that any snow built up on the funnel will be melted. The **Snow Run-on** timer is factory preset to 18 minutes but may be extended as required.

The heater will cycle on and off for the **Run-on** time or while ever snow is detected (see [Figure C-3](#) [p. 40]).

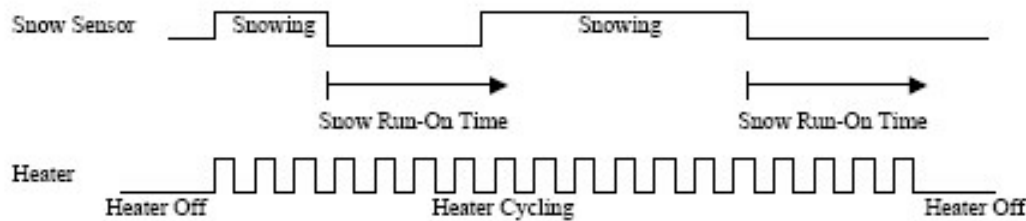

Figure C-3. Diagram showing how the "Snow Run-On" timer controls the heater

C.1 High power operation

If the snow sensor is disabled (`aX22+0!`), the heater will cycle continually when the ambient temperature falls below the **Active On Temperature** (`aX23!` command) and is above the **Low Off Temperature** (`aX25!` command). This assumes the system is active. Because this mode consumes more power, high power operation is only recommended when the CS700H uses AC power.

C.2 External control

By default, the CS700H is set to automatic control (`aX20+0!`), which controls the heater based on measurements from the internal ambient temperature and snow sensors. This method is described in [CS700H heated rain gage operation](#) (p. 17) and is the preferred method for many applications.

Data loggers in weather stations that monitor ambient temperature and snowfall can control the tipping bucket heaters directly. To do this, set the CS700H to external control (`aX20+1!`), then enable the heaters to cycle on/off (`aX29+1!`). The ambient temperature, block temperature, snow sensor and state of the heaters can be measured using the `aM!`, `aR!`, or `aC!` command, as normal.

NOTE:

The **Setpoint Temperature** is the funnel temperature and not the block temperature read from `aM!` and `aR!` commands. The relationship between the funnel temperature, block temperature, and ambient temperature has been determined through extensive testing.

For an alternative external control method, set the heater to external control (`aX20+1!`), then turn the heating elements on using the `aX21+1!` command. The heating elements will remain on until the data logger program issues the `aX21+0!` command.

CAUTION:

If the heating elements are left on, the funnel temperature may reach a point where the snow evaporates before it hits the funnel!

The [Operating modes](#) (p. 42) describe using the external heater control in more detail.

C.3 Status LED

The Status LED, within the ambient temperature sensor probe, flashes to indicate the mode that the CS700H is in (see [Table C-2](#) [p. 41]).

Mode	Flash rate	Description
Long Flash	LED on for 0.5 s	Controller powering up.
Slow Flash	1 flash every 1.5 s	In standby mode waiting for a heating cycle.
Medium Flash	2 flashes per second	Within a heating cycle and the heating elements are presently turned off. Waiting for snow to be present before turning on heaters.
Fast Flash	8 flashes per second	Within a heating cycle and the heating elements are presently turned on.

C.4 Snow sensor

The snow sensor is actually a capacitive proximity sensor that registers any material object within a few mm range. The sensor power is turned on and off to conserve power. [C.4](#) (p. 41) lists the conditions that power is applied.

The state of the snow sensor (snow detected) is read using the measure (**aM!**) and data (**aD0!**) commands (fourth value).

NOTE:

The snow sensor must detect snow continuously for 5 s before the detected flag is set to 1. And conversely, snow must be absent for 5 s continuously before the detected flag is reset to 0. This process prevents a premature heating cycle when in the automatic mode.

Table C-3: Snow sensor power options		
Mode (aX20! command)	Snow Enabled aX22! command	Description
Auto	0	Snow sensor isn't powered. Cannot detect real snow, instead it indicates snow is always present.
	1	Snow sensor only is powered only when the ambient temperature is below the Active On temperature. Only detects snow when the temperature is in this range.
Manual	0	Snow sensor isn't powered. Cannot detect real snow, instead it indicates snow is always present.
	1	Snow sensor always is powered, and can detect snow at any time.

C.5 Operating modes

The CS700H can be put into automatic or manual operation modes. [Table C-4](#) (p. 43) describes how the modes are entered and the operation of the modes.

Table C-4: Operating modes

Auto/ Manual X20	Cycle Enable X29	Heater On/Off X21	Snow Enabled X22	Snow	Description
0	X	X	1	0 / 1	Auto Mode: When the Ambient temperature falls below the Active On temperature X23, and Snow is detected, then a Heating Cycle is started. (That is, the heater elements are switched on and off to keep inside the funnel at the SetPoint temperature X26.) This is a low power mode, as the heater cycle only begins when snow is detected!
0	X	X	0	1	Auto Mode: Same as the previous, but because the snow sensor is disabled the snow detected flag is always set. The Heating Cycle is started when the Ambient temperature fall below the Active On temperature X23. This mode uses more power and should only be used when the system is supplied by mains power.

Table C-4: Operating modes

Auto/ Manual X20	Cycle Enable X29	Heater On/Off X21	Snow Enabled X22	Snow	Description
1	0/1	0	X	X	Manual Mode: The Cycle Enable flag X29 is used to force a Heating Cycle. This is set or cleared by another system at the site – as it determines whether heating is required. When the Cycle Enable flag is “0” the heaters are off. When the Cycle Enable flag is “1” then the Heating Cycle is started. (That is, the heater elements are switched on and off to keep inside the funnel at the SetPoint temperature X26.) The snow sensor state can be read using the measure/data commands, but its state is ignored when controlling the heaters.
1	0	0/1	X	X	Manual Mode: The heater elements can be controlled directly with the Heater On/Off flag X21. When the flag is “0” the heaters are off, and when the flag is “1” the heaters are on. Note that the heaters must be cycled by the controlling system in order to control the funnel temperature. This mode must be used with caution!

(X = Don't Care)

C.6 SDI-12 sensor support

NOTE:

The CS700H will only communicate over SDI-12 when both its sensor cable and power cable are connected ([Table 7-2](#) (p. 10) and [Table 7-3](#) [p. 10]).

C.6.1 Introduction

SDI-12, Serial Data Interface at 1200 baud, is a protocol developed to simplify sensor and data logger compatibility. Only three wires are necessary — serial data, ground, and 12 V. With unique

addresses, multiple SDI-12 sensors can connect to a single SDI-12 terminal on a Campbell Scientific data logger.

This appendix discusses the structure of SDI-12 commands and the process of querying SDI-12 sensors. For more detailed information, refer to version 1.4 of the SDI-12 protocol, available at www.sdi-12.org .

For additional information, refer to the [SDI-12 Sensors | Transparent Mode](#) and [SDI-12 Sensors | Watch or Sniffer Mode](#)  videos.

C.6.2 SDI-12 command basics

SDI-12 commands have three components:

- **Sensor address (a)** – a single character and the first character of the command. Use the default address of zero (0) unless multiple sensors are connected to the same port.
- **Command body** – an upper case letter (the “command”), optionally followed by one or more alphanumeric qualifiers.
- **Command termination (!)** – an exclamation mark.

An active sensor responds to each command. Responses have several standard forms and always terminate with <CR> <LF> (carriage return and line feed). Standard SDI-12 commands are listed in [Table C-5](#) (p. 45).

Name	Command	Response ¹
Acknowledge Active	a!	a<CR> <LF>
Send Identification	aI!	allccccccmmmmmmvvvxxx...xx <CR> <LF>
Start Verification	aV!	atttn <CR> <LF>
Address Query	?!	a<CR> <LF>
Change Address	aAb!	b<CR> <LF>
Start Measurement	aM! aM1! . . . aM9!	atttn<CR> <LF>
Send Data	aD0! . . . aD9!	a<values> <CR> <LF> or a<values> <CRC> <CR> <LF>
¹ Information on each of these commands is given in the following sections.		

C.6.2.1 Acknowledge active command (a!)

The Acknowledge Active command (a!) is used to test a sensor on the SDI-12 bus. An active sensor responds with its address.

C.6.2.2 Send identification command (aI!)

Sensor identifiers are requested by issuing command aI!. The reply is defined by the sensor manufacturer but usually includes the sensor address, SDI-12 version, manufacturer's name, and sensor model information. Serial number or other sensor specific information may also be included.

aI!	allccccccmmmmmmvvvxxx...xx<CR> <LF>
a	Sensor SDI-12 address
ll	SDI-12 version number (indicates compatibility)
ccccccc	8-character vendor identification
mmmmm	6 characters specifying the sensor model
vvv	3 characters specifying the sensor version (operating system)
xxx...xx	Up to 13 optional characters used for a serial number or other specific sensor information that is not relevant for operation of the data logger
<CR> <LF>	Terminates the response
Source: <i>SDI-12: A Serial-Digital Interface Standard for Microprocessor-Based Sensors</i> (see References).	

C.6.2.3 Start verification command (aV!)

The response to a Start Verification command can include hardware diagnostics, but like the aI! command, the response is not standardized.

Command: aV!

Response: *atttn*<CR> <LF>

a = sensor address

ttn = time, in seconds, until verification information is available

n = the number of values to be returned when one or more subsequent D! commands are issued

C.6.2.4 Address query command (?!)

Command ?! requests the address of the connected sensor. The sensor replies to the query with the address, *a*. This command should only be used with one sensor on the SDI-12 bus at a time.

C.6.2.5 Change address command (aAb!)

Multiple SDI-12 sensors can connect to a single SDI-12 terminal on a data logger. Each device on a single terminal must have a unique address.

A sensor address is changed with command **aAb!**, where *a* is the current address and *b* is the new address. For example, to change an address from 0 to 2, the command is **0A2!**. The sensor responds with the new address *b*, which in this case is 2.

NOTE:

Only one sensor should be connected to a particular terminal at a time when changing addresses.

C.6.2.6 Start measurement commands (aM!)

A measurement is initiated with the **M!** command. The response to each command has the form *attn*<CR><LF>, where

a = sensor address

ttt = time, in seconds, until measurement data is available. When the data is ready, the sensor notifies the data logger, and the data logger begins issuing **D** commands.

n = the number of values returned when one or more subsequent **D** commands are issued. For the **aM!** command, *n* is an integer from 0 to 9.

When the **aM!** is issued, the data logger pauses its operation and waits until either it receives the data from the sensor or the time, *ttt*, expires. Depending on the scan interval of the data logger program and the response time of the sensor, this may cause skipped scans to occur. In this case make sure your scan interval is longer than the longest measurement time (*ttt*).

0M!	The data logger makes a request to sensor 0 to start a measurement.
00352<CR><LF>	Sensor 0 immediately indicates that it will return two values within the next 35 seconds.

Table C-6: Example aM! sequence	
0<CR><LF>	Within 35 seconds, sensor 0 indicates that it has completed the measurement by sending a service request to the data logger.
OD0!	The data logger immediately issues the first D command to collect data from the sensor.
0+.859+3.54<CR><LF>	The sensor immediately responds with the sensor address and the two values.

C.6.2.7 Start concurrent measurement commands (aC!)

A concurrent measurement (aC!) command follows the same pattern as the aM! command with the exception that it does not require the data logger to pause its operation, and other SDI-12 sensors may take measurements at the same time. The sensor will not issue a service request to notify the data logger that the measurement is complete. The data logger will issue the aD0! command during the next scan after the measurement time reported by the sensor has expired. To use this command, the scan interval should be 10 seconds or less. The response to each command has the form *atttn<CR><LF>*, where

a = the sensor address

ttt = time, in seconds, until the measurement data is available

nn = the number of values to be returned when one or more subsequent D commands are issued.

See the following example. A data logger has three sensors wired into terminal C1. The sensors are addresses X, Y, and Z. The data logger will issue the following commands and receive the following responses:

Table C-7: Example aC! sequence	
XC!	The data logger makes a request to sensor X to start a concurrent measurement.
X03005<CR><LF>	Sensor X immediately indicates that it will have 5 (05) values ready for collection within the next 30 (030) seconds.
YC!	The data logger makes a request to sensor Y to start a concurrent measurement.

Table C-7: Example aC! sequence	
Y04006<CR> <LF>	Sensor Y immediately indicates that it will have 6 (06) values ready for collection within the next 40 (040) seconds.
ZC!	The data logger makes a request to sensor Z to start a concurrent measurement.
Z02010<CR> <LF>	Sensor Z immediately indicates that it will have 10 values ready for collection within the next 20 (020) seconds.
ZD0!	After 20 seconds have passed, the data logger starts the process of collecting the data by issuing the first D command to sensor Z.
Z+1+2+3+4+5+6+7+8+9+10<CR> <LF>	Sensor Z immediately responds with the sensor address and the 10 values.
XD0!	10 seconds later, after a total of 30 seconds have passed, the data logger starts the process of collecting data from sensor X by issuing the first D command.
X+1+2+3+4+5<CR> <LF>	The sensor immediately responds with the sensor address and the 5 values.
YD0!	Ten seconds later, after a total of 40 seconds have passed, the data logger starts the process of collecting data from sensor Y by issuing the first D command.
Y+1+2+3+4+5+6<CR> <LF>	The sensor immediately responds with the sensor address and the 6 values.

C.6.2.8 Start measurement commands with cyclic redundancy check (aMC! and aCC!)

Error checking is done by using measurement commands with cyclic redundancy checks (aMC! or aCC!). This is most commonly implemented when long cable lengths or electronic noise may impact measurement transmission to the data logger. When these commands are used, the data returned in response to **D** or **R** commands must have a cyclic redundancy check (CRC) code

appended to it. The CRC code is a 16-bit value encoded within 3 characters appended before the <CR><LF>. This code is not returned in the data table but checked by the data logger as it comes. The code returned is based on the SDI-12 protocol. See the SDI-12 communication specification for version 1.4 available at www.sdi-12.org to learn more about how the CRC code is developed.

C.6.2.9 Stopping a measurement command

A measurement command (M!) is stopped if it detects a break signal before the measurement is complete. A break signal is sent by the data logger before most commands.

A concurrent measurement command (C!) is aborted when another valid command is sent to the sensor before the measurement time has elapsed.

C.6.2.10 Send data command (aD0! ... aD9!)

The Send Data command requests data from the sensor. It is issued automatically with every type of measurement command (aM!, aMC!, aC!, aCC!). When the measurement command is aM! or aMC!, the data logger issues the aD0! command once a service request has been received from the sensor or the reported time has expired. When the data logger is issuing concurrent commands (aC! or aCC!), the Send Data command is issued after the required time has elapsed (no service request will be sent by the sensor). In transparent mode (see [SDI-12 transparent mode](#) [p. 51]), the user asserts this command to obtain data.

Depending on the type of data returned and the number of values a sensor returns, the data logger may need to issue aD0! up to aD9! to retrieve all data. A sensor may return up to 35 characters of data in response to a D command that follows an M! or MC! command. A sensor may return up to 75 characters of data in response to a D command that follows a C! or CC! command. Data values are separated by plus or minus signs.

Command: aD0! (aD1! ... aD9!)

Response: a<values><CR><LF> or a<values><CRC><CR><LF>

where:

a = the sensor address

<values> = values returned with a polarity sign (+ or -)

<CR><LF> = terminates the response

<CRC> = 16-bit CRC code appended if data was requested with aMC! or aCC!.

C.6.2.11 Continuous measurement command (aR0! ... aR9!)

Sensors that are able to continuously monitor the phenomena to be measured can be read directly with the **R** commands (**R0!** ... **R9!**). The response to the **R** commands mirrors the Send Data command (**aD0!**). A maximum of 75 characters can be returned in the *<values>* part of the response to the **R** command.

C.6.2.12 Extended commands

Many sensors support extended SDI-12 commands. An extended command is specific to a make of sensor and tells the sensor to perform a specific task. They have the following structure. Responses vary from unit to unit. See [CS700H extended commands](#) (p. 19) for specifics.

Command: **aXNNNN!**

The command will start with the sensor address (**a**), followed by an **X**, then a set of optional letters, and terminate with an exclamation point.

Response: *a<optional values><CR><LF>*

The response will start with the sensor address and end with a carriage return/line feed.

C.6.3 SDI-12 transparent mode

System operators can manually interrogate and enter settings in probes using transparent mode. Transparent mode is useful in troubleshooting SDI-12 systems because it allows direct communication with probes. Data logger security may need to be unlocked before activating the transparent mode.

Transparent mode is entered while the computer is communicating with the data logger through a terminal emulator program. It is accessed through Campbell Scientific data logger support software or other terminal emulator programs. Data logger keyboards and displays cannot be used.

The terminal emulator is accessed by navigating to the **Tools** list in *PC400* or the **Datalogger** list in the **Connect** screen of *LoggerNet*.

Watch [videos/sdi12-sensors-transparent-mode](#)  from our website.

Data loggers from other manufacturers will also have a transparent mode. Refer to those manuals on how to use their transparent mode.

The following examples show how to enter transparent mode and change the SDI-12 address of an SDI-12 sensor. The steps shown in [Changing an SDI-12 address](#) (p. 52) are used with most Campbell Scientific data loggers.

C.6.3.1 Changing an SDI-12 address

This example was done with a CR1000X, but the steps are only slightly different for CR6, CR3000, CR800-series, CR300-series, CR1000 data loggers.

1. Connect an SDI-12 sensor to the CR1000X.
2. Open *Device Configuration* utility.
3. Under **Device Type**, type the data logger model and double-click on the model type. This example uses a CR1000X directly connected to the computer USB port.
4. Select the correct **Communication Port** and click **Connect**.

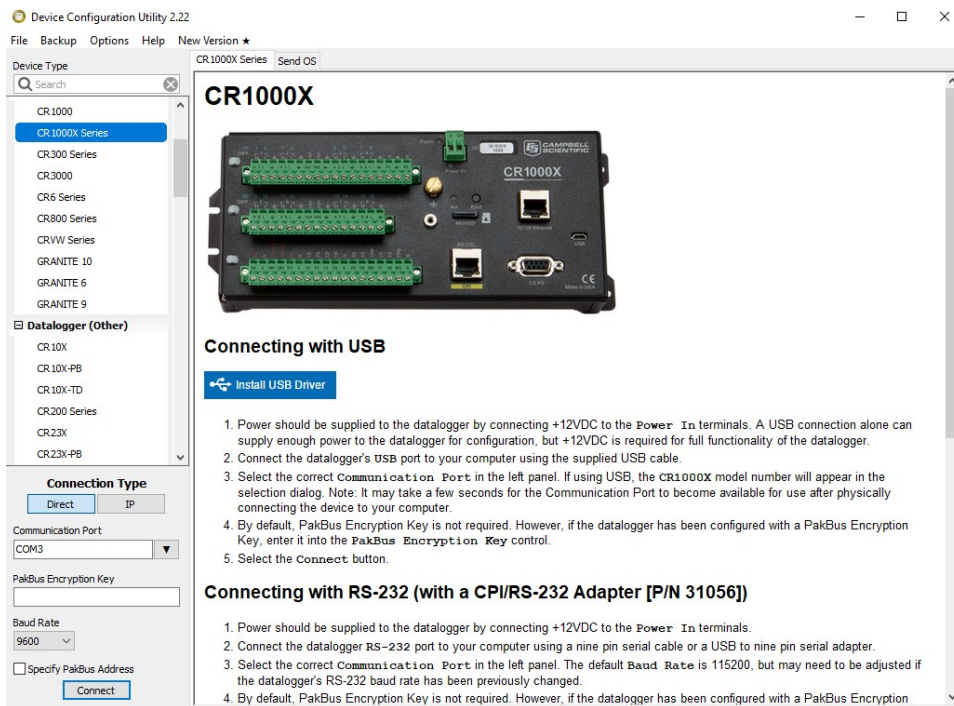

5. Click the **Terminal** tab.

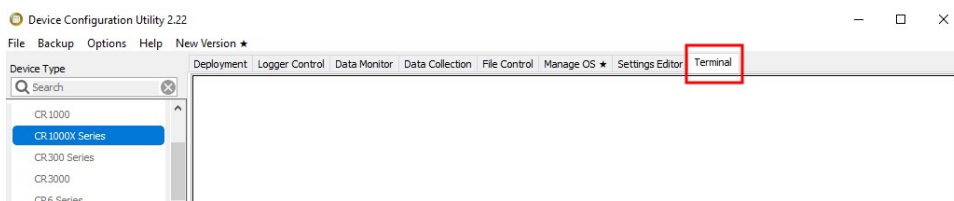

6. Select **All Caps Mode**.

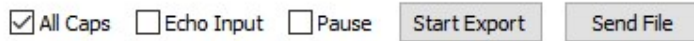

7. Press Enter until the data logger responds with the data logger (**CR1000X>**) prompt.

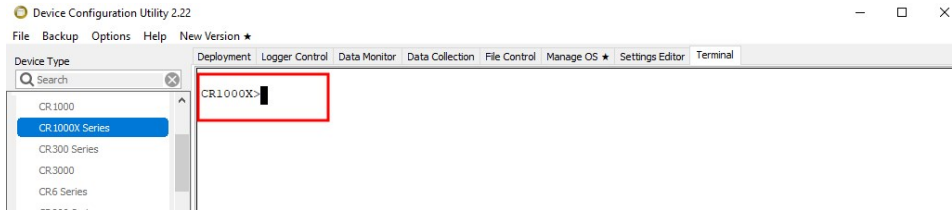

8. Type **SDI12** and press Enter.
9. At the **Select SDI12 Port** prompt, type the number corresponding to the control port where the sensor is connected and press Enter. In this example the sensor is connected to C3. The response **Entering SDI12 Terminal** indicates that the sensor is ready to accept SDI-12 commands.

```
CR1000X>
CR1000X>SDI12
1: C1
2: C3
3: C5
4: C7
Select SDI12 Port: 2
```

10. To query the sensor for its current SDI-12 address, type **?!** and press Enter. The sensor responds with its SDI-12 address. If no characters are typed within 60 seconds, the mode is exited. In that case, simply type **SDI12** again, press Enter, and type the correct control port number when prompted.

```
?!
0
```

11. To change the SDI-12 address, type **aAb!**, where **a** is the current address from the previous step and **b** is the new address. Press **Enter**. The sensor changes its address and responds with the new address. In the following example, the sensor address is changed from 0 to B.

```
SDI12
SDI12>0AB!B
```

12. To exit SDI-12 transparent mode, click **Close Terminal**.

NOTE:

The transparent mode for the CR6, CR3000, CR800-series, CR300-series, and CR1000 data loggers is similar to that shown for the CR1000X.

C.6.4 References

SDI-12 Support Group. SDI-12: A Serial-Digital Interface Standard for Microprocessor-Based Sensors – Version 1.4. River Heights, UT: SDI-12 Support Group, 2017. <https://sdi-12.org/specification> .

Appendix D. Phoenix Contact power supply specifications

The Phoenix Contact power supply is used for the –AC option for the CS700H only.

Model Name: Quint-PS/1AC/24DC/10

Input data

Nominal input voltage: 100 to 240 VAC
AC input voltage range: 85 to 264 VAC
Short-term input voltage: 300 VAC
AC frequency range: 45 to 65 Hz
Name of protection: Transient surge protection
Protective circuit/component: Varistor

Output data

Nominal output voltage: 24 VDC \pm 1%
Setting range of the output voltage: 18 to 29.5 VDC (>24 V constant capacity)
Output current: 10 A (–25 to 60 °C, U_{OUT} = 24 VDC)
15 A (with POWER BOOST, –25 to 40 °C permanently, U_{OUT} = 24 VDC)
Derating: From 60 to 70 °C: 2.5% per Kelvin
Connection in parallel: Yes, for redundancy and increased capacity
Connection in series: Yes
Maximum power dissipation idling: 7 W
Power loss nominal load max.: 18 W

General data

Width: 60 mm (2.4 in)
Height: 130 mm (5.1 in)
Depth: 125 mm (4.9 in)

Weight:	1.1 kg (2.4 lb)
Efficiency:	> 92.5% (for 230 VAC and nominal values)
Ambient temperature (operation):	-25 to 70 °C (> 60 °C derating)
Ambient temperature (storage/transport):	-40 to 85 °C
Max. permissible relative humidity (operation):	95% (at 25 °C, no condensation)

NOTE:

Additional specifications are provided in Phoenix Contact's manual for the Quint-PS/1AC/24DC/10.

Limited warranty

Covered equipment is warranted/guaranteed against defects in materials and workmanship under normal use and service for the period listed on your sales invoice or the product order information web page. The covered period begins on the date of shipment unless otherwise specified. For a repair to be covered under warranty, the following criteria must be met:

1. There must be a defect in materials or workmanship that affects form, fit, or function of the device.
2. The defect cannot be the result of misuse.
3. The defect must have occurred within a specified period of time; and
4. The determination must be made by a qualified technician at a Campbell Scientific Service Center/ repair facility.

The following is not covered:

1. Equipment which has been modified or altered in any way without the written permission of Campbell Scientific.
2. Batteries; and
3. Any equipment which has been subjected to misuse, neglect, acts of God or damage in transit.

Campbell Scientific regional offices handle repairs for customers within their territories. Please see the back page of the manual for a list of [regional offices](#) or visit www.campbellsci.com/contact  to determine which Campbell Scientific office serves your country. For directions on how to return equipment, see [Assistance](#).

Other manufacturer's products, that are resold by Campbell Scientific, are warranted only to the limits extended by the original manufacturer.

CAMPBELL SCIENTIFIC EXPRESSLY DISCLAIMS AND EXCLUDES ANY IMPLIED WARRANTIES OF MERCHANTABILITY OR FITNESS FOR A PARTICULAR PURPOSE. Campbell Scientific hereby disclaims, to the fullest extent allowed by applicable law, any and all warranties and conditions with respect to the products, whether express, implied, or statutory, other than those expressly provided herein.

Campbell Scientific will, as a default, return warranted equipment by surface carrier prepaid. However, the method of return shipment is at Campbell Scientific's sole discretion. Campbell Scientific will not reimburse the claimant for costs incurred in removing and/or reinstalling equipment. This warranty and the Company's obligation thereunder is in lieu of all other

warranties, expressed or implied, including those of suitability and fitness for a particular purpose. Campbell Scientific is not liable for consequential damage.

In the event of any conflict or inconsistency between the provisions of this Warranty and the provisions of Campbell Scientific's Terms, the provisions of Campbell Scientific's Terms shall prevail. Furthermore, Campbell Scientific's Terms are hereby incorporated by reference into this Warranty. To view Terms and conditions that apply to Campbell Scientific, Logan, UT, USA, see [Terms and Conditions](#) . To view terms and conditions that apply to Campbell Scientific offices outside of the United States, contact the [regional office](#) that serves your country.

Assistance

Products may not be returned without prior authorization. Please inform us before returning equipment and obtain a **return material authorization (RMA) number** whether the repair is under warranty/guarantee or not. See [Limited warranty](#) for information on covered equipment.

Campbell Scientific regional offices handle repairs for customers within their territories. Please see the back page of the manual for a list of [regional offices](#) or visit www.campbellsci.com/contact  to determine which Campbell Scientific office serves your country.

When returning equipment, a RMA number must be clearly marked on the outside of the package. Please state the faults as clearly as possible. Quotations for repairs can be given on request.

It is the policy of Campbell Scientific to protect the health of its employees and provide a safe working environment. In support of this policy, when equipment is returned to Campbell Scientific, Logan, UT, USA, it is mandatory that a "[Declaration of Hazardous Material and Decontamination](#)" form be received before the return can be processed. If the form is not received within 5 working days of product receipt or is incomplete, the product will be returned to the customer at the customer's expense. For details on decontamination standards specific to your country, please reach out to your [regional Campbell Scientific](#) office.

NOTE:

All goods that cross trade boundaries may be subject to some form of fee (customs clearance, duties or import tax). Also, some regional offices require a purchase order upfront if a product is out of the warranty period. Please contact your [regional Campbell Scientific](#) office for details.

Safety

DANGER — MANY HAZARDS ARE ASSOCIATED WITH INSTALLING, USING, MAINTAINING, AND WORKING ON OR AROUND TRIPODS, TOWERS, AND ANY ATTACHMENTS TO TRIPODS AND TOWERS SUCH AS SENSORS, CROSSARMS, ENCLOSURES, ANTENNAS, ETC. FAILURE TO PROPERLY AND COMPLETELY ASSEMBLE, INSTALL, OPERATE, USE, AND MAINTAIN TRIPODS, TOWERS, AND ATTACHMENTS, AND FAILURE TO HEED WARNINGS, INCREASES THE RISK OF DEATH, ACCIDENT, SERIOUS INJURY, PROPERTY DAMAGE, AND PRODUCT FAILURE. TAKE ALL REASONABLE PRECAUTIONS TO AVOID THESE HAZARDS. CHECK WITH YOUR ORGANIZATION'S SAFETY COORDINATOR (OR POLICY) FOR PROCEDURES AND REQUIRED PROTECTIVE EQUIPMENT PRIOR TO PERFORMING ANY WORK.

Use tripods, towers, and attachments to tripods and towers only for purposes for which they are designed. Do not exceed design limits. Be familiar and comply with all instructions provided in product manuals. Manuals are available at www.campbellsci.com You are responsible for conformance with governing codes and regulations, including safety regulations, and the integrity and location of structures or land to which towers, tripods, and any attachments are attached. Installation sites should be evaluated and approved by a qualified engineer. If questions or concerns arise regarding installation, use, or maintenance of tripods, towers, attachments, or electrical connections, consult with a licensed and qualified engineer or electrician.

General

- Protect from over-voltage.
- Protect electrical equipment from water.
- Protect from electrostatic discharge (ESD).
- Protect from lightning.
- Prior to performing site or installation work, obtain required approvals and permits. Comply with all governing structure-height regulations, such as those of the FAA in the USA.
- Use only qualified personnel for installation, use, and maintenance of tripods and towers, and any attachments to tripods and towers. The use of licensed and qualified contractors is highly recommended.
- Read all applicable instructions carefully and understand procedures thoroughly before beginning work.
- Wear a hardhat and eye protection, and take other appropriate safety precautions while working on or around tripods and towers.
- Do not climb tripods or towers at any time, and prohibit climbing by other persons. Take reasonable precautions to secure tripod and tower sites from trespassers.
- Use only manufacturer recommended parts, materials, and tools.

Utility and Electrical

- You can be killed or sustain serious bodily injury if the tripod, tower, or attachments you are installing, constructing, using, or maintaining, or a tool, stake, or anchor, come in contact with overhead or underground utility lines.
- Maintain a distance of at least one-and-one-half times structure height, 6 meters (20 feet), or the distance required by applicable law, whichever is greater, between overhead utility lines and the structure (tripod, tower, attachments, or tools).
- Prior to performing site or installation work, inform all utility companies and have all underground utilities marked.
- Comply with all electrical codes. Electrical equipment and related grounding devices should be installed by a licensed and qualified electrician.
- Only use power sources approved for use in the country of installation to power Campbell Scientific devices.

Elevated Work and Weather

- Exercise extreme caution when performing elevated work.
- Use appropriate equipment and safety practices.
- During installation and maintenance, keep tower and tripod sites clear of un-trained or non-essential personnel. Take precautions to prevent elevated tools and objects from dropping.
- Do not perform any work in inclement weather, including wind, rain, snow, lightning, etc.

Internal Battery

- Be aware of fire, explosion, and severe-burn hazards.
- Misuse or improper installation of the internal lithium battery can cause severe injury.

- Do not recharge, disassemble, heat above 100 °C (212 °F), solder directly to the cell, incinerate, or expose contents to water. Dispose of spent batteries properly.

Use and disposal of batteries

- Where batteries need to be transported to the installation site, ensure they are packed to prevent the battery terminals shorting which could cause a fire or explosion. Especially in the case of lithium batteries, ensure they are packed and transported in a way that complies with local shipping regulations and the safety requirements of the carriers involved.
- When installing the batteries follow the installation instructions very carefully. This is to avoid risk of damage to the equipment caused by installing the wrong type of battery or reverse connections.
- When disposing of used batteries, it is still important to avoid the risk of shorting. Do not dispose of the batteries in a fire as there is risk of explosion and leakage of harmful chemicals into the environment. Batteries should be disposed of at registered recycling facilities.

Avoiding unnecessary exposure to radio transmitter radiation

- Where the equipment includes a radio transmitter, precautions should be taken to avoid unnecessary exposure to radiation from the antenna. The degree of caution required varies with the power of the transmitter, but as a rule it is best to avoid getting closer to the antenna than 20 cm (8 inches) when the antenna is active. In particular keep your head away from the antenna. For higher power radios (in excess of 1 W ERP) turn the radio off when servicing the system, unless the antenna is installed away from the station, e.g. it is mounted above the system on an arm or pole.

Maintenance

- Periodically (at least yearly) check for wear and damage, including corrosion, stress cracks, frayed cables, loose cable clamps, cable tightness, etc. and take necessary corrective actions.
- Periodically (at least yearly) check electrical ground connections.

WHILE EVERY ATTEMPT IS MADE TO EMBODY THE HIGHEST DEGREE OF SAFETY IN ALL CAMPBELL SCIENTIFIC PRODUCTS, THE CUSTOMER ASSUMES ALL RISK FROM ANY INJURY RESULTING FROM IMPROPER INSTALLATION, USE, OR MAINTENANCE OF TRIPODS, TOWERS, OR ATTACHMENTS TO TRIPODS AND TOWERS SUCH AS SENSORS, CROSSARMS, ENCLOSURES, ANTENNAS, ETC.

Global Sales and Support Network

A worldwide network to help meet your needs



- Corporate Headquarters
- Regional Office



Campbell Scientific Regional Offices

Australia

Location: Garbutt, QLD Australia
Phone: 61.7.4401.7700
Email: info@campbellsci.com.au
Website: www.campbellsci.com.au

Brazil

Location: São Paulo, SP Brazil
Phone: 11.3732.3399
Email: vendas@campbellsci.com.br
Website: www.campbellsci.com.br

Canada

Location: Edmonton, AB Canada
Phone: 780.454.2505
Email: dataloggers@campbellsci.ca
Website: www.campbellsci.ca

China

Location: Beijing, P. R. China
Phone: 86.10.6561.0080
Email: info@campbellsci.com.cn
Website: www.campbellsci.com.cn

Costa Rica

Location: San Pedro, Costa Rica
Phone: 506.2280.1564
Email: info@campbellsci.cc
Website: www.campbellsci.cc

France

Location: Montrouge, France
Phone: 0033.0.1.56.45.15.20
Email: info@campbellsci.fr
Website: www.campbellsci.fr

Germany

Location: Bremen, Germany
Phone: 49.0.421.460974.0
Email: info@campbellsci.de
Website: www.campbellsci.de

India

Location: New Delhi, DL India
Phone: 91.11.46500481.482
Email: info@campbellsci.in
Website: www.campbellsci.in

South Africa

Location: Stellenbosch, South Africa
Phone: 27.21.8809960
Email: sales@campbellsci.co.za
Website: www.campbellsci.co.za

Spain

Location: Barcelona, Spain
Phone: 34.93.2323938
Email: info@campbellsci.es
Website: www.campbellsci.es

Thailand

Location: Bangkok, Thailand
Phone: 66.2.719.3399
Email: info@campbellsci.asia
Website: www.campbellsci.asia

UK

Location: Shepshed, Loughborough, UK
Phone: 44.0.1509.601141
Email: sales@campbellsci.co.uk
Website: www.campbellsci.co.uk

USA

Location: Logan, UT USA
Phone: 435.227.9120
Email: info@campbellsci.com
Website: www.campbellsci.com