

SkyVUE™ PRO (CS135)

LIDAR Ceilometer

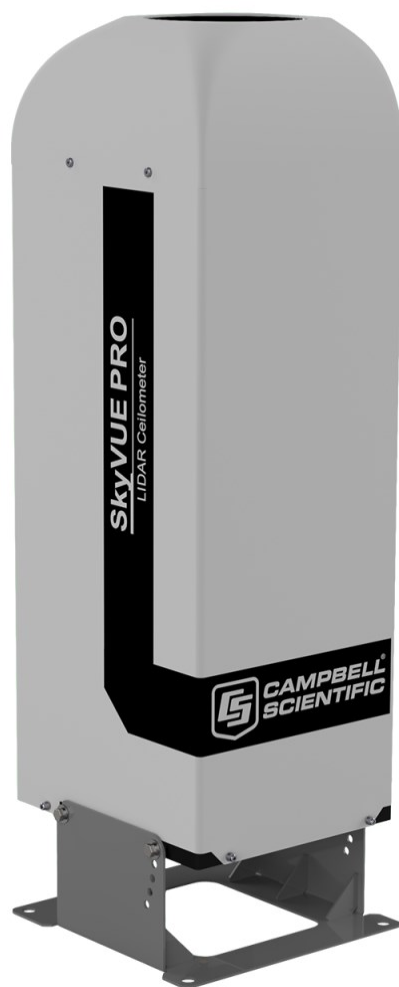

Table of contents

1. General information	1
1.1 Packing list	1
1.2 General safety	1
1.3 Sensor unit safety	2
1.4 Laser safety	2
1.5 Electrical safety	3
2. Product overview	4
2.1 Introduction	5
2.1.1 Cloud height detection	6
2.1.2 Sky condition	6
2.1.3 Backscatter profile reporting	7
2.1.4 Mixing layer height	7
2.2 Optical measurement	8
2.2.1 Optical arrangement	8
2.3 Internal monitoring	8
2.4 Specifications	9
2.4.1 Measurement specifications	9
2.4.2 Mechanical specifications	9
2.4.3 Electrical specifications	10
2.4.4 Optical specifications	12
2.4.5 Environmental specifications	12
2.4.6 Communications specifications	12
3. Initial preparation and checks	13
4. Installation	14
4.1 Location and orientation	14
4.2 Grounding	15
4.3 Mounting the SkyVUE PRO	15
4.4 Tilt angle	16
4.5 Connectors and wiring	17
4.5.1 Base connectors	18
4.5.2 Wiring using supplied Campbell Scientific cables	19

4.5.2.1 Power connections	20
4.5.2.2 Communications connections	21
4.5.3 USB connection	22
4.5.4 SDI-12 connection	22
4.6 Connecting the back-up battery	22
4.6.1 Removing the cover	23
4.6.2 Removing the enclosure lid	23
4.7 Bird spike kit	24
4.8 Storage information	26
5. Operation	27
5.1 Terminal mode	27
5.1.1 Entering/exiting the SkyVUE PRO terminal mode	27
5.1.2 Terminal mode commands general	28
5.1.3 Terminal mode command examples	29
5.1.4 Application command message types	44
5.1.5 MCFG command message types	46
5.1.6 Measurement and message intervals	47
5.1.7 Status command	49
5.1.8 Message polling	58
5.1.9 Loading a new operating system (OS)	59
5.1.10 Stratocumulus backscatter calibration	62
5.1.11 CRC-16 codes on terminal commands	64
5.1.12 Service command	65
5.1.13 Locked features	66
5.2 Restoring factory defaults	66
5.3 LED indicator	67
6. Messages	68
6.1 Data messages general	68
6.2 Checksums used in SkyVUE PRO messages	68
6.3 CS messages	69
6.3.1 MESSAGE 001 (no profile, no sky condition)	69
6.3.2 MESSAGE 002 (Profile, no sky condition)	73
6.3.3 MESSAGE 003 (no profile, sky condition)	76
6.3.4 MESSAGE 004 (profile, sky condition) — default message	78
6.3.5 MESSAGE 005 (no profile, sky condition, mixing layer heights)	82
6.3.6 MESSAGE 006 (profile, sky condition, mixing layer heights)	85

6.4 CL31 messages	89
6.4.1 MESSAGES 101 - 106, (CL31 MESSAGE 1)	89
6.4.2 MESSAGE 005 (no profile, sky condition, mixing layer heights)	90
6.4.3 MESSAGES 107 - 112, CL31 Message 2	94
6.5 CT25K messages	98
6.5.1 MESSAGE 113, CT25K Data Message No. 1	98
6.5.2 MESSAGE 114, CT25K Data Message No. 6	101
7. Maintenance	103
7.1 General	103
7.2 Cleaning	103
7.3 Removing the cover	104
7.4 Removing the enclosure lid	105
7.5 Diagnostic LED indicators within the enclosure	105
7.6 Electrical safety testing	107
Appendix A. Measurement of the attenuated backscatter profile	108
A.1 Initial measurement	108
A.2 Backscatter onset height detection	108
A.3 Produce attenuated backscatter output message	109
Appendix B. Cloud height calculation	110
Appendix C. Sky condition algorithm description	111
Appendix D. Replacing the SkyVUE PRO PSU	113
Appendix E. SkyVUE PRO Laser/APD module replacement	115
Appendix F. SkyVUE PRO TOP board replacement	118
Appendix G. Self-diagnostic information	124
List of figures	
FIGURE 2-1. Principle of operation	8
FIGURE 2-2. SkyVUE PRO dimensions	10
FIGURE 2-3. PSU types	11
FIGURE 4-1. Mounting base footprint	16
FIGURE 4-2. Setting the tilt angle	17
FIGURE 4-3. Connector layout	18
FIGURE 4-4. Cable connections	21
FIGURE 4-5. USB port	22

FIGURE 4-6. Connecting battery	22
FIGURE 4-7. Removing the cover	23
FIGURE 4-8. Removing the enclosure lid	24
FIGURE 4-9. Ceilometer bird spike kit installed	25
FIGURE 4-10. Preparing the SkyVUE PRO for installing the bird spikes	25
FIGURE 4-11. Attaching bird spikes to the SkyVUE PRO cowl	26
FIGURE 5-1. Restoring factory defaults	67
FIGURE 5-2. LED indicator	67
FIGURE 7-1. Removing the cover	104
FIGURE 7-2. Removing the enclosure lid	105
FIGURE 7-3. Diagnostic LED indicators	106

List of tables

Table 1-1: Packing list	1
Table 4-1: Function of the connector pins for the mains connector	18
Table 4-2: Function of the connector pins for the blower/heater connector	19
Table 4-3: Function of the connector pins for the communications connector	19
Table 5-1: Summary of the terminal mode commands available	30
Table 5-2: Summary of applications and applied settings for SkyVUE PRO	45
Table 5-3: Summary of message ID and descriptions	46
Table 6-1: Most significant alarm word for CS messages	70
Table 6-2: Middle alarm word for CS messages	71
Table 6-3: Least significant alarm word for CS messages	72
Table 6-4: Most significant alarm word for CS31 messages	91
Table 6-5: Middle alarm word for CS31 messages	92
Table 6-6: Least significant alarm word for CS31 messages	92
Table 6-7: Most significant alarm word for CT25K messages	99
Table 6-8: Second alarm word for CT25K messages	100

1. General information

1.1 Packing list	1
1.2 General safety	1
1.3 Sensor unit safety	2
1.4 Laser safety	2
1.5 Electrical safety	3

1.1 Packing list

The following table lists the products shipped with the SkyVUE PRO.

Description	Quantity
Ceilometer	1
Power supply cable	1
Data cable	1
Bolt, sleeve anchor	4
Cable, USB type A plug to type B plug, 2 m	1
4 mm Allen key	1
Calibration plate	1

1.2 General safety

This manual provides important safety considerations for the installation, operation and maintenance of the SkyVUE™PRO. These safety considerations are classified into three levels:

WARNING:

Warnings alert the installer or user to serious hazards. Ignoring these warnings could result in injury or death and/or irrevocable damage to the sensor unit.

CAUTION:

Cautions warn of potential hazards. Ignoring these cautions could result in the sensor being damaged and data being lost.

NOTE:

Notes highlight useful information in the installation, use and maintenance of this product. These should be followed carefully in order to gain the maximum benefit from the use of this product.

1.3 Sensor unit safety

The SkyVUE PRO sensor has been checked for safety before leaving the factory and contains no internally replaceable or modifiable parts.

WARNING:

Do not modify the SkyVUE PRO unit. Such modifications will lead to damage of the unit and could expose users to dangerous light levels and voltages.

WARNING:

Do not attempt to repair the SkyVUE PRO unit without consulting Campbell Scientific.

CAUTION:

Ensure that the correct voltage supply is provided to the sensor.

1.4 Laser safety

The SkyVUE PRO sensor incorporates an InGaAs laser diode which is rated as a class 3B device. This is an embedded laser where the output from the sensor unit, through the optics, is minimized to class 1M. This classification indicates that viewing of the beam with the naked eye is safe but looking directly into the beam with optical instruments, e.g. binoculars can be dangerous.

From the laser head the output has the following characteristics:

Maximum average power: 15.0 mW (through 50 mm)

Maximum pulse energy: 1500 nJ (through 50 mm)

Pulse duration: 100 ns

Pulse frequency: 10 kHz

Wavelength: 912 nm \pm 5 nm

Tested to: EN 60825-1:2014

Half angle divergence: 0.44 mrad

The sensor is marked with the following warning information:

INVISIBLE LASER RADIATION
DO NOT VIEW DIRECTLY WITH OPTICAL INSTRUMENTS
CLASS 1M LASER PRODUCT

WARNING:

Removing the laser module with the power applied to the SkyVUE PRO may expose the user to hazardous class 3B laser radiation.

No attempt should be made to operate the laser module outside of the housing.

WARNING:

Annually, check that the laser warning label on the sensor is still visible and can be clearly read.

When installing the sensor, avoid pointing the laser housing towards areas where binoculars are in common use.

WARNING:

Use of controls or adjustments or performance of procedures other than those specified herein may result in hazardous radiation exposure.

1.5 Electrical safety

Because the sensor is powered from potentially hazardous mains voltages, the power-supply should be wired only by personnel qualified to install electrical equipment. For permanent outside installations, this usually requires a certified electrician who is also familiar with local electrical and safety legislation. Some general guidance is given in [Connectors and wiring](#) (p. 17), but the responsibility for the installation lies with the installer.

The unit is tested for electrical safety before dispatch but may need subsequent testing according to local practice.

NOTE:

The unit should only be serviced by trained personnel.

WARNING:

Removal of electronic module covers or connectors while the unit is powered will expose the operator to potentially hazardous voltages and risk damage to the sensor.

The SkyVUE PRO has electrical and laser warning labels on the exterior and interior of the unit. It is recommended that the hood and access panel door are not opened in conditions of rain, hail or snow.

Isolate the sensor before removing internal components, including the cover to the avalanche photodiode (APD) module. Only trained personnel should disassemble the instrument.

Mains connectors are shrouded to prevent touching of the contacts. The mains supply should be isolated when connecting and disconnecting the cables to the sensor.

Where an isolator switch is fitted, this shall be a two-pole isolator, located as near to the sensor as possible.

The SkyVUE PRO must be properly grounded by a licensed and qualified electrician to protect against voltage leakage shock risk ([Grounding](#) (p. 15)).

Campbell Scientific recommends that RCD protection units be used with all sensors. See [Power connections](#) (p. 20) for further information.

Mains powered heaters are enclosed to prevent contact.

CAUTION:

When powered, the heaters may operate automatically and without warning. They may remain hot when not powered. Follow the isolation precautions, to avoid shock and burn hazards.

The sealed battery has cables and protected connectors to prevent shorts. Avoid shorting the battery to protect it from damage and to avoid burns to personnel through contact with hot surfaces.

2. Product overview

2.1 Introduction	5
2.2 Optical measurement	8
2.3 Internal monitoring	8
2.4 Specifications	9

2.1 Introduction

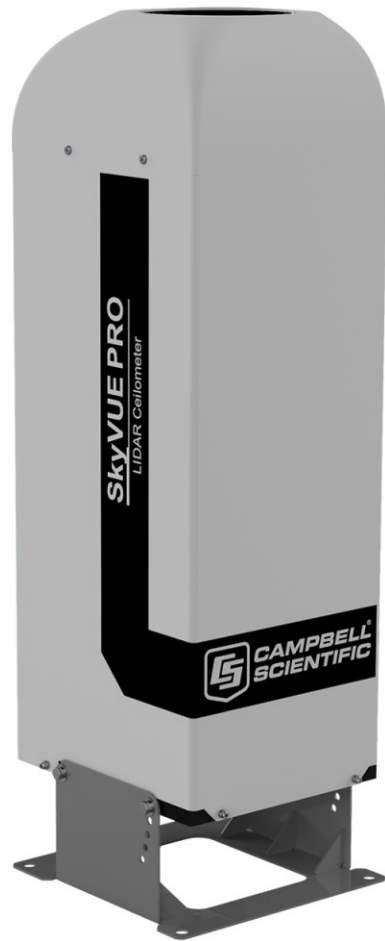

The SkyVUE PRO is a light detection and ranging (LIDAR) ceilometer that emits short pulses of near infrared light into the atmosphere from a semiconductor laser. The pulses of infrared light are scattered back by aerosols including cloud droplets. The time between transmission of the pulse and the return signal gives the range, and therefore height, of the scattering aerosols. The variation in the strength of the back-scattered light signal with height gives a profile of scatter coefficients and allows identification of cloud bases. If significant scattering is detected without a defined cloud base, then a vertical visibility can be calculated.

The control system of the SkyVUE PRO is divided into three modules, DSP, TOP and PSU as follows:

DSP (Digital Signal Processor) is the main data processing and communications unit of the SkyVUE PRO. It hosts two separate time keeping circuits that are cross checked. An alarm is triggered if the circuits disagree.

TOP (top of the unit) provides safety shutdown features such as over and under laser output level. It also contains the calibration circuitry and dirty windows system.

PSU (Power Supply Unit) controls the power supply including battery charging and deep discharge protection.

The SkyVUE PRO has a rugged environmental enclosure that protects the instrument from the harshest conditions and will measure the atmosphere with high stability and repeatability.

2.1.1 Cloud height detection

A scatter profile is measured as described in [Measurement of the attenuated backscatter profile](#) (p. 108).

Cloud height detection is carried out as described in [Cloud height calculation](#) (p. 110). Up to four cloud heights can be detected.

If clouds are not detected, the SkyVUE PRO will give one of these reports:

- No significant backscatter.
- Full obscuration determined but no cloud base detected. This is reported if the criteria for detecting cloud base is not met but the integrated scattering coefficient reaches the limit of vertical visibility below a set height limit. The default value is 2000 m (6560 ft) but can be changed by the user. The height at which this occurs is given as vertical visibility.
- Some obscuration detected but determined to be transparent is reported if scattering is detected but no cloud is detected and the calculated vertical visibility exceeds a set height limit.

If no cloud is detected but significant scattering is detected below 50 m (160 ft), then vertical visibility is set to 0.

2.1.2 Sky condition

Sky condition is an assessment of cloud cover measured in units of eighths known as oktas. The number of oktas is the density of cloud in eighths of that layer. The SkyVUE PRO can report up to five layers of cloud when reporting sky condition. The algorithm used in the SkyVUE PRO follows guidance in the *ICAO 9837, Manual on Automatic Meteorological Observing Systems at Aerodromes*.

Sky condition is not an instantaneous measurement. It is based on cloud data for the previous 30 minutes, with cloud detection in the previous 10 minutes given an extra weighting. Therefore, sky condition is not available until sufficient data has been collected. See [Sky condition algorithm description](#) (p. 111) for more detail.

2.1.3 Backscatter profile reporting

Several possible data messages give the two-way attenuated backscatter profile. This consists of 2048 groups of five-character values (10,240 characters in total). Each character is 8 bits long and therefore each 5 figure group is 40 bits. They are given as signed two complement integers and numbers greater than $2^{39}-1$ represent negative integers.

Therefore, each group actually represents negative, a value between -2^{39} to $+(2^{39}-1)$, rather than 0 to $(2^{40}-1)$, which would be the case for unsigned, positive, 40-bit integers.

Apply the following two-stage process to correct the decimal value:

1. Convert the hexadecimal characters to a decimal number.
2. If the number resulting from this conversion is greater than 1048575, subtract 1,099,511,627,776, which is 2^{40} .

To use this backscatter coefficient in units of $\text{sr}^{-1} \text{m}^{-1}$, the sensor multiplies the calculated decimal number by a factor of 10^{-8} . The values are scaled by the **Attenuated_SCALE** parameter, see [Table 5-1](#) (p. 30).

NOTE:

The last two values of the profile will always be zero. They are beyond the 10 km (32,800 ft) range of the instrument.

NOTE:

The profile is not corrected for tilt angle even if cloud heights are corrected.

2.1.4 Mixing layer height

A Mixing Layer Height measurement option is available. This retrieves the height of the mixed aerosol layer by applying the gradient method to the ceilometer backscatter signal. This approach, based on the operational algorithm used by KNMI, searches for the drop in backscatter associated with the transition from boundary layer aerosols to free troposphere. Since the signals measured depend on the type and amount of aerosol present as well as the background light level, the accuracy of the method varies, and therefore a quality factor is assigned that indicates the confidence in the reported layer height. The module is also capable of indicating the top of residual layers and aerosol layers aloft. To activate this option please contact Campbell Scientific.

This is a guide to how well the mixing layer is defined on a scale 1 to 3 (3 is best). It is determined by the magnitude of the difference between the average backscatter over a distance below the MLH and the average backscatter over a distance above the MLH.

Haij, M.J. de, H. Klein Baltink and W.M.F. Wauben: Continuous mixing layer height determination using the LD-40 ceilometer: a feasibility study, Scientific Report WR 2007-01, KNMI, De Bilt, 2007."

2.2 Optical measurement

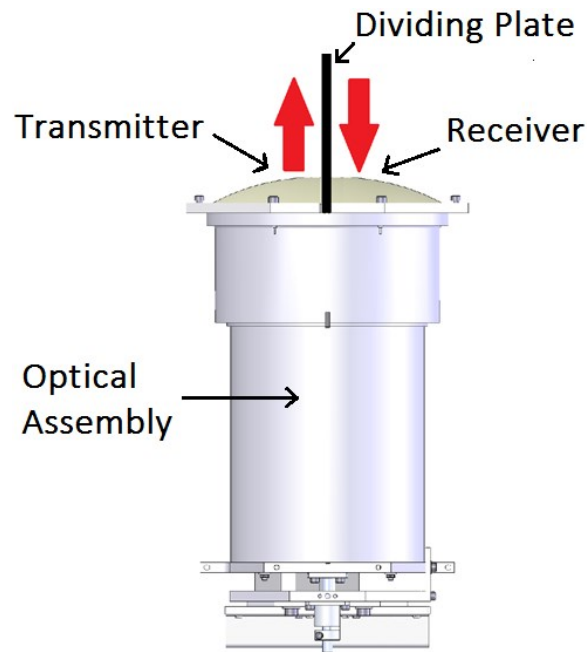

FIGURE 2-1. Principle of operation

2.2.1 Optical arrangement

The SkyVUE PRO uses a single split lens design that increases optical signal-to-noise ratio, while maintaining Class 1M eye safety by integrating larger optics into a compact package (see [FIGURE 2-1](#) (p. 8)). Half of the lens is used by the transmitter, and the other half is used by the receiver. This design provides an alternative to traditional two lens or common-optics designs. The optical isolation of traditional biaxial systems is maintained to increase detector sensitivity, while the low overlap onset height of common-optics systems is incorporated to allow measurements at close ranges.

2.3 Internal monitoring

The SkyVUE PRO monitors window contamination, key voltages and currents, internal temperature and relative humidity, and other parameters relevant to its performance. Data

messages (see [Operation](#) (p. 27)) include this information allowing remote diagnosis of the SkyVUE PRO condition. In addition, a special status message can be polled.

2.4 Specifications

2.4.1 Measurement specifications	9
2.4.2 Mechanical specifications	9
2.4.3 Electrical specifications	10
2.4.4 Optical specifications	12
2.4.5 Environmental specifications	12
2.4.6 Communications specifications	12

2.4.1 Measurement specifications

Maximum reporting range:	10 km (32800 ft)
Minimum reporting resolution:	5 m (15 ft)
Hard target range accuracy:	$\pm 0.25\% \pm 4.6$ m (15 ft)
Reporting cycle:	2 to 600 s
Cloud layers reported:	Up to four layers reported

2.4.2 Mechanical specifications

Height:	1000 mm (39.3 in)
Width:	327 mm (12.8 in)
Depth:	281 mm (11 in)
Total weight:	33 kg (72 lb), excluding cables
Shipping weight:	58 kg (128 lb)

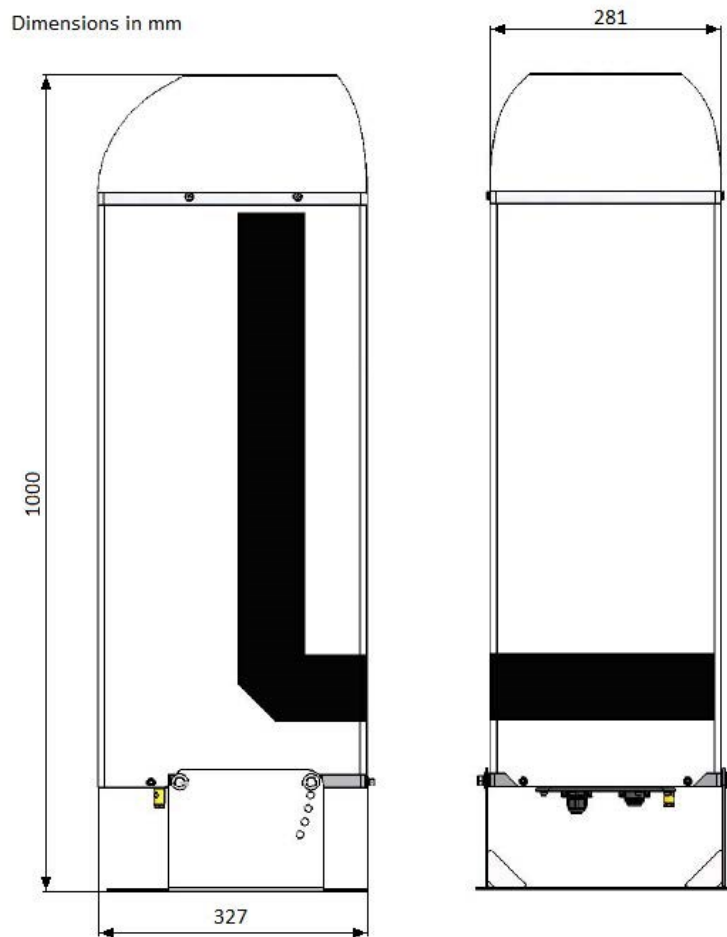

FIGURE 2-2. SkyVUE PRO dimensions

2.4.3 Electrical specifications

Power required:	Nominal 115 VAC (106 to 137 VAC) or nominal 230 VAC (216 to 253 VAC) (automatic selection), 47 to 63 Hz, 470 W total maximum
Heater:	
Hood heater:	270 W, maximum
Internal heater:	120 W, maximum
Supply voltage:	Specified at time of order
Fuses:	Current models use HBC SA(T); older models used the following:
AUX fuse:	HBC 5A (T)

PSU fuse: HBC 500 mA (T)

All fuses are 5 x 20 mm slow blow (T) and are the same for both 115 VAC and 230 VAC.

CAUTION:

The fuse values used must match the design of power supply unit.

Battery:

Internal 12 V, 7 Ah sealed lead-acid battery provides 2 hour measurement without the blower/heater. The power supply is equipped with a system to prevent deep discharge of the battery.

The SkyVUE PRO uses positive temperature coefficient (PTC) heaters within its design. These heaters are self-regulating, simplifying the internal design of the sensor and improving safety. Due to the nature of these devices, the SkyVUE PRO takes a higher current during start up. The SkyVUE PRO takes up to 1 KW for the first few seconds of operation, dropping off quickly to its normal operating power after a minute. In cold environments, the power consumption of the SkyVUE PRO may be as high as 470 W. In warmer environments, it may be as low as 200 W.

The heaters are resistive, which is advantageous when connected to generators or when current consumption is important.

Older PSU design

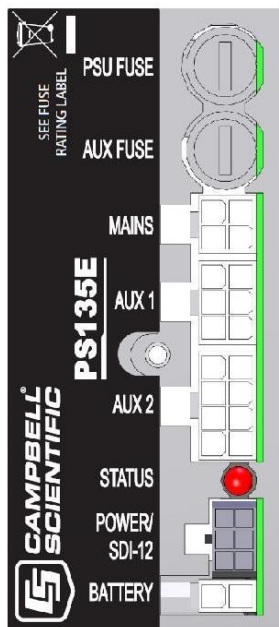

Fuse 500mA
5 x 20mm
Slow blow (T)

Fuse 5A
5 x 20mm
Slow blow (T)

New PSU design

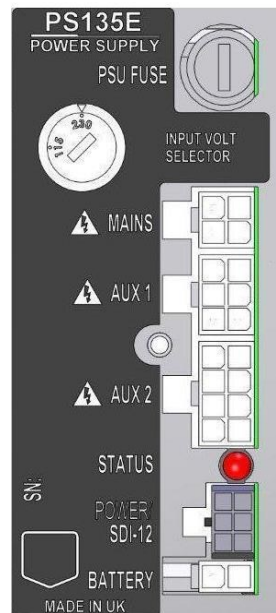

Fuse 5A
5 x 20mm
Slow blow (T)

FIGURE 2-3. PSU types

2.4.4 Optical specifications

Pulse duration:	100 ns
Pulse frequency:	10 kHz
Wavelength:	912 ± 5 nm
Half-angle laser divergence:	0.35 mrad
Field of view:	1.5 mrad
Laser lifetime:	10 years typical
Eye safety class:	1M

2.4.5 Environmental specifications

Standard operating temperature range:	-40 to 60 °C (excluding battery)
Battery temperature range:	-20 to 50 °C (alternative battery types available)
Relative humidity range:	0 to 100%
IP rating:	IP 66
Maximum wind speed:	55 m/s

2.4.6 Communications specifications

Supported serial settings:	8 bits, no parity, 1 stop bit (default)	
	7 bits, even parity, 1 stop bit	
	7 bits, odd parity, 1 stop bit	
Supported data rates:	300 baud	19200 baud
	600 baud	38400 baud
	1200 baud	57600 baud
	2400 baud	76800 baud
	4800 baud	115200 baud (default)
	9600 baud	
Supported standards:	RS-232 (default)	
	RS-485 full duplex	
	RS-485 half duplex	

Signal voltage levels:

	Minimum value	Nominal value	Maximum value
RS-232 communications			
RS-232 input threshold low	0.8 V	1.5 V	–
RS-232 input threshold high	–	2.0 V	2.4 V
RS-232 input absolute maximum	–15 V	–	+15 V
RS-232 input resistance	12 K Ω	–	–
RS-232 output voltage low	–	–	0.4 V
RS-232 output voltage high (into 3 K Ω)	4.4 V	–	–
RS-485/422 communications			
RS-485/422 input threshold voltage	–0.2 V	–	+0.2 V
RS-485/422 output (unloaded)	–	–	5V
RS-485/422 output (load 50 Ω)	2 V	–	–
Maximum voltage at any terminal	–7 V	–	+7 V

USB Service Port USB1.1 and 2.0 compatible, fixed 115200 baud.

3. Initial preparation and checks

The following steps will provide basic familiarization with the SkyVUE PRO and perform basic functionality checks. To do these, remove the cover and enclosure lid and connect the battery (see [Connecting the back-up battery](#) (p. 22)). Connect the hood heater plug ([FIGURE 4-3](#) (p. 18))

WARNING:

The laser begins operating as soon as the battery is connected. Do not point the laser in any direction where it could be viewed with magnifying optics.

The green LED visible from above should flash once every 10 seconds (see [FIGURE 5-2](#) (p. 67)).

Connect the SkyVUE PRO **USB** port (see [FIGURE 4-5](#) (p. 22)) to a computer and use a terminal emulation program to set to 115200 baud, 8N1 bits/parity settings.

The computer should identify the USB connection and allocate a port number. Enter the port setting in the terminal emulator program. Older computer operating systems may need upgrading or additional software.

The SkyVUE PRO will output message type 004 (default) every 30 seconds (see [CS messages](#) (p. 69)).

Use the **open 0** command to open the terminal mode. You should now see the prompt **CS135>**. Type **Status** to see the sensor status information described in [Status command](#) (p. 49). If using date/time information, checked it since the date/time can drift up to ± 14 seconds per day.

If the unit has been in storage or transit for more than a few months, the clock battery may be discharged. However, it will charge from the back-up battery or mains power.

Use the **Close** command to exit the terminal mode. It will close automatically after 10 minutes of inactivity.

If you are not installing the unit and connecting mains power, you should disconnect the battery to avoid it being discharged.

4. Installation

4.1 Location and orientation	14
4.2 Grounding	15
4.3 Mounting the SkyVUE PRO	15
4.4 Tilt angle	16
4.5 Connectors and wiring	17
4.6 Connecting the back-up battery	22
4.7 Bird spike kit	24
4.8 Storage information	26

4.1 Location and orientation

The SkyVUE PRO measures environmental variables and is designed to be located in harsh weather conditions. However, there are a few considerations to take into account if accurate and representative data from a site are to be obtained.

To reduce the service frequency with the unit, place the SkyVUE PRO away from sources of contamination. More regular maintenance will be required when the instrument is placed in areas where contamination is unavoidable or where measurements may be safety related.

Take care that the orientation allows tilting in whatever direction is desired.

WARNING:

If installing at an airport, check and follow local guidance for allowed locations for a non-frangible object 1 m (3.2 ft) tall. Please contact Campbell Scientific if frangible fittings are required.

4.2 Grounding

The SkyVUE PRO must be properly grounded by taking a ground wire with a minimum cross sectional area of 16 mm² (0.62 in) and maximum length of 10 m (32.8 ft) from the brass grounding boss to an adequate grounding point. [FIGURE 2-2](#) (p. 10) shows the location of the grounding boss.

4.3 Mounting the SkyVUE PRO

Mount the SkyVUE PRO by bolting to a firm, level foundation. When bolting down, ensure the SkyVUE PRO can tilt in all desired directions. [FIGURE 4-1](#) (p. 16) shows the mounting footprint. If a suitable surface does not already exist, construct a concrete foundation, at least 600 mm (23.6 in) square and 600 mm (23.6 in) deep, by using the following procedure:

1. Drill four 12 mm (0.47 in) diameter holes using the mount base as a template (see [FIGURE 4-1](#) (p. 16)) to a depth of 77 mm (3.03 in).
2. Clean the holes of all debris.
3. Place washers and nuts on the ends of the wedge anchors supplied (to protect the threads during installation).
4. Hammer the wedge anchors into the holes until the start of the threads are below the surface.
5. Tighten the nuts until about 25 mm (0.98 in) of thread protrudes above the surface.
6. Remove the washers and nuts from the protruding length screw, then lower the SkyVUE PRO into place.
7. Secure the SkyVUE PRO with the washers and nuts.

8. If the surface is not level and flat, add washers under the base on one or more of the foundation screws.

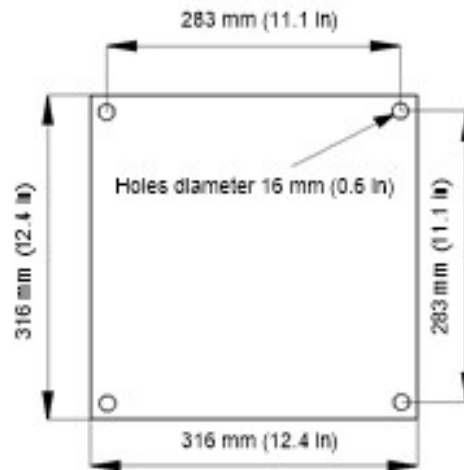

FIGURE 4-1. Mounting base footprint

4.4 Tilt angle

The SkyVUE PRO can be tilted 6°, 12°, 18° or 24° from vertical. In tropical regions, tilting the sensor north in the northern hemisphere and south in the southern hemisphere can prevent the sun from shining directly into the sensor. The tilt angle also can reduce problems caused by direct specular reflections from ice crystals, and prevent rain or snow from falling onto the window. To adjust the tilt angle, remove the bolts shown in [FIGURE 4-2](#) (p. 17), move the SkyVUE PRO to the required tilt angle, and replace the bolts.

The SkyVUE PRO has tilt sensors in both axes to compensate the cloud height when the base is not level. Set or disable cloud height compensation by using the **UNITS** command ([Terminal mode command examples](#) (p. 29)). This feature is useful for mobile or marine applications. Profile data is NOT compensated but tilt angles are included in data messages.

NOTE:

Increasing the tilt angle beyond 24° can cause significant errors in vertical visibility measurements if scatter coefficients vary significantly with height.

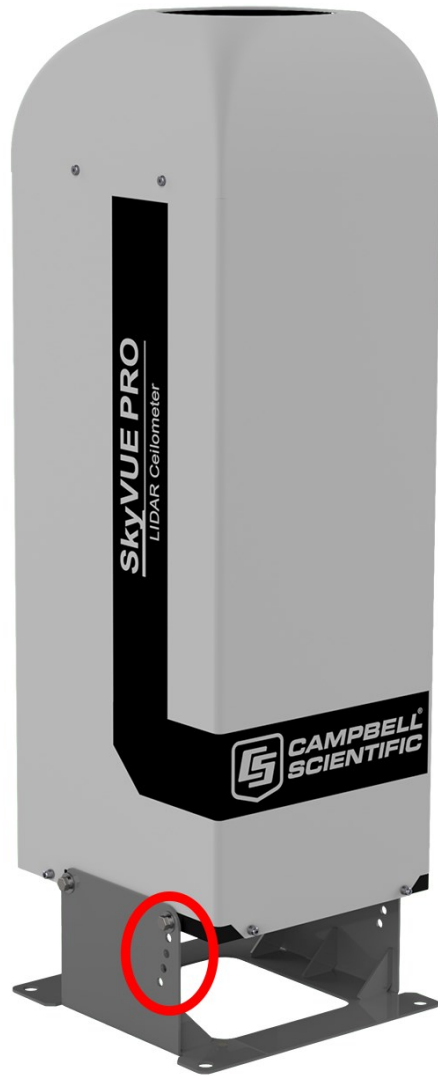

FIGURE 4-2. Setting the tilt angle

4.5 Connectors and wiring

4.5.1 Base connectors	18
4.5.2 Wiring using supplied Campbell Scientific cables	19
4.5.3 USB connection	22
4.5.4 SDI-12 connection	22

4.5.1 Base connectors

The SkyVUE PRO has three connectors on its base. One connector is for communications; another connector provides power to the unit and the last connector takes power from the unit to the hood heater and blower.

NOTE:

Tilting the unit provides better access to these connectors.

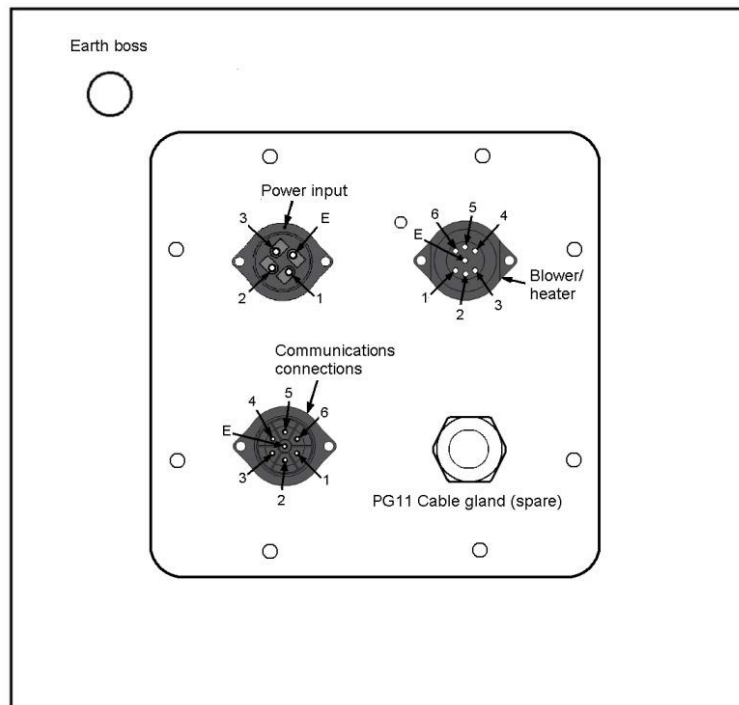

FIGURE 4-3. Connector layout

The function of the connector pins is shown in [Table 4-1](#) (p. 18), [Table 4-2](#) (p. 19), and [Table 4-3](#) (p. 19).

Pin	Function	Color of supplied cable cores
1	Live	Brown
2	Not connected	NA
3	Neutral	Blue
4	Earth	Green/yellow

Table 4-2: Function of the connector pins for the blower/heater connector

Pin	Function	Color of supplied cable cores
1	Neutral	Black (1)
2	Fan + 12 VDC	Black (2)
3	Thermistor	Black (3)
4	Thermistor (0 V)	Black (4)
5	Switched 230/115 VAC	Black (5)
6	Fan 0 V	Black (6)
E	Earth	Green/yellow

Table 4-3: Function of the connector pins for the communications connector

Pin on connector on SkyVUE PRO	Color of supplied cable cores	9-pin D connector	RS-232	RS-485 half duplex	RS-485 full duplex/ RS-422
1	Red	8	CTS (DCE) output	B/D+	Y/TXD non-inverting
2	Yellow	7	RTS (DCE) input		B/RXD non-inverting
3	Green	5	Gnd		
4	Black			Gnd	Gnd
5	White	2	RXD (DCE) output	A/D-	Z/TXD inverting
6	Blue	3	TXD (DCE) input		A/RXD inverting
E	Screen				

4.5.2 Wiring using supplied Campbell Scientific cables

Two cables are supplied, each 10 m (32.8 ft) long. One is for the mains power supply and the other is for communications.

WARNING:

Incorrectly wiring the power cable can cause irrevocable damage to the unit and can cause serious injury or death.

WARNING:

The power cable must not be carrying mains voltage when it is being connected or disconnected.

4.5.2.1 Power connections

The following is a guide for wiring and installing a permanent power supply.

As the sensor is used outside, a qualified electrician should install the power cables. Please check local safety regulations.

Ensure that the termination type, cable type, and cable run of the mains power source complies with local regulations and fits the installation requirements.

The power source needs to provide the correct voltage, frequency, and current in excess of the power requirement of the system.

Voltage requirements: 106 to 137 VAC or 216 to 253 VAC (check power supply switch and fuses match the nominal 115/230V AC supply)

Current requirements: 5 A

Input frequency: 47 to 63 Hz

The power source needs fuses with ratings of 5 A or larger and a slow-blow design. Cable extensions or replacement cables should be capable of carrying current in excess of that fuse rating.

Include a two-pole isolator as close to the sensor as is possible.

The power cable needs three conductors (live, neutral, and a protective earth), normally with IEC wiring colors to match those used.

The equipment requires the connection of earth ground using the earth wire of the power connector/cable or via the earth stud on the sensor base. Ensure the earth connection at the power source is suitable for this purpose.

This equipment also requires correct connection of the live and neutral conductors — make sure these are identified and wired correctly at the power source.

Normally, fit the power source with its own or system wide earth leakage breaker (also known as an RCD).

For short term testing of the sensor, fit the power cable with a suitable plug can be fitted to the end of the power cable and the sensor plugged into a standard mains supply capable of providing 5 A at the rated voltage. If this is done, the earth wire of the sensor must be connected to a suitable protective earth point.

For DC operation, the SkyVUE PRO requires a 10 to 40 VDC supply capable of 1 A at 12 VDC or 0.5 A at 24 VDC.

4.5.2.2 Communications connections

The communications cable terminates at one end with a removable 9-pin, D-connector (DB9). The D-connector connects directly to a computer or data logger such as the Campbell Scientific CR1000X using a suitable interconnecting cable such as the SC110. FIGURE 4-4 (p. 21). The connector can easily be removed for direct connection to screw terminals.

See www.campbellsci.com/downloads/skyvue-example-programs for CRBasic programs that connect the SkyVUE PRO to a Campbell Scientific data logger.

CAUTION:

The supplied cable is not recommended for lengths greater than 10 m (32.8 ft). Longer RS-485 cables should incorporate twisted pairs. Contact Campbell Scientific if needing longer cable lengths.

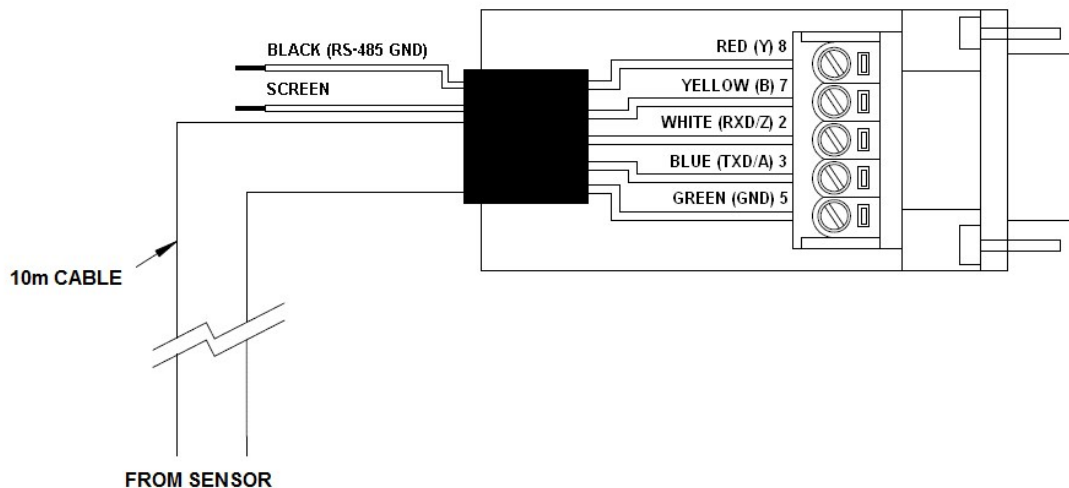

FIGURE 4-4. Cable connections

Tilting the unit (FIGURE 4-2 (p. 17)) will make wiring easier.

4.5.3 USB connection

The USB port provided inside the enclosure is for on-site maintenance. It supports communication of commands to the SkyVUE PRO and responses in the same form as the main serial port, except the baud rate is fixed at 115200 (see [FIGURE 4-5](#) (p. 22)).

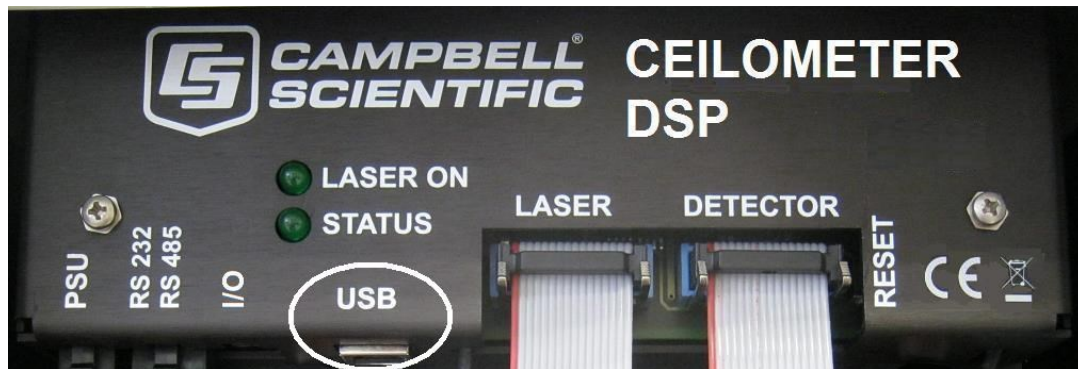

FIGURE 4-5. USB port

4.5.4 SDI-12 connection

An SDI-12 port is present but is only used for factory setting of the instrument.

4.6 Connecting the back-up battery

The SkyVUE PRO is shipped with the back-up battery disconnected and includes desiccant used for transport. Before using the unit, remove the cover and enclosure lid, connect the internal battery ([FIGURE 4-6](#) (p. 22), remove the desiccant, and replace the cover and enclosure lid.

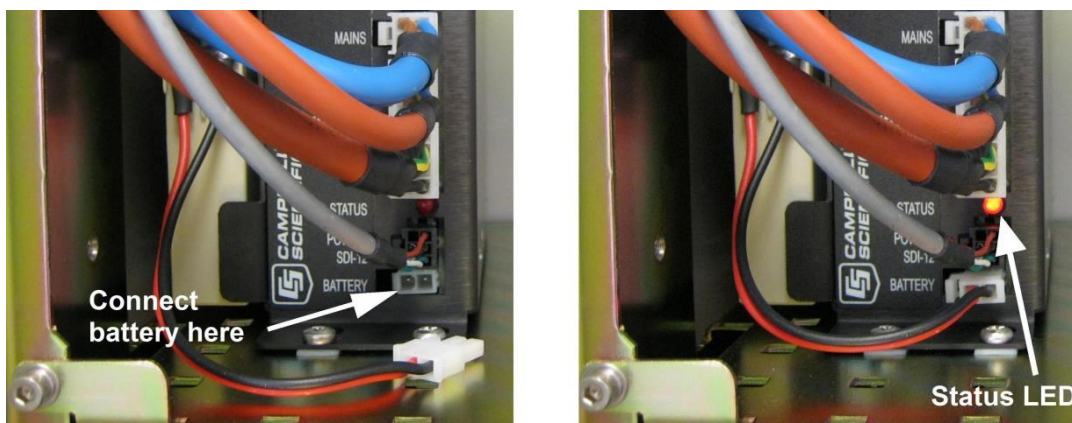

FIGURE 4-6. Connecting battery

4.6.1 Removing the cover

1. Remove four screws (FIGURE 4-7 (p. 23)).

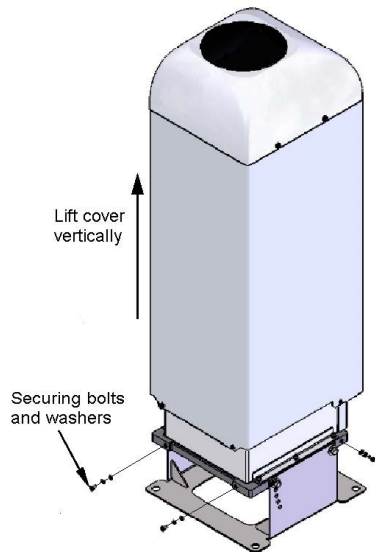

FIGURE 4-7. Removing the cover

2. Lift the cover off the base.

CAUTION:

The cover contains a flying lead used to take power to the hood heater and blower. Be careful not to trap and damage this when lifting the cover clear.

4.6.2 Removing the enclosure lid

1. Remove the four screws (FIGURE 4-8 (p. 24))
2. Pull the enclosure lid away from the electronic unit.

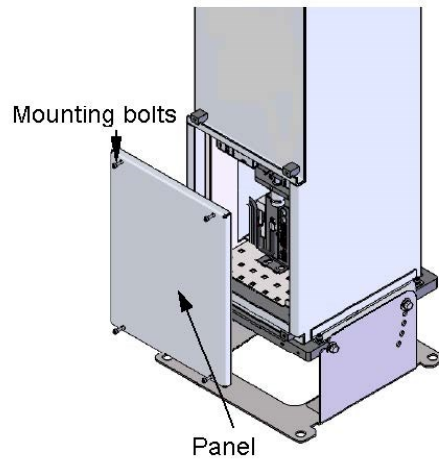

FIGURE 4-8. Removing the enclosure lid

WARNING:

Opening the access door **MUST** be carried out by a competent person, who has sufficient training, experience and knowledge both in electrical safety and the detail and operation of the sensor.

WARNING:

Removing the enclosure lid may expose hot surfaces.

4.7 Bird spike kit

The optional bird spike kit deters birds from sitting on the SkyVUE PRO. It includes four stainless-steel spikes with rounded ends and a small reel of stainless-steel wire. The following figure shows installed bird spikes.

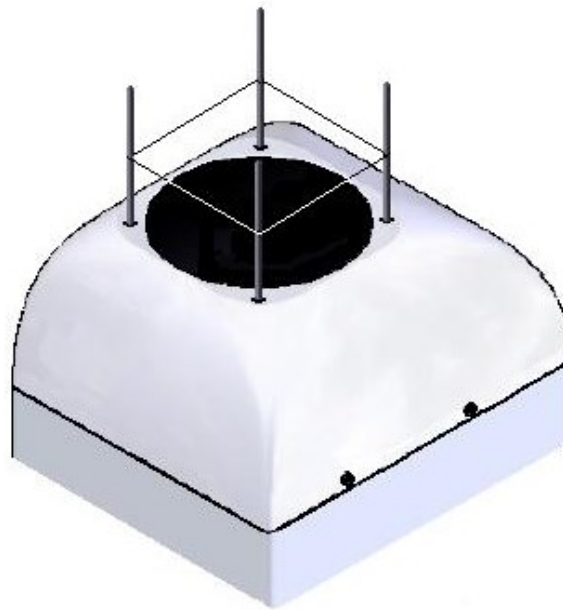

FIGURE 4-9. Ceilometer bird spike kit installed

To install the bird spikes, remove the cowl and blanking plugs from the cowl (FIGURE 4-10 (p. 25)). If the SkyVUE PRO is an older unit without pre-existing holes, then drill four holes each 4.5 mm (0.17 in) diameter, evenly spaced around the aperture and 10 mm (0.39 in) in from the edge. For each hole, place a nut and washer then thread the spike into the hole. Tighten the nuts and washers (see FIGURE 4-11 (p. 26)). Replace the cowl on the SkyVUE PRO.

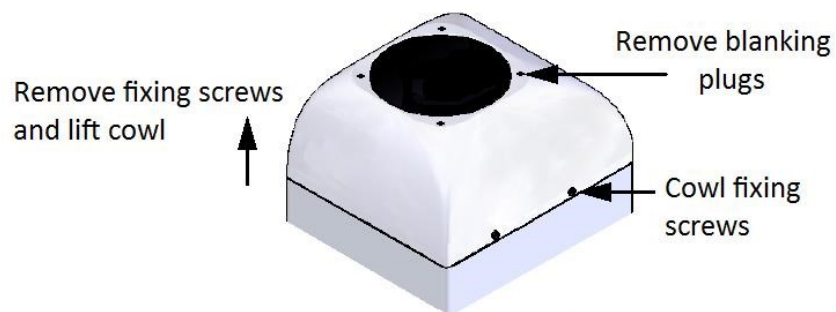

FIGURE 4-10. Preparing the SkyVUE PRO for installing the bird spikes



FIGURE 4-11. Attaching bird spikes to the SkyVUE PRO cowl

Wrap the stainless steel wire around each spike using the grooves in the spike then wrap it back on itself.

CAUTION:

Do not tighten the wire too much as it may pull the spikes inwards and obscure the field of view of the SkyVUE PRO optics.

Only use one strand of wire to reduce the possibility of water drops being collected.

Check the wire during maintenance and replace if necessary.

4.8 Storage information

Store the SkyVUE PRO in a dry place at -40 to 70 °C, preferably with the enclosures securely fastened. Protect the optics from possible accidental damage. Disconnect the back-up battery when storing the SkyVUE PRO.

NOTE:

If the battery remains connected during storage, the unit will be powered until the battery voltage falls below a shut-down threshold.

NOTE:

Storing the SkyVUE PRO below 0.0 °C will increase the start-up time by up to ten minutes. At -20 °C, the SkyVUE PRO will not achieve full accuracy for an hour.

NOTE:

Remove the battery if the SkyVUE PRO is to be stored outside the –20 to 50 °C temperature range.

5. Operation

5.1 Terminal mode	27
5.2 Restoring factory defaults	66
5.3 LED indicator	67

5.1 Terminal mode

5.1.1 Entering/exiting the SkyVUE PRO terminal mode	27
5.1.2 Terminal mode commands general	28
5.1.3 Terminal mode command examples	29
5.1.4 Application command message types	44
5.1.5 MCFG command message types	46
5.1.6 Measurement and message intervals	47
5.1.7 Status command	49
5.1.8 Message polling	58
5.1.9 Loading a new operating system (OS)	59
5.1.10 Stratocumulus backscatter calibration	62
5.1.11 CRC-16 codes on terminal commands	64
5.1.12 Service command	65
5.1.13 Locked features	66

5.1.1 Entering/exiting the SkyVUE PRO terminal mode

Use the **OPEN Sensor_ID Password** command to enter the menu system. The menu will time out and close automatically if not used for ten minutes.

Sensor_ID is the SkyVUE PRO identification, a single character 0-9, a-f, A-F case sensitive. Default is 0. Enter the password if using one. The following text should be displayed:

CS135>. The SkyVUE PRO is now ready for terminal mode commands.

The SkyVUE PRO commands are not case sensitive, but the parameters and password are case sensitive.

Example of the open command followed by the 0 parameter:

```
OPEN 0
```

Example of the open command with the password **Secret**:

```
OPEN 0 Secret
```

5.1.2 Terminal mode commands general

Table 5-1 (p. 30) provides a summary of the terminal mode commands.

To send commands that setup and control the SkyVUE PRO, use the terminal interface, data logger, or terminal emulators built into many Campbell Scientific software products.

NOTE:

To load an operating system (OS), you need a terminal emulator with XMODEM protocol such as Tera Term.

Use the following settings:

Setting	RS-232/422/485 interface (default)	USB service port
	RS-232 handshaking	
Baud rate	115200	115200
Data bits	8	8
Parity	none	none
Stop bits	1	1
Flow control	none	none

The baud rate of the SkyVUE PRO must match the port setting baud rate in the terminal emulator. The SkyVUE PRO should now be ready to accept commands.

NOTE:

Commands will always output all parameters on a new line after a CR LF (carriage return and line feed) and then the SkyVUE PRO prompt **CS135>**. If you only want to see parameter values without changing them, then enter the command without parameters. If a particular parameter did not need changing, then the parameter can be replaced with a comma (,). Back space will abort the command.

5.1.3 Terminal mode command examples

How to enter a command

Example 1

The following text shows an example of setting up the SkyVUE PRO serial port. This example sets the serial port to RS-232 hand shaking at 115200 bps, 8 data bits, no parity and if it was in RS-485 mode, then a 100 ms turn around delay.

```
serial 0 10 0 100
```

You could also type the following to obtain the same results as the RS-485 turn around delay is not needed:

```
serial 0 10 0
```

To change only the data baud rate, you can replace mode parameter, with a comma (,) as shown below.

```
serial , 10
```

Alternatively if you just wished to change the parity to 8-bits no parity, then type the following:

```
serial , , 0
```

You do not need to replace the remaining parameters with a comma (,); you only need to replace the ones up to the parameter you wish to edit.

NOTE:

Leave a space character between the command and the parameters as shown in the examples.

Example 2

Entering the **MCFG** command, as shown below, will set the sensor to send messages at 10 second intervals and to send one message only with the message number 112.

```
MCFG 10 112 0 0 0 0 (return)
```

The four zeros indicate that no other message outputs have been set. The **MCFG** command is described in [Table 5-1](#) (p. 30).

Table 5-1: Summary of the terminal mode commands available

Command	Parameter/ parameter block	Description
ALARMS	Angle	Angle is the threshold tilt angle of the sensor beyond which an alarm will be flagged. The settable range is 0 to 90.0 degrees tilt and the default is 45.0 degrees.
APPLICATION	Application_n	<p>Application_n selects pre-configured user settings optimized for a specific application. For the following values of n:</p> <ul style="list-style-type: none"> 0 = Help 10 = Aviation 20 = Research 40 = Meteorology 225 = User defaults <p>The default application for the SkyVUE PRO is 40, Meteorology. Settings adjusted by the APPLICATION command include settings in BS, MCFG, and UNITS.</p>
<p>BS (see Measurement and message intervals (p. 47) for more information on compatibility of different parameters)</p>	<p>Attenuated_SCALE, BS_Av_Time, Noise_Gate, Measurement_Period, Rolling_Average, Message_Interval BS_Temporal_Filter_Mode</p>	<p>Rules for BS command are:</p> <p>BS_Av_Time <= Measurement_Period-1s. Message_Interval must be a multiple of Measurement_Period.</p> <p>Attenuated_SCALE is the scalar for the attenuated backscatter percent. 0.001 to 100% (default 100%)</p> <p>BS_Av_Time is the backscatter average time in seconds. 1 to 30 (default 2).</p> <p>Note: Must not be greater than Measurement_Period – 1.0</p> <p>Noise_Gate controls the noise threshold applied to back-scatter.</p> <p>Noise_Gate = -1000, all backscatter range is corrected.</p>

Table 5-1: Summary of the terminal mode commands available

Command	Parameter/ parameter block	Description
		<p>Noise_Gate = 0.0 to 1000.0, standard deviation (default 2) for noise threshold. Only backscatter above this is range corrected.</p> <p>Measurement_Period = 0 or 2 to 600 seconds (default 10). If set to 0 and the SkyVUE PRO is polled, it will output the last measurement made. If between 2 and 600 seconds, the SkyVUE PRO continually outputs messages. For sky condition output, Campbell Scientific recommends setting the measurement_Period \leq 30 seconds. If a measurement_Period is greater than 30 seconds, the sky condition algorithm will be less able to resolve coverage for higher layers.</p> <p>Note: Must be a sub multiple of Message_Interval</p> <p>Rolling_Average = 1 to 29 (default 1). This is the number of measurement_periods to use in a rolling average of the backscatter.</p> <p>Message_Interval is the message interval in seconds. Range is 2 to 600 seconds (default 10 s); 0 gives polled messages.</p> <p>Note: Must be a multiple of Measurement_Period</p> <p>BS_Temporal_Filter_Mode allows the selection of backscatter filtering modes.</p> <p>0 = Averaging 1 = Median signal processing</p> <p>Default setting is 1, the median mode for aviation.</p>
CLOSE	No parameters	Closes the terminal interface to allow normal message output and saves new settings to flash non-volatile storage.

Table 5-1: Summary of the terminal mode commands available

Command	Parameter/ parameter block	Description
CLOUDMODE	C1oudMode_A	C1oudMode_A turns on a filter that reports the highest cloud during precipitation to avoid precipitation from being reported as low cloud. 0 = Filter Off 1 = Filter On (default). Reports the highest cloud during precipitation
DEFAULTS	No parameters	Loads factory defaults
GETUSER		Reads all user settings as a string of text. Parameters are read in the following order: user = text user vo1Ver = user volume version OS_VER = DSP OS version PsuOsVer = PSU OS version TopOsVer = TOP OS version Id = SkyVUE PRO ID Pw = SkyVUE PRO password terminalCrc = terminal crc mode terminalTimeout = terminal timeout unitsTiltMode = units and tilt mode hoodHBMode = hood heater / fan heater mode hoodHBTestInt = hood heater / blower test interval in hours battBoost_mV = boost voltage used for battery charging mV battCharge_mA = battery charge current mA psuPresent = PSU present switch hoodHBNormSpeed = fan voltage for normal speed mV

Table 5-1: Summary of the terminal mode commands available

Command	Parameter/ parameter block	Description
		<p>hoodHBHighSpeed = fan voltage for high speed mV</p> <p>hoodHBLowSpeed = fan voltage for low speed mV</p> <p>intHMode = internal heater mode</p> <p>message[0] = fields for message 0</p> <p>message[1] = fields for message 1</p> <p>message[2] = fields for message 2</p> <p>message[3] = fields for message 3</p> <p>message[4] = fields for message 4</p> <p>messagePeriod = output message period in seconds</p> <p>heightOffset= height offset meters</p> <p>bsAvTime= backscatter average time in seconds</p> <p>LaserMode = laser operation mode</p> <p>LaserPower = laser power</p> <p>LaserHeater = laser heater mode</p> <p>attenuatedSCALE = attenuated backscatter scaling factor</p> <p>LogInterval = debug logging interval</p> <p>measurementPeriod = measurement interval in seconds</p> <p>serMode = serial port mode</p> <p>baudSel = serial port baud rate mode</p> <p>dataParityStop = serial port parity mode</p> <p>rx2txTimeout = serial port RX to TX turnaround time</p> <p>snrMarginBoundary = onset of backscatter detection threshold</p>

Table 5-1: Summary of the terminal mode commands available

Command	Parameter/ parameter block	Description
		<p>snrMarginDetector = cloud detection threshold</p> <p>alphaGuessEnd = cloud alpha guess at boundary</p> <p>alphaMin = cloud detection alpha minimum</p> <p>Vc1d_D = cloud detection</p> <p>delta_Vc1d_D = cloud detection</p> <p>vis_Av_T = cloud detection</p> <p>alphaGuess = visibility initial alpha guess</p> <p>ratioLevel = visibility ratio</p> <p>alphaMin = visibility alpha minimum</p> <p>cap = visibility cap in meters</p> <p>tiltLimit = tilt limit in degrees used by alarms</p> <p>noiseGate = attenuated backscatter noise gate mode</p> <p>vvLimit_percent = sky condition report vertical visibility %</p> <p>alphaGuessStart= cloud detection alpha guess at lowest height bin</p> <p>dt = mixing layer height temporal filter in minutes</p> <p>dr = mixing layer height range filter in meters</p> <p>q1threshold = mixing layer height quality threshold 1</p> <p>q2threshold = mixing layer height quality threshold 2</p> <p>q3threshold = mixing layer height quality threshold 3</p> <p>stdWidth = mixing layer height standard deviation width meters</p> <p>c1oudMode = cloud detector mode parameter</p>

Table 5-1: Summary of the terminal mode commands available

Command	Parameter/ parameter block	Description
		<p>(03072019a)</p> <p>CRC = 4-digit character. CRC calculated from the u up to but not including the CRC using the standard CRC-16.</p> <p>Note: Many parameters are not adjusted. This command allows a reliable technique for copying full settings from one SkyVUE PRO to another with the SETUSER command.</p> <p>A typical response to the GETUSER command is:</p> <pre>>>>> COPY FROM START OF NEXT LINE >>>> user 7 007638-6da 106 510 0 , 0 10 2 0 1 14520 400 1 1000 1000 2000 0 1 0 0 0 10 0.000E+00 2.000E+00 1 1.000E+00 0 1.000E+00 0 10 1 0 10 0 100 4.000E+00 6.000E+00 2.000E-03 2.500E-04 1.000E+03 2.200E+01 4.800E+03 1.000E-01 9.000E-01 2.500E-04 2.000E+03 4.500E+01 2.000E+00 50 2.00E-03 3.000E+01 1.500E+02 1.800E+00 5.000E+00 1.000E+01 150 98b2 <<<<< TO START OF THIS LINE <<<<<</pre>
HEATERS	<p>Hood</p> <p>Internal</p> <p>Laser</p> <p>Test_interval</p>	<p>Sets or reads heater settings as follows:</p> <p>Hood = 0, Hood blower and heater OFF</p> <p>Hood = 1, Hood blower ON and heater OFF</p> <p>Hood = 2, Hood blower ON and heater ON</p> <p>Hood = 3, Hood blower and heater AUTO (default) – (see note (1) below).</p> <p>Internal = 0, Internal heater OFF</p> <p>Internal = 1, Internal heater ON</p> <p>Internal = 2, Internal heater AUTO (default)</p> <p>Laser = 0, laser heater off</p> <p>Laser = 1, laser heater on (default)</p>

Table 5-1: Summary of the terminal mode commands available

Command	Parameter/ parameter block	Description
		Test_interval = 1 to 168 hours (default 24 hours). Heater/Blower test interval
HELP	No parameters	Calls up a list of user commands with brief descriptions
HOFFSET	Height_offset	Height_offset is the offset to be added or subtracted in the range of ± 1000 m (± 3281 ft). Positive values are added to measured height and negative values are subtracted from measured height. The default is 0.
ID	Sensor_ID	Reads or sets the sensor ID, a single character, 0-9, a - z or A - Z, case sensitive. Default ID = 0. Note: Lower case letters are not allowed if using a CT25K message.
LASER	Laser Laser_Power	Laser = 0, laser off after power up (user must switch laser on) Laser = 1, laser on after power up (default) Laser_Power = 20% to 100%, default 100%
LASEROFF	No parameters	Instructs the SkyVUE PRO to turn the laser off until either a power cycle or the sensor is instructed to turn the laser back on.
LASERON	No parameters	Instructs the SkyVUE PRO to try and turn the laser on
LOADOS	Module	Loads new operating system into modules as follows: Module =1, DSP. Note: Operating systems earlier than 4 will need the boot loader updating. Refer to Loading a new operating system (OS) (p. 59) for more information. Module =2 Module =3, PSU Module =4, DSP, TOP, and PSU as one file. Only supported from operating system.

Table 5-1: Summary of the terminal mode commands available

Command	Parameter/ parameter block	Description
MCFG	Message_Interval Message_ID_A Message_ID_B Message_ID_C Message_ID_D Message_ID_E	Set or read message configuration Message_Interval is the message interval in seconds. Range is 2 to 600 s (default 10); 0 gives polled messages. Note: This command may affect measurement parameters within the BS command. See Measurement and message intervals (p. 47). Message_ID is the message type to output between 0 and 999 (default 001). If Message_ID = 0, no message type is output. Up to five messages can be set (refer to MCFG command message types (p. 46)).
MLH (if available)	Temporal_Filter Range_Filter Std_Width Q1_Threshold Q2_Threshold Q3_Threshold	Sets or reads parameters used in identifying mixing layer heights Temporal_Filter = temporal filter half width used to filter data used by mixing layer height algorithm in minutes. Range is 1 to 40 minutes (default 30 minutes) Range_Filter = range filter half width used to smooth data used by mixing layer height algorithm in meters or feet. Range is 15 m to 600 m or 49 ft to 1969 ft (default 150 m or 492 ft). Std_Width = range half width used to calculate standard deviation of the slope in meters or feet. Range is 10 m to 400 m or 33 ft to 1312 ft (default 150 m or 492 ft). Q1_Threshold = SNR threshold for quality level 1 mixing layer height output. Range is 1.0 to 30.0 (default 1.8) Q2_Threshold = SNR threshold for quality level 2 mixing layer height output. Range is 1.0 to 30.0 (default 5.0).

Table 5-1: Summary of the terminal mode commands available

Command	Parameter/ parameter block	Description
		Q3_Threshold = SNR threshold for quality level 3 mixing layer height output. Range is 1.0 to 30.0 (default 10.0).
OPEN	ID Password	Opens the SkyVUE PRO terminal mode ID = Sensor ID as per the terminal ID command. AnySkyVUE PRO with firmware OS2 or newer will respond to global ID = 99, regardless of its own ID number. Password = The sensors user password as per the terminal PASSWORD command. The default is no password.
PASSWORD	Password	Sets or clears a password from 1 to 10 characters in length. Valid characters, 0-9, a - z or A – Z, and letters are case sensitive. Typing the PASSWORD command without any parameters clears the password. The default is no password.
POLL	Sensor_ID Message_ID	Requests Message_ID from Sensor_ID . Refer to Message polling (p. 58) for more information on this command Note: If Message_ID is omitted, the SkyVUE PRO outputs the message configured by MCFG .
POWEROFF	No parameters	Prepares the PSU to power down the SkyVUE PRO even if the battery is connected. As soon as the mains supply is disconnected, the SkyVUE PRO will power off and NOT run on battery back-up. The SkyVUE PRO can be re-activated with battery back-up enabled by reconnecting the mains supply. You will be asked to confirm.
REBOOT	No parameters	Forces a system reboot. This will restore previously saved user settings. Any unsaved changes will be lost. (Settings are saved in the terminal mode when the

Table 5-1: Summary of the terminal mode commands available

Command	Parameter/ parameter block	Description
		CLOSE command is typed, which exits the terminal mode).
SCCAL	No parameters but user interaction required	Stratocumulus backscatter calibration. This requires a human observer to confirm a stable Stratocumulus cloud layer between 250 m to 2500 m without holes, precipitation or reduced visibility and has been stable for at least 10 minutes prior to running this command. See Stratocumulus backscatter calibration (p. 62) for more information.
SERIAL	Mode Baud Bits_Parity Delay	Set or read the serial port. Mode = 0, RS-232, full duplex (default) Mode = 1, RS-232, half duplex Mode = 2, RS-485, full duplex Mode = 3, RS-485, half duplex Mode = 4, reserved Mode = 5, RS-422, full duplex Baud = 0, 300 baud Baud = 1, 600 baud Baud = 2, 1200 baud Baud = 3, 2400 baud Baud = 4, 4800 baud Baud = 5, 9600 baud Baud = 6, 19200 baud Baud = 7, 38400 baud Baud = 8, 57600 baud Baud = 9, 76800 baud Baud = 10, 115200 baud (default) Bits_Parity = 0, 8 bits, no parity, 1 stop bit

Table 5-1: Summary of the terminal mode commands available

Command	Parameter/ parameter block	Description
		(default) Bits_Parity = 1, 7 bits, even parity, 1 stop bit Bits_Parity = 2, 7 bits, odd parity, 1 stop bit Delay = delay time, in milliseconds, before transmitting (RS-485 half-duplex mode only). Range: 0 to 100 ms (default 100 ms).
SERVICE	No parameters but user intervention required	Performs a service procedure
SETUSER	String	Load all user settings as a string of text. (not changed) = parameter will not be updated and the previously set value will persist. String = user (not changed) vo1Ver = user volume version (not changed) OS_VER = DSP OS version (not changed) PsuOsVer = PSU OS version (not changed) TopOsVer = TOP OS version (not changed) Id = SkyVUE PRO ID (not changed) Pw = SkyVUE PRO password (not changed) terminalCrc = terminal crc mode terminalTimeout = terminal timeout unitsTiltMode = units and tilt mode hoodHBMode = hood heater / fan heater mode hoodHBTestInt = hood heater / blower test interval in hours battBoost_mV = boost voltage used for battery charging mV battCharge_mA = battery charge current mA

Table 5-1: Summary of the terminal mode commands available

Command	Parameter/ parameter block	Description
		<p>psuPresent = PSU present switch</p> <p>hoodHBNormSpeed = Fan voltage for normal speed, mV</p> <p>hoodHBHighSpeed = Fan voltage for high speed, mV</p> <p>hoodHBLowSpeed = Fan voltage for low speed, mV</p> <p>intHMode = internal heater mode</p> <p>message[0] = fields for message 0</p> <p>message[1] = fields for message 1</p> <p>message[2] = fields for message 2</p> <p>message[3] = fields for message 3</p> <p>message[4] = fields for message 4</p> <p>messagePeriod = output message period in seconds</p> <p>heightOffset = height offset meters</p> <p>bsAvTime = backscatter average time in seconds</p> <p>laserMode = laser operation mode</p> <p>laserPower = laser power</p> <p>laserHeater = laser heater mode</p> <p>attenuatedSCALE = attenuated backscatter scaling factor</p> <p>logInterval = debug logging interval</p> <p>measurementPeriod = measurement interval in seconds</p> <p>serMode = serial port mode</p> <p>baudSel = serial port baud rate mode</p> <p>dataParityStop = serial port parity mode</p>

Table 5-1: Summary of the terminal mode commands available

Command	Parameter/ parameter block	Description
		<p>rx2txTimeout = serial port RX to TX turnaround time</p> <p>snrMarginBoundary = onset of back-scatter detection threshold</p> <p>snrMarginDetector = cloud detection threshold</p> <p>alphaGuessEnd = cloud alpha guess at boundary</p> <p>alphaMin = cloud detection alpha minimum</p> <p>Vc1d_D = cloud detection</p> <p>delta_Vc1d_D = cloud detection</p> <p>vis_Av_T = cloud detection</p> <p>alphaGuess = visibility initial alpha guess</p> <p>ratioLevel = visibility ratio</p> <p>alphaMin = visibility alpha minimum</p> <p>cap = visibility cap in meters</p> <p>tiltLimit = tilt limit in degrees used by alarms</p> <p>noiseGate = attenuated backscatter noise gate mode</p> <p>vvLimit_percent = sky condition report vertical visibility %</p> <p>alphaGuessStart = cloud detection alpha guess at lowest height bin</p> <p>dt</p> <p>dr</p> <p>q1threshold = mixing layer height quality threshold 1</p> <p>q2threshold = mixing layer height quality threshold 2</p> <p>q3threshold = mixing layer height quality</p>

Table 5-1: Summary of the terminal mode commands available

Command	Parameter/ parameter block	Description
		<p>threshold 3</p> <p>stdWidth = mixing layer height standard deviation width in meters</p> <p>c1oudMode = cloud detector mode parameter (03072019a)</p> <p>CRC = 4-digit character. CRC calculated from the u up to but not including the CRC using the standard CRC-16.</p> <p>Note: String is added as text and should be cut and pasted from a stored file.</p>
STATUS	No parameters	<p>Outputs SkyVUE PRO, serial number, ID, DSP OS version, Time and Date, DSP version, TOP OS version, PSU OS version, watch dog counts, serial parameters, blower heater mode, internal heater mode, message parameters, tilt angle, units, temperature/humidity, temperatures, supply voltages, height offset, visibility cap, laser run days, window parameters, backscatter parameters, MLH parameters, features, alarms, warnings, and status.</p> <p>Note: Refer to Status command (p. 49) for more information on this command</p>
TERMINAL	Terminal Timeout	<p>Sets the user terminal time out.</p> <p>Timeout is the delay in minutes from 1 to 15 where the terminal will automatically close if no characters are sent to the SkyVUE PRO. The default is 10 minutes.</p>
TIME	Date_Time	<p>Date is in the format yyyy/mm/dd</p> <p>Time is in the format hh:mm:ss</p> <p>yyy=year, mm=month, dd=day</p> <p>hh=hours, mm=minutes, ss=seconds</p>

Table 5-1: Summary of the terminal mode commands available

Command	Parameter/ parameter block	Description
		For example: time 2013/05/25 10:00:00, sets the date and time to May 25, 2013 at 10:00:00) Note: The set time could drift by up to ± 14 seconds a day.
UNITS	Units	Sets measurement units and tilt correction Units = 0, meters corrected by tilt Units = 1, meters not corrected by tilt Units = 2, feet corrected by tilt (default) Units = 3, feet not corrected by tilt
UNLOCK	Key	Key = a 12 digit key purchased from Campbell Scientific. The key unlocks features such as Mixing Layer Height assessment. The key is specific to the individual SkyVUE PRO and only has to be entered once.
VIS	Cap	Cap is the vertical visibility maximum range 100 to 10000 in meters or 328 to 32808 in feet (default 2000 m or 6561 ft).

NOTE:

If AUTO is set, then the heater / blower will heat to 80 °C if (sky condition > 1 okta coverage) or (cloud height < 3 km (9842 ft) AND sky condition > 1 okta coverage) OR window Tx < 80% OR precipitation detected. When the event has passed, the blower/heater will remain active at 80 °C for a further 15 minutes before going into a fan-off state and the heater temperature drops to an average of approximately 40 °C, ready to be activated again.

5.1.4 Application command message types

The **Application_n** parameter for the APPLICATION command defines settings to optimize the ceilometer for a range of applications, Aviation, Research and Meteorology. The default application setting for the SkyVUE PRO is Meteorology, but this can be changed, or returned to, using the **Application_n** command.

Users can adjust any element of these settings once an application has been applied through the following individual commands: **ALARMS**, **BS**, **CLOUDMODE**, **MCFG** and **UNITS**.

Settings	Application modes for SkyVUE PRO using OS13 and newer				Defaults using OS12 and older
	Aviation	Research	Air quality	Meteorology (default)	General application
ALARMS (tilt degs)	30	45	45	45	45
APPLICATION: Application n (sets user application settings)	Application 10	Application 20	Application 30	Application 40	N/A
BS: Attenuated scale (%)	100	100	100	100	100
BS: Backscatter averaging time (s)	2	7	7	7	7
BS: Noise Gate	2 (ON)	-1000 (OFF)	2 (ON)	-1000 (OFF)	-1000 (OFF)
BS: Measurement Period (s)	10	10	10	10	10
BS: Rolling Averages (sets the number of readings for averaging. Alternative description: Backscatter temporal filter rolling samples)	3	6	6	3	3
BS: Message Interval (s)	30	30	30	30	30
BS: BS_Temporal_Filter_Mode (Sets Averaging or Median Mode.)	1 (Median)	0 (Average)	0 (Average)	0 (Average)	N/A (Average)
CLOUDMODE: CloudMode_A (Reports highest cloud only during precipitation)	ON	OFF	OFF	ON	N/A

Table 5-2: Summary of applications and applied settings for SkyVUE PRO

Settings	Application modes for SkyVUE PRO using OS13 and newer				Defaults using OS12 and older
	Aviation	Research	Air quality	Meteorology (default)	General application
MCFG: Message ID	4 (CB,SC,BS)	6 (CB,SC,MLH,BS)	6 (CB,SC,MLH,BS)	4 (CB,SC,BS)	4 CB,SC,BS)
UNITS	2 (Feet, tilt corrected)	0 (Meters, tilt corrected)	0 (Meters, tilt corrected)	0 (Meters, tilt corrected)	0 (Meters, tilt corrected)

5.1.5 MCFG command message types

The **Message_ID_x** parameter for the MCFG commands defines the output types. Refer to [Messages](#) (p. 68) for further information on message output types.

Table 5-3: Summary of message ID and descriptions

Message_ID_x type	Description
000	No message
001	Campbell Scientific Message 1, no sky condition, no profile data
002	Campbell Scientific Message 2, no sky condition, profile data, 2048 range bins, 5 m resolution
003	Campbell Scientific Message 3, sky condition, no profile data
004 (default)	Campbell Scientific Message 4, sky condition and profile data, 2048 range bins, 5 m resolution
005 ¹	Campbell Scientific Message 5, sky condition, no profile data, mixing layer height
006 ¹	Campbell Scientific Message 6, sky condition, profile data, 2048 range bins, 5 m resolution, mixing layer height
101	CL31 Message 1, 770 range bins, 10 m resolution
102	CL31 Message 1, 385 range bins, 20 m resolution

Table 5-3: Summary of message ID and descriptions

Message_ID_x type	Description
103	CL31 Message 1, 1500 range bins, 5 m resolution
104	CL31 Message 1, 770 range bins, 5 m resolution
105	CL31 Message 1, No profile data
106	CL31 Message 1, Full SkyVUE PRO output, 2048 range bins, 5 m resolution
107	CL31 Message 2, 770 range bins, 10 m resolution
108	CL31 Message 2, 385 range bins, 20 m resolution
109	CL31 Message 2, 1500 range bins, 5 m resolution
110	CL31 Message 2, 770 range bins, 5 m resolution
111	CL31 Message 2, No profile data
112	CL31 Message 2, Full SkyVUE PRO output, 2048 range bins, 5 m resolution
113	CT25K Message 1
114	CT25K Message 6

¹Only available if MLH option is active.

5.1.6 Measurement and message intervals

The message interval is the time, in seconds, between the automatic message transmissions. It can be set between 2 to 600 s (0 gives polled messages). The default is 10, meaning a message will be sent automatically every 10 seconds. The message interval must be a multiple of the measurement period.

The backscatter average time, **BS_Av_Time**, is the period over which the laser is firing and taking measurements.

The measurement period is the time interval between the start of backscatter average time (**BS_Av_Time**), during which the laser fires, and the start of the next measurement period. The measurement period must be long enough to include the backscatter average time and some processing time. The minimum measurement period is 2 seconds, which assumes the backscatter average time is 1 second. The measurement period can be set between 2 to 600 s (default is 10 s). If it is set to 0, then measurements must be polled.

The rolling average (1 to 29, default 1) is the number of periods used to calculate each scatter value that is either used in a profile message or in a calculation of cloud height.

The message interval chosen may affect measurement parameters allowed within the BS command, which can be used to set non-standard measurement parameters) as follows:

If message interval = measurement period = 2 (the lowest values allowed), then the backscatter average time (BS_Av_Time) must equal 1 and the rolling average must equal 1.

If the message interval is between 3 and 9 s, then the measurement period must be the same as the message interval.

 In the following examples, yellow means laser firing.

To comply with the requirements for Sky Condition the total measurement period for rolling averages should not exceed 30 seconds.















In this case, the SkyVUE PRO sends a message every 2 seconds based on one measurement averaged over 1 second. Therefore, each message is based on a single 1 second period of backscatter average data.

Laser firing (yellow)																			
(BS_AV_Time) = 1 s	1 s																		
Measurement Period = 2 s	2 s																		
Message Interval = 2 s	2 s																		















In this case, with the rolling average set to 1, the SkyVUE PRO sends a message every 30 seconds. It takes three, 2 second, measurements at 10 second intervals. Only the last measurement is used in the output message but all three are used for calculating sky condition. Therefore, each message is based on a single 2 second period of backscatter average data.

Laser firing (yellow)																			
(BS_AV_Time) = 2 s	2 s																		
Measurement Period = 10 s	10 s									10 s									
Message Interval = 30 s	30 s																		











In this case, with the rolling average set to 3, the SkyVUE PRO sends a message every 30 seconds that contains the average of the latest three measurements. Therefore, each message is based on three, 10 second measurement periods, with each containing 2 seconds of backscatter average data.

Laser firing (yellow)														
(BS_AV_Time) = 2 s	2 s													
Measurement Period = 10 s	10 s			10 s			10 s							
Message Interval = 30 s	30 s													

In this case, with the rolling average set to 3 (default), the SkyVUE PRO sends a message every 10 seconds that contains the average of the latest three measurements. Therefore, each message is based on three, 10 second measurement periods, with each containing 2 seconds of backscatter average data.

Laser firing (yellow)														
(BS_AV_Time) = 2 s	2 s													
Measurement Period = 10 s	10 s			10 s			10 s							
Message Interval = 10 s	10 s			10 s			10 s							

In this case, the SkyVUE PRO sends a message every 14 seconds based on one measurement taking 4 seconds over a 14 second interval. Therefore, each message is based on a single 4 second period of average data.

Laser firing (yellow)												
(BS_AV_Time) = 4 s												
Measurement Period = 14 s	14 s			14 s			14 s			14 s		
Message Interval = 14 s	14 s			14 s			14 s			14 s		

This message cannot be set up using the MCFG command alone.

The BS command has to be used as follows:

BS_Av_Time (averaging period) has to be set to 4, not the default value.

5.1.7 Status command

The STATUS command returns the following information:

Line	Example line output
1	Identification CS135 SN1000 ID 0
Description of the line sections	
Section	Description
CS135	Product name
SN1000	Sensor serial number
ID 0	Sensor identification number

Line	Example line output
2	Date Time 2012/01/10 11:39:46
Description of the line sections	
Section	Description
2012/01/10	Date in the format yyyy/mm/dd
11:39:46	Time in the format hh:mm:ss

Line	Example line output
3	DSP_OS A
Description of the line sections	
Section	Description
A	DSP OS revision number

Line	Example line output
4	TOP_OS 1
Description of the line sections	
Section	Description
A	TOP board OS revision number

Line	Example line output
5	PSU_OS 1
Description of the line sections	
Section	Description
A	PSU board OS revision number

Line	Example line output
6	Watchdog A
Description of the line sections	
Section	Description
A	Watchdog counter for unscheduled system resets

Line	Example line output
7	Serial A B C D
Description of the line sections	
Section	Description
A	Serial mode (Note: Refer to the SERIAL command)
B	Serial baud rate (Note: Refer to the SERIAL command)
C	Parity and stop bits (Note: Refer to the SERIAL command)
D	Receive to transmit delay time in RS-485 mode (Note: Refer to the SERIAL command)

Line	Example line output
8	Heaters A B C D
Description of the line sections	
Section	Description
A	Hood blower mode
B	Internal heater mode
C	Laser heater mode
D	Heater/blower test interval in hours

Line	Example line output
9	MCFG X A B C D E
Description of the line sections	
Section	Description
X	Message interval (Note: Refer to the MCFG command)
A	Message ID A (Note: Refer to the MCFG command)
B	Message ID B (Note: Refer to the MCFG command)
C	Message ID C (Note: Refer to the MCFG command)
D	Message ID D (Note: Refer to the MCFG command)
E	Message ID E (Note: Refer to the MCFG command)

Line	Example line output
10	Angle A B C
Description of the line sections	
Section	Description
A	X axis tilt
B	Y axis tilt
C	Beam angle from vertical

Line	Example line output
11	Units A
Description of the line sections	
Section	Description
A	Measurement units and tilt correction. (Note: Refer to the UNITS command)

Line	Example line output
12	TRH A B C
Description of the line sections	
Section	Description
A	Sensor internal temperature reading in degrees Celsius
B	Sensor internal humidity reading as a percentage
C	Sensors internal dew point value in degrees Celsius

Line	Example line output
13	T A B C D E F
Description of the line sections	
Section	Description
A	External fan blower assembly temperature in degrees Celsius
B	PSU internal temperature in degrees Celsius
C	TOP board laser monitor temperature in degrees Celsius
D	TOP board calibration LED temperature in degrees Celsius
E	Laser module temperature in degrees Celsius
F	Photo diode module temperature in degrees Celsius

Line	Example line output
14	SupplyVoltage A B
Description of the line sections	
Section	Description
A	DSP board supply voltage
B	PS135E internal supply voltage
C	Cyclic power cycle counter. Resets after 31 cycles

Line	Example line output
15	HOffset A
Description of the line sections	
Section	Description
A	Height offset reported in feet or meters dependent upon the UNITS command

Line	Example line output
16	Visibility Cap A
Description of the line sections	
Section	Description
A	Vertical visibility maximum range

Line	Example line output
17	LaserRunDays A
Description of the line sections	
Section	Description
A	Number of days that the laser module has been active for

Line	Example line output
18	WindowTX A
Description of the line sections	
Section	Description
A	Window transmittance %

Line	Example line output
19	BS A B C D E F (Note: refer to the BS command)
Description of the line sections	
Section	Description
A	Attenuated scale
B	Averaging time
C	Noise Gate
D	Measurement period
E	Rolling average
F	Message interval

Line	Example line output
20	MLH A B C D E F (Note: refer to the MLH command)
Description of the line sections	
Section	Description
A	Temporal filter
B	Range filter
C	STD width
D	Q1 threshold
E	Q2 threshold
F	Q3 threshold

Line	Example line output
21	Features A
Description of the line sections	
Section	Description
A	List of features enabled

Line	Example line output
22	Flags 0000 0000 0000
Description of the most significant alarm word (left side, bits going left to right). Each alarm word is a hexadecimal sum of all the error bits.	
Bit	Description
8000 XXXX XXXX	Units. feet = 0, meters = 8
4000 XXXX XXXX	Reserved for future use
2000 XXXX XXXX	Reserved for future use
1000 XXXX XXXX	Reserved for future use
0800 XXXX XXXX	DSP clock out of specification
0400 XXXX XXXX	Laser shut down due to operating temperature out of range
0200 XXXX XXXX	The lead acid battery voltage is reading low
0100 XXXX XXXX	Mains supply has failed (requires a PSU to be present)
0080 XXXX XXXX	The external heater blower assembly temperature is out of bounds
0040 XXXX XXXX	External heater blower failure
0020 XXXX XXXX	The PSUs internal temperature is high
0010 XXXX XXXX	PSU OS has failed its signature check
0008 XXXX XXXX	No communications between DSP and PSU
0004 XXXX XXXX	Photo diode and Laser windows are dirty. This can only be set if the laser is on
0002 XXXX XXXX	Tilt beyond limit set by user, default 45 degrees
0001 XXXX XXXX	No communications between DSP and inclinometer board

Description of the middle alarm word (middle word, bits going left to right)	
Bit	Description
XXXX 8000 XXXX	The sensors internal humidity is high
XXXX 4000 XXXX	Communications to the DSP boards temperature and humidity chip have failed
XXXX 2000 XXXX	DSP input supply voltage is low
XXXX 1000 XXXX	Self-test active
XXXX 0800 XXXX	Watch dog counter updated
XXXX 0400 XXXX	User setting stored in flash failed their signature checks
XXXX 0200 XXXX	DSP factory calibration stored in flash has failed its signature check
XXXX 0100 XXXX	DSP board OS signature test failed
XXXX 0080 XXXX	DSP board RAM test failed
XXXX 0040 XXXX	DSP boards on board PSUs are out of bounds
XXXX 0020 XXXX	TOP board non-volatile storage is corrupt
XXXX 0010 XXXX	TOP board OS signature test has failed
XXXX 0008 XXXX	TOP boards ADC and DAC are not within specifications
XXXX 0004 XXXX	TOP boards on board PSUs are out of bounds
XXXX 0002 XXXX	Communications have failed between TOP board and the DSP
XXXX 0001 XXXX	Photo diode background radiance is out of range

Description of the least significant alarm word (right side, bits going left to right)	
Bit	Description
XXXX XXXX 8000	Photo diode temperature is out of range
XXXX XXXX 4000	Photo diode is saturated
XXXX XXXX 2000	Photo diode calibrator temperature is out of range
XXXX XXXX 1000	Photo diode calibrator has failed
XXXX XXXX 0800	The sensor could not reach the desired gain levels
XXXX XXXX 0400	Laser run time has been exceeded
XXXX XXXX 0200	Laser temperature out of range
XXXX XXXX 0100	Laser thermistor failure
XXXX XXXX 0080	Laser is obscured. This can only be set if the laser is on
XXXX XXXX 0040	Laser did not achieve significant output power
XXXX XXXX 0020	Laser max power exceeded
XXXX XXXX 0010	Laser max drive current exceeded
XXXX XXXX 0008	Laser power monitor temperature out of range
XXXX XXXX 0004	Laser power monitor test fail
XXXX XXXX 0002	Laser shutdown by top board
XXXX XXXX 0001	Laser is off

5.1.8 Message polling

The `POLL Sensor_ID Message_ID` command requests the `Message_ID` from the `Sensor_ID`. Where `Message_ID` is a SkyVUE PRO message type as defined in [MCFG command message types](#) (p. 46).

The following example uses the SkyVUE PRO `POLL` command to request preconfigured message outputs.

First configure the SkyVUE PRO to use polling mode from the terminal interface via the `MCFG` command as follows:

```
CS135> MCFG 0
010000
```

This configures the SkyVUE PRO into polling mode leaving your message output configurations unchanged. Exit the terminal by typing the **CLOSE** command. This will save the changes you just made.

```
CS135> CLOSE
```

```
COMMAND CLOSED
```

Automatic message outputs should continue. Type the **POLL** command as shown below to verify that the system is working as expected.

NOTE:

Once exited, the terminal characters will not be automatically echoed back to you.

```
POLL 0
```

This should return all messages you have set via the **MCFG** command. In this example, only default message output was set. Therefore, the **POLL** command returns text similar to the following.

NOTE:

If you have no message configured, the **MCFG** command returns **0 0 0 0 0**, then nothing will be returned from the command you just typed.

```
CS0100001
```

```
10 100 12345 ///// ///// ///// 000000000000
```

```
abcd
```

The following example shows how to use the **POLL** command to request a specific message output type.

To poll the SkyVUE PRO for a particular message type, enter the following.

```
POLL 0 113
```

This command requests CT25K Message 1 and should look similar to the following.

```
CT00010
```

```
10 12345 ///// ///// 00000f80
```

5.1.9 Loading a new operating system (OS)

A new OS can be entered with the **LOADOS** module command. The three different modules have their own OS. The parameter module loads a new operating system into different modules as follows:

Module =1, DSP (file type *.ldr)

Module =2, TOP (file type *. hex)

Module =3, PSU (file type*. hex)

Module =4, DSP, TOP, and PSU as one file type *.ldr. This is the usual method.

NOTE:

The new OS must be sent using xmodem protocol using Tera Term. See [Terminal mode commands general](#) (p. 28).

To load a new operating system:

Enter terminal mode by typing **Open 0** (for a sensor with the default ID 0)

This will return the prompt: **CS135>**

Type the command: **LOADOS 4**

Or, type the command: **LOADOS**

The SkyVUE PRO will respond:

Load OS into DSP

DO NOT REMOVE POWER DURING OS UPDATE!!!

Waiting for xmodem

At this point, use your terminal emulator to send the appropriate file. Loading the OS could take a few minutes.

When the process is complete the SkyVUE PRO will return the message:

Wait 40 sec for OS to restart

Afterwards, the SkyVUE PRO will resume operation according to the previously set operating parameters. It will no longer be in terminal mode.

To load a new operating system into a SkyVUE PRO with an OS between 4 and 7:

Enter terminal mode by typing: **Open 0** (for a sensor with the default ID of 0)

This will return the prompt **CS135>**

Type the command **LOADOS 1**

The SkyVUE PRO will respond:

Load OS into DSP

DO NOT REMOVE POWER DURING OS UPDATE!!!

Waiting for xmodem

At this point, use your terminal emulator to send the *.ldr file using xmodem protocol. Loading the OS could take a few minutes. When the process is complete the SkyVUE PRO will return the message: Wait 40 sec for OS to restart. Afterwards, the SkyVUE PRO will resume operation according to the previously set operating parameters. It will no longer be in terminal mode.

CAUTION:

Do not reboot the SkyVUE PRO at this point.

Again enter terminal mode by typing **Open 0** (for a sensor with the default ID 0)

This will return the prompt: **CS135>**

Type the command: **LOADOS 4**

The SkyVUETMPRO will respond:

Load OS into DSP

DO NOT REMOVE POWER DURING OS UPDATE!!!

Waiting for xmodem

At this point, use your terminal emulator to send the *.ldr file using xmodem protocol.

Loading the OS could take a few minutes.

When the process is complete the SkyVUE PRO will return the message: Wait 40 sec for OS to restart. Afterwards, the SkyVUE PRO will resume operation according to the previously set operating parameters. It will no longer be in terminal mode.

To load a new operating system into a SkyVUE PRO with an OS between 1 and 3

Operating systems earlier than 4 will need the boot loader updating, use the **LOADOS 1** command, not **LOADOS 4**, before a new DSP OS can be uploaded. You will get the following verify error code the first time the OS is loaded:

Error writing word 32768

Verify OS

Error verifying word 327680 37020 4236

Reboot then load the OS using the terminal command **LOADOS 4** to correctly load the OS without errors.

The process is as follows:

Enter terminal mode by typing **Open 0** (for a sensor with the default ID 0)

This will return the prompt: **CS135>**

Type the command: **LOADOS 1**

The SkyVUETMPRO will respond:

Load OS into DSP

DO NOT REMOVE POWER DURING OS UPDATE!!!

Waiting for xmodem

At this point, use your terminal emulator to send the *.ldr file using xmodem protocol.

Loading the OS could take a few minutes.

When the process is complete the SkyVUE PRO will return the message:

Error writing word 32768

Verify OS

Error verifying word 327680 37020 4236

Use the REBOOT command. Wait 40 sec for OS to restart after which it will resume operation according to the previously set operating parameters. It will no longer be in terminal mode.

Enter terminal mode by typing **Open 0** (for a sensor with the default ID 0).

This will return the prompt: **CS135>**

Type **LOADOS 4**

The SkyVUE PRO will respond:

Load OS into DSP

DO NOT REMOVE POWER DURING OS UPDATE!!!

Waiting for xmodem

At this point, use your terminal emulator to send the *.ldr file again using xmodem protocol.

Loading the OS could take a few minutes.

When the process is complete the SkyVUETMPRO will return the message: Wait 40 sec for OS to restart.

The SkyVUE PRO will resume operation according to the previously set operating parameters. It will no longer be in terminal mode.

It is good practice to reboot the sensor after loading a new OS.

5.1.10 Stratocumulus backscatter calibration

The **SCCAL** command allows a simple stratocumulus backscatter calibration of the scatter coefficient measurements. This requires a human observer to confirm a stable Stratocumulus cloud layer between 250 m (820 ft) to 2500 m (8202 ft) without holes, precipitation or reduced visibility, and has been stable for at least 10 minutes prior to running this command.

Set the **Measurement_Period** to 10 (see [Table 5-1](#) (p. 30)).

A detailed description of this technique is given in: Ewan J. O'Connor, Anthony J. Illingworth, and Robin J. Hogan, 2004: A Technique for Autocalibration of Cloud Lidar. *Journal of Atmospheric and Ocean Technology*, **21**, pp 777 – 786.

Enter terminal mode by typing **Open 0** (for a sensor with an ID of 0)

This will return the prompt: **CS135>**

Type **SCCAL**

The SkyVUE PRO will respond:

Stratocumulus calibration.

Enter height above sea level (m)? Press enter to continue:

Enter the sensor height above sea level, for example 70 m then type return.

The SkyVUE PRO will respond: **70 m entered, is this correct? "Y", "N" or "Q"**

Type **Y** to confirm. If you have entered an incorrect number, type **N** and you will be able to replace it. Type **Q** to quit the calibration and return to the terminal command prompt.

The SkyVUE PRO will respond:

For correct calibration a trained human observer must confirm that the layer is between 250 m (820 ft) to 2500 m (8200 ft) and has been stable for at least 10 minutes without drizzle. Has the Stratocumulus been stable for at least 10 minutes? "Y" or "N"

To confirm, type **Y** and the SkyVUE PRO will respond:

Old Stratocumulus calibration = 0.0282

New Stratocumulus calibration parameters = 0.0258 70 1328

Do you want to apply this calibration? "Y" or "N"

In this example, 70 is the height of the sensor above sea level previously entered and 1210 is the cloud base in meters above the sensor.

As a rough guide, if the calibration factor has changed by less than 20%, there is no need to change. If it has changed by a factor of 2, it is wise to run the service routine on the sensor (see [Service command](#) (p. 65)).

Type **Y** to confirm and the SkyVUE PRO will respond:

Calibration saved.

The following error messages may appear during the process.

- Error ... Time out
- Error ... Cloud not detected or height not within limits (250 m to 2500 m / 820 ft to 8200 ft)
- Try again when layer is stable
- Error ... Not enough data available try again in 10 minutes.

5.1.11 CRC-16 codes on terminal commands

If CRC-16 on mode is set using the **Terminal** command, all terminal commands need a CRC-16. A semi-colon is used to indicate start of the CRC-16 in 4-byte character, for example **open 0;233A**. The CRC-16 is calculated either from the start of a new line or after a [STX] up to but not including the semi-colon. ETX can follow the CRC-16 if required.

To find the valid CRC-16 for a command, type the command and then type: ;?????. For example, typing **open 0;????** gives the response [CRLF]CRC>233A<CRC[CRLF] so **233A** is the CRC-16.

The CRC-16 is not case sensitive.

NOTE:

Make sure the terminal software sends [CR] and not [CRLF] for the command-line termination.

The table below gives some commonly used CRC-16 codes.

Terminal command	CRC-16
open 0	233A
close	D94E
status	7CE5
password	EB85
terminal 0 (this command will remove CRC-16 checking)	B576
defaults	7D8E
serial	7FCE

5.1.12 Service command

The service command triggers the SkyVUE PRO to go through a series of tests including tests that require the white test surface (ceilometer calibration plate supplied) to be placed on the SkyVUE PRO windows.

The service command results in the following procedures:

- System noise level including noise spike test
- Detector maximum gain test
- Simulates a clear night sky for calibration offset
- Window contamination functionality test
- Laser function and monitoring alarm check
- Thermistor fault alarm check
- Calibrator LED alarm check
- PSU supply alarm check
- Temperature RH% sensor alarm check
- Inclinator alarm check
- Heater/blower alarm check
- Internal clocks alarm check
- Top board and PSU communications alarm check.

If any test or check has failed, then full instrument status and debug information is output with a fault summary at the end.

The response is similar to the following:

Initially the SkyVUE PRO outputs a STATUS message, then goes through various self-test routines before requesting a white test surface to be placed over each of the windows in turn. This process is as follows:

self test, please wait

wait for new measurement.....

Place white test surface onto detector window (left side fan at the top)

Press Enter to continue

Cover the detector window and press **Enter** . The computer will respond:

wait for new measurement.....

Place white test surface onto laser window (right side fan at the top)

Press Enter to continue

Cover the laser window and press **Enter** . The computer will respond:

wait for new measurement.....

Remove white test surface from laser window. Press Enter to continue.

When this is complete, the SkyVUE PRO will output a string of diagnostic data similar. This is useful for a Campbell Scientific engineer investigating problems with the SkyVUE PRO.

Finally, the SkyVUE PRO will list any faults found as shown below:

```
***** CS135 FAULT list *****
```

```
FAULT - external heater/blower thermistor
```

```
FAULT - detector dirty windows with white test surface
```

```
FAULT - max APD gain not achieved
```

Otherwise it will report the following message:

```
***** CS135 has PASSED all tests *****
```

5.1.13 Locked features

Optional features such as Mixing Layer Height assessment are protected by a key. They are enabled by typing UNLOCK followed by entering the key. This is specific to the individual SkyVUE PRO and only has to be entered once.

5.2 Restoring factory defaults

Restore factory defaults by using the DEFAULTS command in the terminal mode.

Hard Reset

Alternatively, use the RESET push switch on the DSP to restore factory defaults ([FIGURE 5-1](#) (p. 67)).

Remove the cover and enclosure lid. See [Removing the cover](#) (p. 104) and [Removing the enclosure lid](#) (p. 105).

WARNING:

Opening the access lid MUST be carried out by a competent person, who has sufficient training, experience and knowledge both in electrical safety and the detail and operation of the sensor.

WARNING:

Opening the access lid may expose hot surfaces.

Use a narrow tool such as a screw driver to reach the reset switch.

If the reset switch is pushed for four seconds, the SkyVUE PRO will reboot in exactly the same way as the REBOOT terminal command. If it is held closed while the SkyVUE PRO is powered off and

on again, it will return to factory defaults. To power cycle the SkyVUE PRO, disconnect the battery and switch the main power off and on.



FIGURE 5-1. Restoring factory defaults

5.3 LED indicator

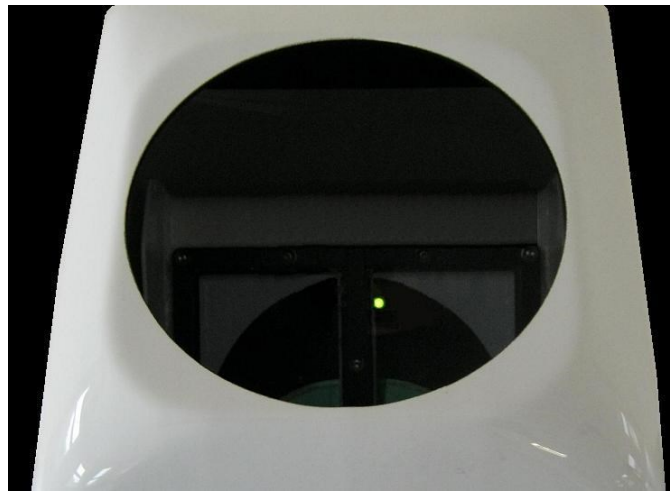

FIGURE 5-2. LED indicator

A green LED is visible through the window, see [FIGURE 5-2](#) (p. 67). It will give 0.5 second flashes as follows:

- 1 flash every 10 seconds = OK, no fault
- 2 flashes every 10 seconds = warning (possible degraded performance)
- 3 flashes every 10 seconds = alarm (measurements not possible)

6. Messages

6.1 Data messages general	68
6.2 Checksums used in SkyVUE PRO messages	68
6.3 CS messages	69
6.4 CL31 messages	89
6.5 CT25K messages	98

6.1 Data messages general

The SkyVUE PRO can provide a variety of data message types to allow efficient output of data. Not all messages provide the full information available, but these messages may be more efficient in terms of data storage and transmission.

CL31 and CT25K messages follow formats used by common existing CL31 and CT25K sensors allowing easier replacement or network expansion.

6.2 Checksums used in SkyVUE PRO messages

This is based on the CRC-16 with the output XOR'd with Hex 0xFFFF and outputs a two-byte CRC-16 character. The CRC-16 is calculated on all characters after the SOH character up to and including the ETX character.

The following example uses the C code to calculate the SkyVUE PRO checksum.

NOTE:

Shorts are 16 bits long and ints are 32 bits long.

```
// -----  
// Calculate CRC-16  
// buf is a pointer to the input string  
// len is the length of the input string  
// -----  
unsigned short crc16(char *buffer, int length)  
{  
    unsigned short crc;  
    unsigned short m;  
    int i, j;
```

```

crc = 0xFFFF;
for (i=0; i < length; ++i)
{
    crc ^= buffer[i] << 8;

    for (j=0; j<8; ++j){
        m = (crc & 0x8000) ? 0x1021 : 0;
        crc <<= 1;
        crc ^= m;
    }
}
crc ^= 0xFFFF;
return crc;
}

```

6.3 CS messages

6.3.1 MESSAGE 001 (no profile, no sky condition)

Example message line outputs

```

CS0001001
10 087 00139 // // // // 8000000000000
942f

```

LINE 1

SOH CS ID OS N STX CR LF

where

SOH = Start-of-Heading character

CS = Always "CS"

ID (1 character) = A single character, 0 to 9, a to z or A to Z, case sensitive. Default ID = 0

OS (3 characters) = Operating system, 001 to 999

N (3 characters) = Message number

STX = Start-of-Text Character

CR LF = Carriage Return + Line Feed

LINE 2

S WA_ tr_h1_h2_h3_h4_flags CR LF

where

S (1 character) = detection status:

0 = No significant backscatter

1 = One cloud base detected

2 = Two cloud bases detected

3 = Three cloud bases detected

4 = Four cloud bases detected

5 = Full obscuration determined but no cloud base detected

6 = Some obscuration detected but determined to be transparent

/ = Raw data input to algorithm missing or suspect

WA (1 character) = Warning or alarm status:

0 = No alarm or warning

W = Warning

A = Alarm

tr (3 characters) = Window transmission, %

h1 (5 characters) = 1st Height

If detection status is 1, 2, 3, or 4 h1 = Lowest cloud base reported

If detection status is 5 h1 = Vertical visibility as calculated

If detection status is 0 or 6 h1 = /////

h2 (5 characters) = 2nd Height

If detection status is 2, 3, or 4 h2 = Second cloud base reported

If detection status is 5 h2 = Highest signal received

If detection status is 0, 1, or 6 h2 = /////

h3 (5 characters) = 3rd Height

If detection status is 3 or 4 h3 = Third cloud base reported

If detection status is 0, 1, 2, 5, or 6 h3 = /////

h4 (5 characters) = 4th Height

If detection status is 4 h4 = Fourth cloud base reported

If detection status is 0, 1, 2, 3, or 5 h4 = /////

flags (12 characters in 3 groups of 4) = Alarm or warning information

Table 6-1: Most significant alarm word for CS messages	
Bit ¹	Description
8000 XXXX XXXX	Units. Feet = 0, meter = 1.
4000 XXXX XXXX	Reserved for future use

Table 6-1: Most significant alarm word for CS messages	
Bit ¹	Description
2000 XXXX XXXX	Reserved for future use
1000 XXXX XXXX	Reserved for future use
0800 XXXX XXXX	DSP clock out of specification
0400 XXXX XXXX	Laser shut down due to operating temperature out of range
0200 XXXX XXXX	The lead acid battery voltage is reading low
0100 XXXX XXXX	Mains supply has failed (requires a PSU to be present)
0080 XXXX XXXX	The external heater blower assembly temperature is out of bounds
0040 XXXX XXXX	External heater blower failure
0020 XXXX XXXX	The PSUs internal temperature is high
0010 XXXX XXXX	PSU OS has failed its signature check
0008 XXXX XXXX	No communications between DSP and PSU
0004 XXXX XXXX	Photo diode and Laser windows are dirty. This can only be set if the laser is on
0002 XXXX XXXX	Tilt beyond limit set by user, default 45 degrees
0001 XXXX XXXX	No communications between DSP and inclinometer board
¹ Alarm words are sum of error bits.	

Table 6-2: Middle alarm word for CS messages	
Bit ¹	Description
XXXX 8000 XXXX	The sensors internal humidity is high
XXXX 4000 XXXX	Communications to the DSP board temperature and humidity chip have failed
XXXX 2000 XXXX	DSP input supply voltage is low
XXXX 1000 XXXX	Self-test active
XXXX 0800 XXXX	Watch dog counter updated
XXXX 0400 XXXX	User setting stored in flash failed their signature checks

Table 6-2: Middle alarm word for CS messages

Bit ¹	Description
XXXX 0200 XXXX	DSP factory calibration stored in flash has failed its signature check
XXXX 0100 XXXX	DSP board OS signature test failed
XXXX 0080 XXXX	DSP board RAM test failed
XXXX 0040 XXXX	DSP boards on board PSUs are out of bounds
XXXX 0020 XXXX	TOP board non-volatile storage is corrupt
XXXX 0010 XXXX	TOP board OS signature test has failed
XXXX 0008 XXXX	TOP boards ADC and DAC are not within specifications
XXXX 0004 XXXX	TOP boards on board PSUs are out of bounds
XXXX 0002 XXXX	Communications have failed between TOP board and the DSP
XXXX 0001 XXXX	Photo diode background radiance is out of range
¹ Alarm words are sum of error bits.	

Table 6-3: Least significant alarm word for CS messages

Bit ¹	Description
XXXX XXXX 8000	Photo diode temperature is out of range
XXXX XXXX 4000	Photo diode is saturated
XXXX XXXX 2000	Photo diode calibrator temperature is out of range
XXXX XXXX 1000	Photo diode calibrator has failed
XXXX XXXX 0800	The sensor could not reach the desired gain levels
XXXX XXXX 0400	Laser run time or maximum laser drive current has been exceeded
XXXX XXXX 0200	Laser temperature out of range
XXXX XXXX 0100	Laser thermistor failure
XXXX XXXX 0080	Laser is obscured. This can only be set if the laser is on
XXXX XXXX 0040	Laser did not achieve significant output power
XXXX XXXX 0020	Laser max power exceeded
XXXX XXXX 0010	Laser max drive current exceeded

Table 6-3: Least significant alarm word for CS messages

Bit ¹	Description
XXXX XXXX 0008	Laser power monitor temperature out of range
XXXX XXXX 0004	Laser power monitor test fail
XXXX XXXX 0002	Laser shutdown by top board
XXXX XXXX 0001	Laser is off

¹ Alarm words are sum of error bits.

CR LF = Carriage Return and Line Feed

LINE 3

ETX CRC-16 EOT CR LF

where

ETX = End-of-Text character

CRC-16 (4 characters) = CRC-16 Checksum

EOT = End-of-Transmission character

CRLF = Carriage Return + Line Feed

6.3.2 MESSAGE 002 (Profile, no sky condition)

Example message line outputs

```
CS0001002
10 085 01123 ///// ///// ///// 800000000000
00100 05 2048 100 +40 02 0074 0070 30 000
0c5df047.....000000 (Line output cropped for clarity)
9f68
```

LINE 1

SOH CS ID OS N STX CR LF

where

SOH = Start-of-Heading character

CS = Always CS

ID (1 character) = A single character, 0 to 9, a to z or A to Z, case sensitive. Default ID = 0

OS (3 characters) = Operating system, 001 to 999

N (3 characters) = Message number

STX = Start-of-Text Character

CR LF = Carriage Return + Line Feed

LINE 2

S WA_tr_h1_h2_h3_h4_flags CR LF

where

S (1 character) = detection status:

0 = No significant backscatter

1 = One cloud base detected

2 = Two cloud bases detected

3 = Three cloud bases detected

4 = Four cloud bases detected

5 = Full obscuration determined but no cloud base detected

6 = Some obscuration detected but determined to be transparent

/ = Raw data input to algorithm missing or suspect

WA (1 character) = Warning or alarm status:

0 = No alarm or warning

W = Warning

A = Alarm

tr (3 characters) = Window transmission, %

h1 (5 characters) = 1st Height

If detection status is 1, 2, 3, or 4 h1 = Lowest cloud base reported

If detection status is 5 h1 = Vertical visibility as calculated

If detection status is 0 or 6 h1 = /////

h2 (5 characters) = 2nd Height

If detection status is 2, 3, or 4 h2 = Second cloud base reported

If detection status is 5 h2 = Highest signal received

If detection status is 0, 1, or 6 h2 = /////

h3 (5 characters) = 3rd Height

If detection status is 3 or 4 h3 = Third cloud base reported

If detection status is 0, 1, 2, 5, or 6 h3 = /////

h4 (5 characters) = 4th Height

If detection status is 4 h4 = Fourth cloud base reported

If detection status is 0, 1, 2, 3, or 5 h4 = /////

6.3.3 MESSAGE 003 (no profile, sky condition)

Example message line outputs

```
CS0001003
10 091 00828 ///// ///// ///// 8000000000000
99 //// 0 //// 0 //// 0 //// 0 ////
f62a
```

LINE 1

SOH CS ID OS N STX CR LF

where

SOH = Start-of-Heading character

CS = Always CS

ID (1 character) = A single character, 0 to 9, a to z or A to Z, case sensitive. Default ID = 0

OS (3 characters) = Operating system, 001 to 999

N (3 characters) = Message number

STX = Start-of-Text Character

CR LF = Carriage Return + Line Feed

LINE 2

S WA_tr_h1_h2_h3_h4_flags CR LF

where

S (1 character) = detection status:

0 = No significant backscatter

1 = One cloud base detected

2 = Two cloud bases detected

3 = Three cloud bases detected

4 = Four cloud bases detected

5 = Full obscuration determined but no cloud base detected

6 = Some obscuration detected but determined to be transparent

/ = Raw data input to algorithm missing or suspect

WA (1 character) = Warning or alarm status:

0 = No alarm or warning

W = Warning

A = Alarm

tr (3 characters) = Window transmission, %

h1 (5 characters) = 1st Height

If detection status is 1, 2, 3, or 4 h1 = Lowest cloud base reported

If detection status is 5 h1 = Vertical visibility as calculated

If detection status is 0 or 6 h1 = /////

h2 (5 characters) = 2nd Height

If detection status is 2, 3, or 4 h2 = Second cloud base reported

If detection status is 5 h2 = Highest signal received

If detection status is 0, 1, 5, or 6 h2 = /////

h3 (5 characters) = 3rd Height

If detection status is 3 or 4 h3 = Third cloud base reported

If detection status is 0, 1, 2, 5, or 6 h3 = /////

h4 (5 characters) = 4th Height

If detection status is 4 h4 = Fourth cloud base reported

If detection status is 0, 1, 2, 3, or 5 h4 = /////

flags (12 characters in 3 groups of 4) = Alarm or warning information.

Refer to Message 001 for a breakdown of the flags.

CR LF = Carriage Return and Line Feed

LINE 3

_d_h1__d2_h2__d3_h3__d4_h4__d5_h5 CR LF

(note spaces)

where

d (2 characters) = Data available

_0 to _8 Amount of lowest layer in oktas

_9 Vertical visibility only available

-1 No sky condition data available

99 Insufficient data

h1 (4 characters) = Height of the lowest cloud layer in 10 s of meters or 100 s of feet

d2 (1 character) = Cloud amount of the 2nd layer in oktas

h2 (4 characters) = Height of the 2nd cloud layer in 10 s of meters or 100 s of feet, if no 2nd layer is reported h2 = ////.

d3 (1 character) = Cloud amount of the 3rd layer in oktas

h3 (4 characters) = Height of the 3rd cloud layer in 10 s of meters or 100 s of feet, if no 3rd layer is reported h3 = ////.

d4 (1 character) = Cloud amount of the 4th layer in oktas

h4 (4 characters) = Height of the 4th cloud layer in 10 s of meters or 100 s of feet, if no 4th layer is reported h4 = ////.

d5 (1 character) = Cloud amount of the 5th layer in oktas

h5 (4 characters) = Height of the 5th cloud layer in 10 s of meters or 100 s of feet, if no 5th layer is reported h5 = ////.

CR LF = Carriage Return + Line Feed

NOTE:

Cloud amounts and heights cannot be reported until the SkyVUE PRO has been in operation for 30 minutes.

LINE 4

ETX CRC-16 EOT CR LF

where

ETX = End-of-Text character

CRC-16 (4 characters) = CRC-16 Checksum

EOT = End-of-Transmission character

CR LF = Carriage Return + Line Feed

6.3.4 MESSAGE 004 (profile, sky condition) — default message

Example message line outputs

```
CS0001004
10 092 00698 //// // 800000000000
99 /// 0 /// 0 /// 0 /// 0 ///
00100 05 2048 100 +40 02 0074 0070 30 000
071fc024d.....000 (Line output cropped for clarity)
6212
```

LINE 1

SOH CS ID OS N STX CR LF

where

SOH = Start-of-Heading character

CS = Always CS

ID (1 character) = A single character, 0 to 9, a to z or A to Z, case sensitive. Default ID = 0

OS (3 characters) = Operating system, 001 to 999

N (3 characters) = Message number

STX = Start-of-Text Character

CR LF = Carriage Return + Line Feed

LINE 2

S WA_tr_h1_h2_h3_h4_flags CR LF

where

S (1 character) = detection status:

0 = No significant backscatter

1 = One cloud base detected

2 = Two cloud bases detected

3 = Three cloud bases detected

4 = Four cloud bases detected

5 = Full obscuration determined but no cloud base detected

6 = Some obscuration detected but determined to be transparent

/ = Raw data input to algorithm missing or suspect

WA (1 character) = Warning or alarm status:

0 = No alarm or warning

W = Warning

A = Alarm

Tr (3 characters) = Window transmission, %

h1 (5 characters) = 1st Height

If detection status is 1, 2, 3, or 4 h1 = Lowest cloud base reported

If detection status is 5 h1 = Vertical visibility as calculated

If detection status is 0 or 6 h1 = /////

h2 (5 characters) = 2nd Height

If detection status is 2, 3, or 4 h2 = Second cloud base reported

If detection status is 5 h2 = Highest signal received

If detection status is 0, 1, or 6 h2 = /////

h3 (5 characters) = 3rd Height

If detection status is 3 or 4 h3 = Third cloud base reported

If detection status is 0, 1, 2, 5, or 6 h3 = /////

h4 (5 characters) = 4th Height

If detection status is 4 h4 = Fourth cloud base reported

If detection status is 0, 1, 2, 3, or 5 h4 = /////

flags (12 characters in 3 groups of 4) = Alarm or warning information.

Refer to Message 001 for a breakdown of the flags.

CR LF = Carriage Return + Line Feed.

LINE 3

_d_h1h1h1__d2_h2h2h2__d3_h3h3h3__d4_h4h4h4__d5_h5h5h5 CR LF

(note spaces)

where

d (2 characters) = Data available

_0 to _8 Amount of lowest layer in oktas

_9 Vertical visibility only available

-1 No sky condition data available

99 Insufficient data

h1 (4 characters) = Height of the lowest cloud layer in 10 s of meters or 100 s of feet

d2 (1 character) = Cloud amount of the 2nd layer in oktas

h2 (4 characters) = Height of the 2nd cloud layer in 10s of meters or 100 s of feet, if no 2nd layer is reported h2 = /////.

d3 (1 character) = Cloud amount of the 3rd layer in oktas

h3 (4 characters) = Height of the 3rd cloud layer in 10s of meters or 100s of feet, if no 3rd layer is reported h3 = /////.

d4 (1 character) = Cloud amount of the 4th layer in oktas

h4 (4 characters) = Height of the 4th cloud layer in 10 s of meters or 100s of feet, if no 4th layer is reported h4 = /////.

d5 (1 character) = Cloud amount of the 5th layer in oktas

where

ETX = End-of-Text character

CRC-16 (4 characters) = CRC-16 Checksum

EOT = End-of-Transmission character

CR LF = Carriage Return + Line Feed

6.3.5 MESSAGE 005 (no profile, sky condition, mixing layer heights)

Only available if an unlock key is entered ([Locked features](#) (p. 66))

Example message line outputs

```
CS0001005
10 092 00499 // // // // 8000000000000
99 // // 0 // // 0 // // 0 // // 0 // //
// // // // // // // // // // // // // //
b4b6
```

LINE 1

SOH CS ID OS N STX CR LF

where

SOH = Start-of-Heading character

CS = Always CS

ID (1 character) = A single character, 0 to 9, a to z, or A to Z, case sensitive. Default ID = 0

OS (3 characters) = Operating system, 001 to 999

N (3 characters) = Message number

STX = Start-of-Text Character

CR LF= Carriage Return + Line Feed

LINE 2

S WA_tr_h1_h2_h3_h4_flags CR LF

where

S (1 character) = detection status:

0 = No significant backscatter

1 = One cloud base detected

2 = Two cloud bases detected

3 = Three cloud bases detected

4 = Four cloud bases detected

5 = Full obscuration determined but no cloud base detected
6 = Some obscuration detected but determined to be transparent
/ = Raw data input to algorithm missing or suspect

WA (1 character) = Warning or alarm status:

0 = No alarm or warning

W = Warning

A = Alarm

tr (3 characters) = Window transmission, %

h1 (5 characters) = 1st Height

If detection status is 1, 2, 3, or 4 h1 = Lowest cloud base reported

If detection status is 5 h1 = Vertical visibility as calculated

If detection status is 0 or 6 h1 = /////

h2 (5 characters) = 2nd Height

If detection status is 2, 3, or 4 h2 = Second cloud base reported

If detection status is 5 h2 = Highest signal received

If detection status is 0, 1, 5, or 6 h2 = /////

h3 (5 characters) = 3rd Height

If detection status is 3 or 4 h3 = Third cloud base reported

If detection status is 0, 1, 2, 5, or 6 h3 = /////

h4 (5 characters) = 4th Height

If detection status is 4 h4 = Fourth cloud base reported

If detection status is 0, 1, 2, 3, 5, or 6 h4 = /////

flags (12 characters in 3 groups of 4) = Alarm or warning information.

Refer to Message 001 for a breakdown of the flags.

CR LF = Carriage Return and Line Feed

LINE 3

d_h1__d2_h2__d3_h3__d4_h4__d5_h5 CR LF

(note spaces)

where

d (2 characters) = Data available

_0 to _8 Amount of lowest layer in oktas

_9 Vertical visibility only available

-1 No sky condition data available

99 Insufficient data

h1 (4 characters) = Height of the lowest cloud layer in 10 s of meters or 100 s of feet

d2 (1 character) = Cloud amount of the 2nd layer in oktas

h2 (4 characters) = Height of the 2nd cloud layer in 10 s of meters or 100s of feet, if no 2nd layer is reported h2 = ////.

d3 (1 character) = Cloud amount of the 3rd layer in oktas

h3 (4 characters) = Height of the 3rd cloud layer in 10 s of meters or 100 s of feet, if no 3rd layer is reported h3 = ////.

d4 (1 character) = Cloud amount of the 4th layer in oktas

h4 (4 characters) = Height of the 4th cloud layer in 10 s of meters or 100ss of feet, if no 4th layer is reported h4 = ////.

d5 (1 character) = Cloud amount of the 5th layer in oktas

h5 (4 characters) = Height of the 5th cloud layer in 10,s of meters or 100 s of feet, if no 5th layer is reported h5h = ////.

CR LF= Carriage Return + Line Feed

NOTE:

The SkyVUE PRO must be operating for 30 minutes before cloud amounts and heights are reported.

LINE 4

mh1_q1_mh2_q2_ mh3_q3 CR LF

where

mh1 (5 characters) = height of the 1st MLH in meters or feet

q1 (5 characters) = quality parameter of the 1st MLH

mh2 (5 characters) = height of the 2nd MLH in meters or feet

q2 (5 characters) = quality parameter of the 2nd MLH

mh3 (5 characters) = height of the 3rd MLH in meters or feet

q3 (5 characters) = quality parameter of the 3rd MLH

If there are no mixing layers detected, or less than 3, then missing data is shown as /////. If the MLH option is not activated then all fields in line 4 are /////.

LINE 5

ETX CRC-16 EOT CR LF

where

ETX = End-of-Text character

CRC-16 (4 characters) = CRC-16 Checksum

EOT= End-of-Transmission character
CR LF= Carriage Return + Line Feed

6.3.6 MESSAGE 006 (profile, sky condition, mixing layer heights)

Only available if a key is entered (see [Locked features](#) (p. 66))

Example message line outputs

```
CS0001006  
10 095 01732 ///// ///// ///// 8000000000000  
99 //// 0 //// 0 //// 0 //// 0 ////  
00100 05 2048 100 +40 02 0054 0070 30 000  
///// ///// ///// ///// ///// /////  
04ae3015fe.....0000 (Line output message cropped for clarity)  
fe91
```

LINE 1

OH CS ID OS N STX CR LF

where

SOH = Start-of-Heading character

CS = Always CS

ID (1 character) = A single character, 0 to 9, a to z, or A to Z, case sensitive. Default ID = 0

OS (3 characters) = Operating system, 001 to 999

N (3 characters) = Message number

STX = Start-of-Text Character

CR LF = Carriage Return + Line Feed

LINE 2

S WA_tr_h1_h2_h3_h4_flags CR LF

where

S (1 character) = detection status:

0 = No significant backscatter

1 = One cloud base detected

2 = Two cloud bases detected

3 = Three cloud bases detected

4 = Four cloud bases detected

5 = Full obscuration determined but no cloud base detected
6 = Some obscuration detected but determined to be transparent
/ = Raw data input to algorithm missing or suspect

WA (1 character) = Warning or alarm status:

0 = No alarm or warning

W = Warning

A = Alarm

tr (3 characters) = Window transmission, %

h1 (5 characters) = 1st Height

If detection status is 1, 2, 3, or 4 h1 = Lowest cloud base reported

If detection status is 5 h1 = Vertical visibility as calculated

If detection status is 0 or 6 h1 = /////

h2 (5 characters) = 2nd Height

If detection status is 2, 3, or 4 h2 = Second cloud base reported

If detection status is 5 h2 = Highest signal received

If detection status is 0, 1, 5, or 6 h2 = /////

h3 (5 characters) = 3rd Height

If detection status is 3 or 4 h3 = Third cloud base reported

If detection status is 0, 1, 2, 5, or 6 h3 = /////

h4 (5 characters) = 4th Height

If detection status is 4 h4 = Fourth cloud base reported

If detection status is 0, 1, 2, 3, 5, or 6 h4 = /////

flags (12 characters in 3 groups of 4) = Alarm or warning information.

Refer to Message 001 for a breakdown of the flags.

CR LF = Carriage Return and Line Feed

LINE 3

_d_h1__d2_h2__d3_h3__d4_h4__d5_h5 CR LF

(note spaces)

where

d (2 characters) = Data available

_0 to _8 Amount of lowest layer in oktas

_9 Vertical visibility only available

-1 No sky condition data available

99 Insufficient data

h1 (4 characters) = Height of the lowest cloud layer in 10 s of meters or 100 s of feet

d2 (1 character) = Cloud amount of the 2nd layer in oktas

h2 (4 characters) = Height of the 2nd cloud layer in 10 s of meters or 100 s of feet, if no 2nd layer is reported h2 = ////.

d3 (1 character) = Cloud amount of the 3rd layer in oktas

h3 (4 characters) = Height of the 3rd cloud layer in 10 s of meters or 100 s of feet, if no 3rd layer is reported h3 = ////.

d4 (1 character) = Cloud amount of the 4th layer in oktas

h4 (4 characters) = Height of the 4th cloud layer in 10 s of meters or 100 s of feet, if no 4th layer is reported h4 = ////.

d5 (1 character) = Cloud amount of the 5th layer in oktas

h5 (4 characters) = Height of the 5th cloud layer in 10 s of meters or 100 s of feet, if no 5th layer is reported h5 = ////.

CR LF = Carriage Return + Line Feed

NOTE:

The SkyVUE PRO must be operating for 30 minutes before cloud amounts and heights are reported.

LINE 4

scale_res_n_energy_lt_ti_bl_pulse_rate_sum CR LF

where

scale (5 characters) = Scale parameter, %, 0 to 99999. 100% is default res (2 characters) = Backscatter profile resolution in meters.

n (4 characters) = Profile length

energy (3 characters) = Laser pulse energy, %.

lt (3 characters including leading +/-) = Laser temperature, degrees C

ti (2 characters) = Total tilt angle, degrees

bl (4 characters) = Background light, millivolts at internal ADC input (0 to 2500)

pulse (4 characters) = Pulse quantity x 1000 (0000 to 9999)

rate (2 characters) = Sample rate, MHz, (00 to 99)

sum = (3 characters) Sum of detected and normalized backscatter, 0 to 999. Multiplied by scaling factor times 10^4 . At scaling factor 100 the SUM range 0 to 999 corresponds to integrated backscatter 0 to 0. srad^{-1}

CR LF = Carriage Return + Line Feed

LINE 5

mh1_q1_mh2_q2_ mh3_q3 CR LF

where

mh1 (5 characters) = height of the 1st MLH in meters or feet

q1 (5 characters) = quality parameter of the 1st MLH

mh2 (5 characters) = height of the 2nd MLH in meters or feet

q2 (5 characters) = quality parameter of the 2nd MLH

mh3 (5 characters) = height of the 3rd MLH in meters or feet

q3 (5 characters) = quality parameter of the 3rd MLH

If there are no mixing layers detected, or less than 3, then missing data is shown as /////. If the MLH option is not activated then all fields in Line 5 are /////.

LINE 6

SSSSSSSSSSSSSSSSSSSSSSSSSSSSSSSSSSSSSS.....(2048 x 5 bytes) CR LF

The two-way attenuated normalized backscatter profile ([Backscatter profile reporting](#) (p. 7))

CR LF= Carriage Return + Line Feed

LINE 7

ETX CRC-16 EOT CR LF

where

ETX = End-of-Text character

CRC-16 (4 characters) = CRC-16 Checksum

EOT = End-of-Transmission character

CR LF = Carriage Return + Line Feed

6.4 CL31 messages

6.4.1 MESSAGES 101 - 106, (CL31 MESSAGE 1)

Example message 101 line outputs

```
CL017011
10 01128 // // // // 00000000E080
00100 10 0770 100 +40 094 02 0032 L0112HN30 000
036B200CC1002.....EEFFB3F      (Line output cropped for clarity)
e515
```

LINE 1

SOH CL ID OS 1 Samples STX CR LF

where

SOH = Start-of-Heading character

CL = Always CL

ID = A single character, 0 to 9, a to z or A to Z, case sensitive. Default ID = 0

OS = Operating system, 100 to 999

1 = Always 1

Samples = backscatter resolution and number of samples

1 = MESSAGE 101, 10 m x 770 samples, range 7700 m

2 = MESSAGE 102, 20 m x 385 samples, range 7700 m

3 = MESSAGE 103, 5 m x 1500 samples, range 7500 m

4 = MESSAGE 104, 5 m x 770 samples, range 3850 m

5 = MESSAGE 105, no backscatter profile

0 = MESSAGE 106, extended range, 5 m x 2048 samples, range 10,240 m

STX = Start-of-Text Character

CR LF = Carriage Return + Line Feed

LINE 2

S WA_h1_h2_h3_flags CR LF

6.4.2 MESSAGE 005 (no profile, sky condition, mixing layer heights)

Available only when a key is entered (see [Locked features](#) (p. 66))

LINE 1

SOH CS ID OS N STX CR LF

where

SOH = Start-of-Heading character

CS = Always C

ID (1 character) = A single character, 0 to 9, a to z or A to Z, case sensitive. Default ID = 0

OS (3 characters) = Operating system, 001 to 999

N (3 characters) = Message number

STX = Start-of-Text Character

CR LF = Carriage Return + Line Feed

LINE 2

S WA_tr_h1_h2_h3_h4_flags"

where

S (1 character) = detection status:

0 = No significant backscatter

1 = One cloud base detected

2 = Two cloud bases detected

3 = Three cloud bases detected

4 = Full obscuration determined but no cloud base detected

5 = Some obscuration detected but determined to be transparent

/ = Raw data input to algorithm missing or suspect

WA (1 character) = Warning or alarm status:

0 = No alarm or warning

W = Warning

A = Alarm

h1 (5 characters) = 1st Height

If detection status is 1, 2, 3 or 4 h1 = Lowest cloud base reported

If detection status is 5 h1 = Vertical visibility as calculated

If detection status is 0 or 6 h1 = /////

h2 (5 characters) = 2nd Height

If detection status is 2 or 3 h2 = Second cloud base reported

If detection status is 4 h2 = Highest signal received

If detection status is 0, 1, or 5 h2 = /////

h3 (5 characters) = 3rd Height

If detection status is 3 h3 = Third cloud base reported

If detection status is 0, 1, 2, 4, or 5 h3 = /////

flags (12 characters) = Alarm or warning information (refer to [Table 6-4](#) (p. 91), [Table 6-5](#) (p. 92), and [Table 6-6](#) (p. 92) for a breakdown of flags)

Table 6-4: Most significant alarm word for CS31 messages	
Bit ¹	Description
8000 XXXX XXXX	Transmitter shut-off
4000 XXXX XXXX	Transmitter failure
2000 XXXX XXXX	Receiver failure
1000 XXXX XXXX	Reserved for future use
0800 XXXX XXXX	Reserved for future use
0400 XXXX XXXX	Memory error
0200 XXXX XXXX	Light path obstruction
0100 XXXX XXXX	Receiver saturation
0080 XXXX XXXX	Reserved for future use
0040 XXXX XXXX	Reserved for future use
0020 XXXX XXXX	Reserved for future use
0010 XXXX XXXX	Reserved for future use
0008 XXXX XXXX	Reserved for future use
0004 XXXX XXXX	Reserved for future use
0002 XXXX XXXX	Reserved for future use
0001 XXXX XXXX	Ceilometer engine board failure

¹ Alarm words are sum of error bits.

Table 6-5: Middle alarm word for CS31 messages

Bit ¹	Description
XXXX 8000 XXXX	Window contamination
XXXX 4000 XXXX	Battery voltage low
XXXX 2000 XXXX	Transmitter expires
XXXX 1000 XXXX	High humidity
XXXX 0800 XXXX	Reserved for future use
XXXX 0400 XXXX	Blower failure
XXXX 0200 XXXX	Reserved for future use
XXXX 0100 XXXX	Humidity sensor failure
XXXX 0080 XXXX	Heater fault
XXXX 0040 XXXX	High background radiance
XXXX 0020 XXXX	Ceilometer engine board failure
XXXX 0010 XXXX	Reserved for future use
XXXX 0008 XXXX	Laser monitor failure
XXXX 0004 XXXX	Receiver warning
XXXX 0002 XXXX	Tilt beyond limit set by user, default 45 degrees
XXXX 0001 XXXX	Reserved for future use

¹ Alarm words are sum of error bits.

Table 6-6: Least significant alarm word for CS31 messages

Bit ¹	Description
XXXX XXXX 8000	Blower is on
XXXX XXXX 4000	Blower heater is on
XXXX XXXX 2000	Internal heater is on
XXXX XXXX 1000	Working from battery
XXXX XXXX 0800	Reserved for future use
XXXX XXXX 0400	Self test in progress

Table 6-6: Least significant alarm word for CS31 messages	
Bit ¹	Description
XXXX XXXX 0200	Reserved for future use
XXXX XXXX 0100	Reserved for future use
XXXX XXXX 0080	Units are meters if on, else feet
XXXX XXXX 0040	Reserved for future use
XXXX XXXX 0020	Polling mode is on
XXXX XXXX 0010	Reserved for future use
XXXX XXXX 0008	Reserved for future use
XXXX XXXX 0004	Reserved for future use
XXXX XXXX 0002	Reserved for future use
XXXX XXXX 0001	Reserved for future use
¹ Alarm words are sum of error bits.	

CR LF = Carriage Return + Line Feed

LINE 3

scale_res_n_energy_lt_tr_ti_bl_L0112HN15_sum CR LF

where,

scale (5 characters) = Scale parameter, %, 0 to 99999. 100% is typical

res (2 characters) = Backscatter profile resolution in meters

n (4 characters) = Profile length 385, 770, 1400, or 1500 samples

energy (3 characters) = Laser pulse energy, %

lt (3 characters including leading +/-) = Laser temperature, degrees C

tr (3 characters) = Window transmission, %

ti (2 characters) = Total tilt angle, degrees

bl (4 characters) = Background light, millivolts at internal ADC input (0 to 2500)

"L0112HN15" (9 characters) = Reserved, defaults shown

sum = (3 characters) Sum of detected and normalized backscatter, 0 to 999.

CR LF = Carriage Return + Line Feed

NOTE:

This line is omitted from message 105.

LINE 4

SSSSSSSSSSSSSSSSSSSSSSSSSSSSSSSSSSSSSS.....(5 x 770 bytes) CR LF

The two-way attenuated normalized backscatter profile; see [Backscatter profile reporting](#) (p. 7).

CR LF = Carriage Return + Line Feed

NOTE:

This line is omitted from message 105.

LINE 5

ETX CRC-16 EOT CR LF

where

ETX = End-of-Text character

CRC-16 (4 characters) = CRC-16 Checksum

EOT = End-of-Transmission character

CR LF = Carriage Return + Line Feed

6.4.3 MESSAGES 107 - 112, CL31 Message 2

Example message 107 line outputs

```

CL017021
10 01407 ///// ///// 00000000E080
99 /// 0 /// 0 /// 0 /// 0 ///
00100 10 0770 100 +40 095 02 0031 L0112HN30 000
03301009.....027F      (Line output cropped for clarity)
e669
```

LINE 1

SOH CL ID OS 2 Samples STX CR LF

where

SOH = Start-of-Heading character

CL = Always CL

ID = A single character, 0 to 9, a to z or A to Z, case sensitive. Default ID = 0

OS = Operating system, 100 to 999

2 = Always 2

Samples = backscatter resolution and number of samples

1 = MESSAGE 107, 10 m x 770 samples, range 7700 m

2 = MESSAGE 108, 20 m x 385 samples, range 7700 m

3 = MESSAGE 109, 5 m x 1500 samples, range 7500 m

4 = MESSAGE 110, 5 m x 770 samples, range 3850 m

5 = MESSAGE 111, no backscatter profile

0 = MESSAGE 112, extended range, 5 m x 2048 samples, range 10240 m

STX = Start-of-Text Character

CR LF = Carriage Return + Line Feed

LINE 2

S WA_h1_h2_h3_flags CR LF

where

S (1 character) = detection status:

0 = No significant backscatter

1 = One cloud base detected

2 = Two cloud bases detected

3 = Three cloud bases detected

4 = Full obscuration determined but no cloud base detected

5 = Some obscuration detected but determined to be transparent

/ = Raw data input to algorithm missing or suspect

WA (1 character) = Warning or alarm status:

0 = No alarm or warning

W = Warning

A = Alarm

h1 (5 characters) = 1st Height

If detection status is 1, 2, or 3 h1 = Lowest cloud base reported

If detection status is 4 h1 = Vertical visibility as calculated

If detection status is 0 or 5 h1 = /////

h2 (5 characters) = 2nd Height

If detection status is 2 or 3 h2 = Second cloud base reported

If detection status is 4 h2 = Highest signal received

If detection status is 0, 1, or 5 h2 = /////

h3 (5 characters) = 3rd Height

If detection status is 3 h3 = Third cloud base reported

If detection status is 0, 1, 2, 4, or 5 h3 = /////

flags (12 characters) = Alarm or warning information.

Same as for messages 101 to 106

CR LF = Carriage Return + Line Feed

LINE 3

__d_h1h1h1__d2_h2h2h2__d3_h3h3h3__d4_h4h4h4__d5_h5h5h5 CR LF

(note spaces)

where

d (1 character) = Data available

0 to 8 Amount of lowest layer in oktas

9 Vertical visibility only available

-1 No sky condition data available

99 Insufficient data

h1h1h1 (3 characters) = Height of the lowest cloud layer in 10 s of meters or 100 s of feet

d2 (1 character) = Cloud amount of the 2nd layer in oktas

h2h2h2 (3 characters) = Height of the 2nd cloud layer in 10 s of meters or 100 s of feet, if no 2nd layer is reported h2h2h2 = ///.

d3 (1 character) = Cloud amount of the 3rd layer in oktas

h3h3h3 (3 characters) = Height of the 3rd cloud layer in 10 s of meters or 100 s of feet, if no 3rd layer is reported h3h3h3 = ///.

d4 (1 character) = Cloud amount of the 4th layer in oktas

h4h4h4 (3 characters) = Height of the 4th cloud layer in 10 s of meters or 100 s of feet, if no 4th layer is reported h4h4h4 = ///.

d5 (1 character) = Cloud amount of the 5th layer in oktas

h5h5h5 (3 characters) = Height of the 5th cloud layer in 10 s of meters or 100 s of feet, if no 5th layer is reported h5h5h5 = ///.

CR LF = Carriage Return + Line Feed

NOTE:

Cloud amount and height cannot be reported until the SkyVUE PRO has been operating for 30 minutes.

6.5 CT25K messages

6.5.1 MESSAGE 113, CT25K Data Message No. 1

Example message line outputs

CT02010

20 01333 01523 ///// 00000F00

LINE 1

SOH CT ID 20 10 STX CR LF

where

SOH = Start-of-Heading character

CT = Always CT

ID (1 character) = Unit number 0 to 9, A to Z (capitals only) Default ID = 0

20 = Always 20

10 = Always 10

STX = Start-of-Text Character

CR LF = Carriage Return + Line Feed

LINE 2

S WA_h1_h2_h3_flags CR LF

where

S (1 character) = detection status:

0 = No significant backscatter

1 = One cloud base detected

2 = Two cloud bases detected

3 = Three cloud bases detected

4 = Full obscuration determined but no cloud base detected

5 = Some obscuration detected but determined to be transparent

/ = Raw data input to algorithm missing or suspect

WA (1 character) = Warning or alarm status:

0 = No alarm or warning

W = Warning

A = Alarm

h1 (5 characters) = 1st Height

If detection status is 1, 2, or 3 h1 = Lowest cloud base reported

If detection status is 4 h1 = Vertical visibility as calculated

If detection status is 0 or 5 h1 = /////

h2 (5 characters) = 2nd Height

If detection status is 2 or 3 h2 = Second cloud base reported

If detection status is 4 h2 = Height of highest signal detected

If detection status is 0, 1, or 5 h2 = /////

h3 (5 characters) = 3rd Height

If detection status is 3 h3 = Third cloud base reported

If detection status is 0, 1, 2, 4, or 5 h3 = /////

flags (8 characters) = Alarm or warning information 4-byte hex coded

Bit¹	Description
8000 XXXX	Transmitter shut-off
4000 XXXX	Transmitter failure
2000 XXXX	Receiver failure
1000 XXXX	DSP, voltage or memory failure
0800 XXXX	Reserved for future use
0400 XXXX	Reserved for future use
0200 XXXX	Reserved for future use
0100 XXXX	Reserved for future use
0080 XXXX	Window contaminated
0040 XXXX	Battery low
0020 XXXX	Transmitter expire warning
0010 XXXX	Heater or humidity sensor failure
0008 XXXX	High radiance warning, also XXXX 0004
0004 XXXX	DSP, receiver, or laser monitor failure warning
0002 XXXX	Relative humidity > 85 %
0001 XXXX	Light path obstruction, receiver saturation or receiver failure

¹ Alarm words are sum of error bits.

Table 6-8: Second alarm word for CT25K messages	
Bit ¹	Description
XXXX 8000	Blower failure
XXXX 4000	Reserved for future use
XXXX 2000	Reserved for future use
XXXX 1000	Reserved for future use
XXXX 0800	Blower on
XXXX 0400	Blower heater on
XXXX 0200	Internal heater on
XXXX 0100	Units meters if on, feet if off
XXXX 0080	Polling mode on
XXXX 0040	Working from battery
XXXX 0020	Always 0
XXXX 0010	Always 0
XXXX 0008	Tilt beyond limit set by user, default 45 degrees
XXXX 0004	High radiance warning, also 0008 XXXX
XXXX 0002	Reserved for future use
XXXX 0001	Reserved for future use
¹ Alarm words are sum of error bits.	

CR LF = Carriage Return + Line Feed

LINE 3

ETX CR LF

ETX = End-of-Text Character

CR LF = Carriage Return + Line Feed

6.5.2 MESSAGE 114, CT25K Data Message No. 6

Example message line outputs

```
CT02060  
10 01767 ///// ///// 00000F00  
99 /// 0 /// 0 /// 0 ///
```

LINE 1

SOH CT ID 20 60 STX CR LF

where

SOH = Start-of-Heading character

CT = Always CT

ID (1 character) = Unit number 0 to 9, A to Z (capitals only) Default ID = 0

20 = always 20

60 = always 60

STX = Start-of-Text Character

CR LF = Carriage Return + Line Feed

LINE 2

S WA_h1_h2_h3_flags CR LF

where

S (1 character) = detection status:

0 = No significant backscatter

1 = One cloud base detected

2 = Two cloud bases detected

3 = Three cloud bases detected

4 = Full obscuration determined but no cloud base detected

5 = Some obscuration detected but determined to be transparent

/ = Raw data input to algorithm missing or suspect

WA (1 character) = Warning or alarm status:

0 = No alarm or warning

W = Warning

A = Alarm

h1 (5 characters) = 1st Height

If detection status is 1, 2, or 3 h1 = Lowest cloud base reported

If detection status is 4 h1 = Vertical visibility as calculated

If detection status is 0 or 5 h1 = /////

h2 (5 characters) = 2nd Height

If detection status is 2 or 3 h2 = Second cloud base reported

If detection status is 4 h2 = Height of highest signal detected

If detection status is 0, 1, or 5 h2 = /////

h3 (5 characters) = 3rd Height

If detection status is 3 h3 = Third cloud base reported

If detection status is 0, 1, 2, 4, or 5 h3 = /////

flags (8 characters) = Alarm or warning information 4-byte hex coded

As for CT25K message 1.

CR LF = Carriage Return + Line Feed

LINE 3 (Sky CONDITION)

__d_h1h1h1__d2_h2h2h2__d3_h3h3h3__d4_h4h4h4 CR LF

(note spaces)

where

d (1 character) = Data available

0 to 8 Amount of lowest layer in oktas

9 Vertical visibility only available

-1 No sky condition data available

99 Insufficient data

h1h1h1 (3 characters) = Height of the lowest cloud layer in 10 s of meters or 100 s of feet

d2 (1 character) = Cloud amount of the 2nd layer in oktas

h2h2h2 (3 characters) = Height of the 2nd cloud layer in 10 s of meters or 100 s of feet, if no 2nd layer is reported h2h2h2 = ///.

d3 (1 character) = Cloud amount of the 3rd layer in oktas

h3h3h3 (3 characters) = Height of the 3rd cloud layer in 10 s of meters or 100 s of feet, if no 3rd layer is reported h3h3h3 = ///.

d4 (1 character) = Cloud amount of the 4th layer in oktas

h4h4h4 (3 characters) = Height of the 4th cloud layer in 10 s of meters or 100 s of feet, if no 4th layer is reported h4h4h4 = ///.

CR LF = Carriage Return + Line Feed

NOTE:

Cloud amount and height cannot be reported until the SkyVUE PRO has been operating for 30 minutes.

LINE 4

ETX CR LF

ETX = End-of-Text Character

CR LF = Carriage Return + Line Feed

7. Maintenance

7.1 General	103
7.2 Cleaning	103
7.3 Removing the cover	104
7.4 Removing the enclosure lid	105
7.5 Diagnostic LED indicators within the enclosure	105
7.6 Electrical safety testing	107

7.1 General

The SkyVUE PRO is a robust weather resistant instrument and there is no need for routine maintenance other than cleaning. The instrument performance is monitored, and any potential problems are indicated by error messages.

7.2 Cleaning

The SkyVUE PRO window will require cleaning from time to time. The frequency of required cleaning depends on the exposure of the instrument to contaminants such as salt and dust. This will vary depending on the site location. The SkyVUE PRO is capable of self diagnosing dirty lenses and will indicate in its output when the lenses are contaminated.

In any case, we suggest six monthly intervals for locations not prone to contaminants and monthly intervals for those prone to contamination (coastal, roadside or airport use). In some

cases, more frequent cleaning may be required where there are high levels of contaminants and high dependency on the instrument output.

CAUTION:

If the window requires cleaning, it is very important that only a proper lens cloth or lens tissue is used. The use of inappropriate materials to clean the windows can permanently damage or reduce their effectiveness leading to reduced performance.

Use an air duster to blow any loose dust and dirt from the window as a first step. Use a lint free lens cloth or lens tissue impregnated with a non-aggressive standard window cleaner. Clean the surface by dragging the cloth across it being careful not to apply excessive pressure.

Excessive pressure may lead to some types of contaminants scratching the window surface. Over time such scratches can lead to reduced sensitivity.

When the cowl is removed, avoid spraying the heater/fan assembly with liquids.

7.3 Removing the cover

1. Remove four screws (FIGURE 7-1 (p. 104)).

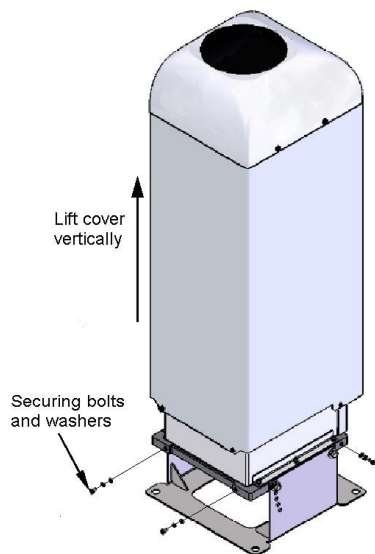

FIGURE 7-1. Removing the cover

2. Lift the cover off the base.

CAUTION:

The cover contains a flying lead used to take power to the hood heater and blower. Be careful not to trap and damage this when lifting the cover clear.

7.4 Removing the enclosure lid

1. Remove the four screws (FIGURE 7-2 (p. 105))
2. Pull the enclosure lid away from the electronic unit.

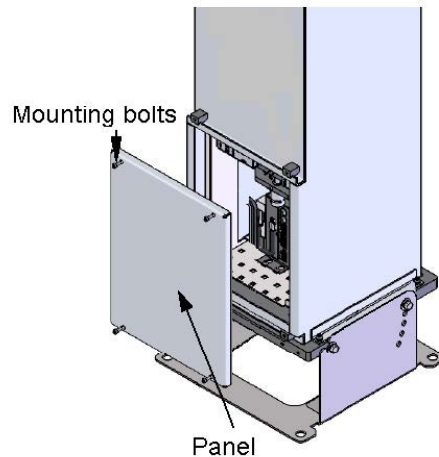

FIGURE 7-2. Removing the enclosure lid

WARNING:

Opening the access door MUST be carried out by a competent person, who has sufficient training, experience and knowledge both in electrical safety and the detail and operation of the sensor.

WARNING:

Removing the enclosure lid may expose hot surfaces.

7.5 Diagnostic LED indicators within the enclosure

The **LASER ON** and **STATUS** green LEDs are visible on the DSP (see FIGURE 7-3 (p. 106)). Their function is as follows:

LASER ON LED:

- Off = laser off
- Flashing = laser fault
- On = laser on

STATUS LED:

1 flash every 10 seconds = OK

2 flashes every 10 seconds = warning (possible degraded performance)

3 flashes every 10 seconds = alarm (measurements not possible)

The DSP **STATUS** LED provides the same function as the LED visible through the top window.

The red LED on the PSU flashes for 0.5 seconds:

Permanently on = PSU firmware fault

1 flash every 10 seconds = PSU OK

2 flashes every 10 seconds = running in battery mode

3 flashes every 10 seconds = no communications to the DSP. This takes 60 seconds to start after a communications failure.



FIGURE 7-3. Diagnostic LED indicators

The red LED on the laser module indicates:

Off = Laser off

On = Laser on

7.6 Electrical safety testing

NOTE:

If carrying out insulation tests, do not use test voltages above 300 V RMS because the sensor is designed to clamp any mains input voltages above this level. Voltage clamping can result in a false failure being detected.

Appendix A. Measurement of the attenuated backscatter profile

A.1 Initial measurement	108
A.2 Backscatter onset height detection	108
A.3 Produce attenuated backscatter output message	109

A.1 Initial measurement

- Pulse the laser and measure the backscatter at optimal gains.
- Derive the impulse response and impulse correct the backscatter signal using the inverse filter derived.
- Remove the residual offset and slope from the impulse corrected backscatter.
- Apply an overlap correction based on the known generic overlap function of the SkyVUE PRO.
- Apply the backscatter calibration constants.
- Remove the laser and electronic artefact signature. This is specific to the individual SkyVUE PRO and determined during calibration.

A.2 Backscatter onset height detection

- Filter the backscatter with 20 m (65.6 ft) and 300 m (984 ft) width filters.
- Look for a 1500 m (4921 ft) block width where the standard deviation is at a minimum for both the 20 m (65.6 ft) and 300 m (984 ft) width filtered backscatters.
- Create a detection threshold by multiplying the 20 m (65.6 ft) and 300 m (984 ft) standard deviations by a constant.
- Find the onset of backscatter height by working from the highest height bin downwards until the backscatter is above one or both of the two detection thresholds.

A.3 Produce attenuated backscatter output message

- Range correct the backscatter to produce the attenuated backscatter.
- Attenuated backscatter (output), calibrated, range corrected but not tilt corrected.
- Smooth with a 20 m (65.6 ft) width running average.
- A noise gate can be applied based on a multiple of the 20 m (65.6 ft) detection threshold — this is customer configurable.
- The lower height range bins do not gate noise until the backscatter reaches zero. This allows the full extent of mixing layers to be viewed in gating mode.

Appendix B. Cloud height calculation

The scatter profile is inverted (using the Klett inversion technique) and an extinction profile is calculated.

Cloud base heights are identified using two criteria as follows (cloud is detected if either of them is met).

Criterion 1: likely cloud bases are estimated based on increasing slope of the extinction profile of at least 7 m (22.9 ft) per bin (bin width is 5 m (16.4 ft) and an extinction threshold. This threshold is based on an extinction coefficient (EXCO) of 3, equivalent to a horizontal visibility (MOR) of 1000 m (3280 ft). This results in a number of possible cloud bases at different heights.

Criterion 2: horizontal visibility falls below an average of 4800 m (15,748 ft) over 300 m (984 ft) starting at an altitude of 1000 m (3280 ft).

To report a cloud layer above a lower one the scatter coefficient first has to fall below the extinction threshold used for cloud definitions (less a small hysteresis offset). The scatter profile must then again meet the criteria above.

If rain is detected, the sensitivity of detection is increased by a factor of 3.

To avoid many very narrow close layers being reported when they have little significance a minimum separation based on WMO reporting intervals is applied. The separation is ± 30 m (98 ft) below 1500 m (4921 ft) and 300 m (984 ft) above 1500 m (4921 ft). The lowest cloud height is used. If a thin cloud identified by Criterion 2 above is within ± 150 m (492 ft) of a cloud identified by criterion 1, then the thin cloud is ignored.

Appendix C. Sky condition algorithm description

The SkyVUE PRO sky condition algorithm follows guidance from ICAO and WMO documents¹ and is based on 30 minutes of data. For this reason, sky condition is not available for 30 minutes after power cycling the sensor, a reboot, or changing measurement parameters. The sky condition algorithm is as follows:

Each measured hit comprising the lowest cloud height, (vertical visibility + onset of backscatter) / 2 and a weighting of 1 or 2 is stored in a running half hour buffer.

The weighting is 2 for hits in the last 10 minutes and 1 for hits in the previous 20 minutes.

If >50% of the hits in the latest 10 minutes are vertical visibility, then the vertical visibility averaged over the last 10 minutes is reported. Only hits below the vertical visibility height limit set are used.

The buffer is sorted in height order and hits combined into bins with the following widths:

Height	Bin width
0 – 5000 ft (0 – 1524 m)	100 ft (30.5 m)
5000 – 15,000 ft (1524 – 4572 m)	200 ft (61 m)
15,000 – 26,250 ft (4572 – 8000 m)	500 ft (152 m)

For each bin a mean height is calculated by the following:

$$H_i = \frac{\sum(h_i w_i)}{\sum(w_i)}$$

Where w_i is the weight (1 or 2) of the hit with height h_i

Bins are then reduced. A distance (D) between adjacent bins is calculated by the following equation:

$$D = \frac{N_i N_j (H_i - H_j)^2}{N_i + N_j}$$

¹ICAO 9837 Manual on Automatic Meteorological Observing Systems at Aerodromes.
WMO – No. 306 Manual on Codes

Where N_i and N_j are the sum of hits of each bin and H_i and H_j the respective heights.

Find the pair with the minimum distance D and combine into one bin with the height of the lowest and number of hits of the combined total.

This process is repeated until 5 or less bins remain. These are now taken as cloud layers.

Finally, if cloud layers are closer than the distances below, then they are merged with the height of the lowest and combined total number of hits.

Height range	Distance (D)
Height \leq 300 m (1000 ft)	\leq 90 m (300 ft)
300 m $<$ Height \leq 900 m (1000 ft $<$ Height \leq 3000 ft)	\leq 120 m (400 ft)
900 m $<$ Height \leq 1500 m (3000 ft $<$ Height \leq 5000 ft)	\leq 180 m (600 ft)
1500 m $<$ Height \leq 2400 m (5000 ft $<$ Height \leq 8000 ft)	\leq 300 m (1000 ft)
Height $>$ 2400 m (8000 ft)	\leq 480 m (1600 ft)

Weights per layer are used to calculate number of oktas per layer.

If the total possible is W_{max} , then the cover is $(W_i/W_{max}) \times 8$.

Cloud amounts are rounded up to the next highest whole oktas.

For layers above the lowest this is based on the maximum possible weights. If the lower layers have W_1 hits and the next layer has W_2 hits, then the cover of the higher layer is given by:

$$(W_2/(W_{max}-W_1)) \times 8$$

For example, taking weighting into account, if lower layers of cloud only allow 4/8 of clear sky above and the cover is 2/8 out of those 4/8, then the layer above is taken as 4/8.

Finally, only layers meeting the following criteria are reported:

Layer 1 \geq 1/33 oktas

Layer 2 \geq 3 oktas

Layer 3 \geq 5 oktas

Layer 4 \geq 7 oktas

Layer 5 \geq 7 oktas

Any layer $>$ $(8 - 1/33)$ oktas is reported as 8 oktas

Appendix D. Replacing the SkyVUE PRO PSU

The Power Supply Unit (PSU) can be replaced in the SkyVUE PRO as follows:

1. Disconnect the power to the SkyVUE PRO and open the housing.
2. Disconnect all the plugs from the PSU including the battery.
3. Use a 3 mm ball-end hexagonal-key to remove the two M4 x 12 socket head screws on the chassis plate that are on the bent-up tabs on the left and right hand sides.
4. Pull the PSU forward removing the PSU and battery carrier.
5. Loosen the four screws holding the PSU in place and slide off the PSU.
6. Re-insert the new PSU and push back into position.
7. Replace the two screws on the chassis plate.
8. Re-attach the cable plugs into the correct sockets on the new PSU ensuring that each is connected properly.
9. Ensure that the battery (if used) is reconnected to the PSU.

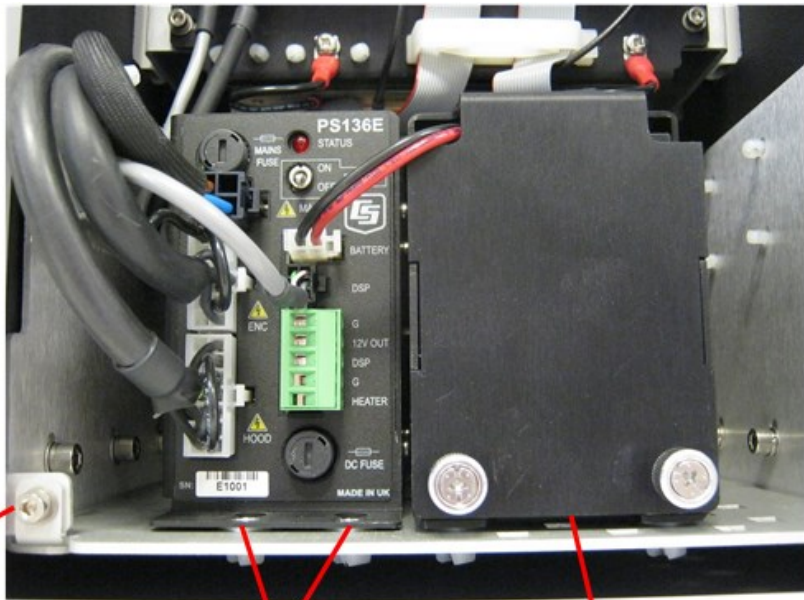

Chassis plate M4 x 12
socket head screw
(one of two shown)

PSU retaining screws.
Two further screws are located at
the rear of the PSU.

Battery carrier

Appendix E. SkyVUE PRO Laser/APD module replacement

Basic procedure:

1. Isolate the SkyVUE PRO from AC mainspower.
2. Remove the outer enclosure.
3. Remove the access door using the supplied key.
4. Disconnect the cables from the Power Supply Unit (PSU) including the battery.

NOTE:

It is very important to disconnect the battery from the SkyVUE PRO to ensure that the laser is not powered.

5. Unscrew the two securing screws from the PSU chassis plate so it can be pulled out to gain better access to the Laser and APD module.
6. Now the Laser module and avalanche photo diode (APD) module will be visible.

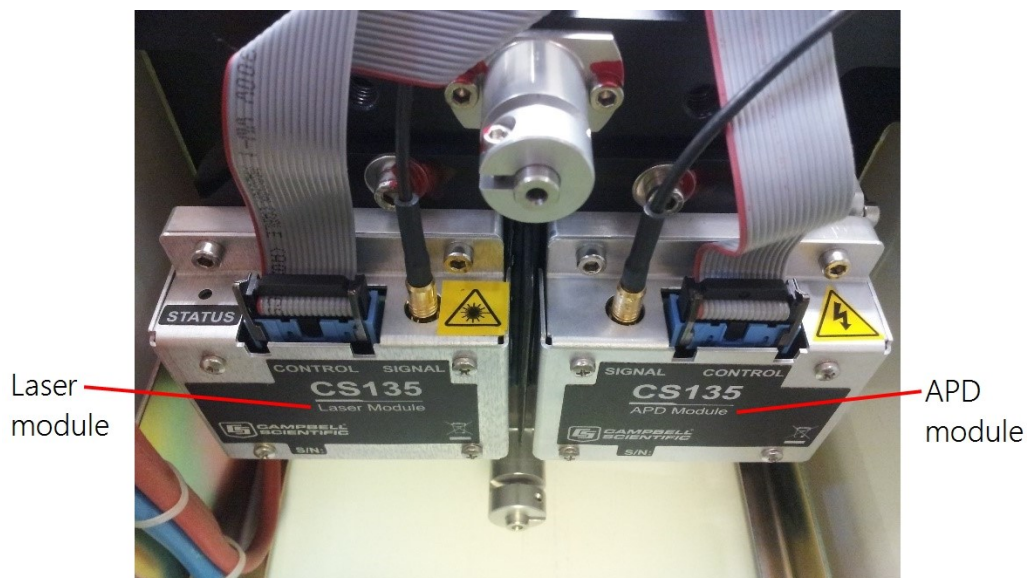

7. Disconnect the ribbon cable and SMB connector from the module that is being replaced. To avoid damage only pull the gold metal part of the SMB connector.

8. The laser module and APD module have four M4 x 14 mm long socket cap screws with a plain and spring washer securing them. Two of the screws are visible and the other two cannot be seen; they are at the back and directly across from the front screws. Feel for these screws or use a mirror to help locate and loosen them.

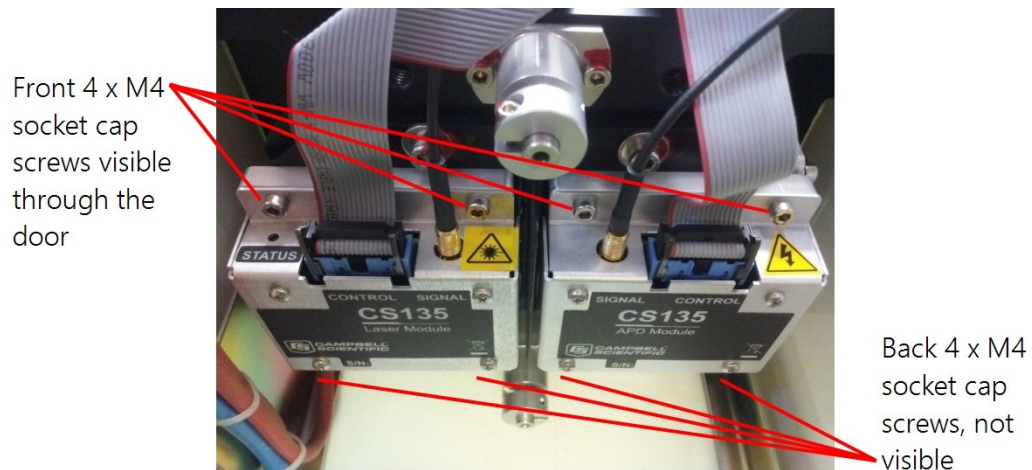

WARNING:
Do not loosen any other screws.

WARNING:

Do not replace screws with different length screws.

9. Remove any protective film from the filters of the new APD and laser modules before mounting them.
10. Once the screws have been removed pull the module off the locating pins. Fit the new module by pushing it onto the locating pins and then re-assembling, in reverse order, using the original screws, spring washers and plain washers.
11. Reconnect the ribbon cable and SMB connector to the module before closing and securing the access door.

NOTE:

Make sure the module sits flat against the plate before tightening the four screws.

Appendix F. SkyVUE PRO TOP board replacement

1. Isolate the SkyVUE PRO from AC mainspower.
2. Remove the outer enclosure.
3. Remove the access door using the supplied key.
4. Disconnect the cables from the Power Supply Unit (PSU) including the battery.

NOTE:

It is very important to disconnect the battery from the SkyVUE PRO to ensure that the laser is not powered.

5. Use a 4 mm ball-end hexagon-key to remove 3 screws from each side of the inner enclosure as shown.

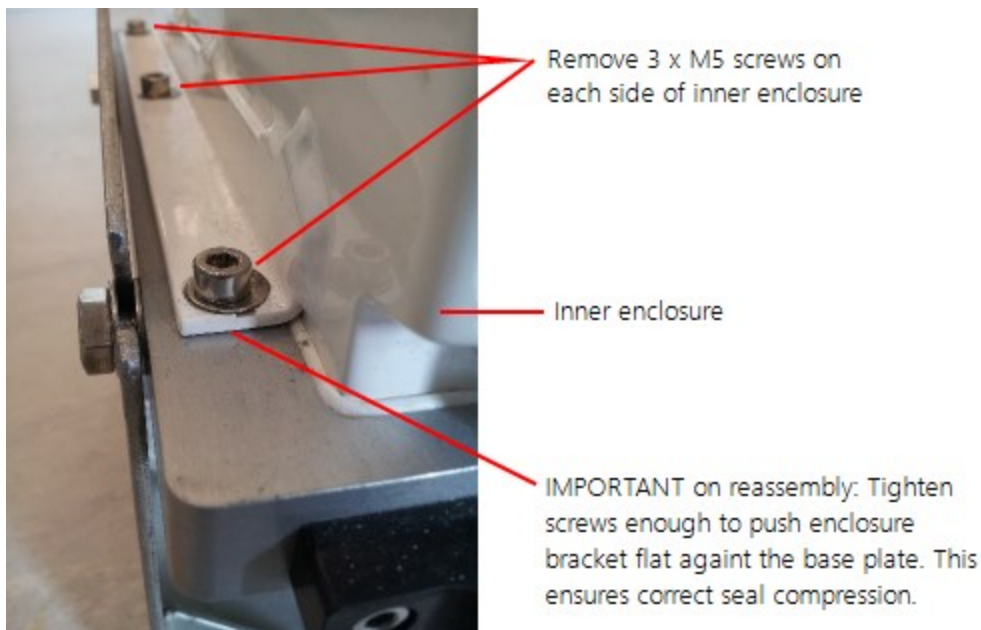

6. Use antistatic precautions. The electronics are sensitive to static discharge.

- Carefully lift the inner enclosure upward until it is clear of the lens and TOP board assembly as shown.

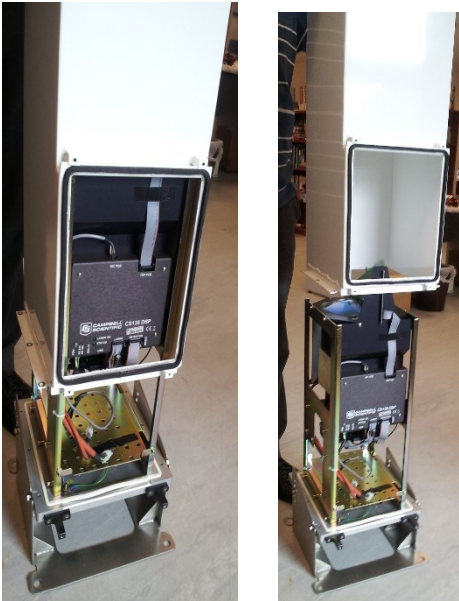

This will expose the lens and the TOP board. Do not touch the lens.

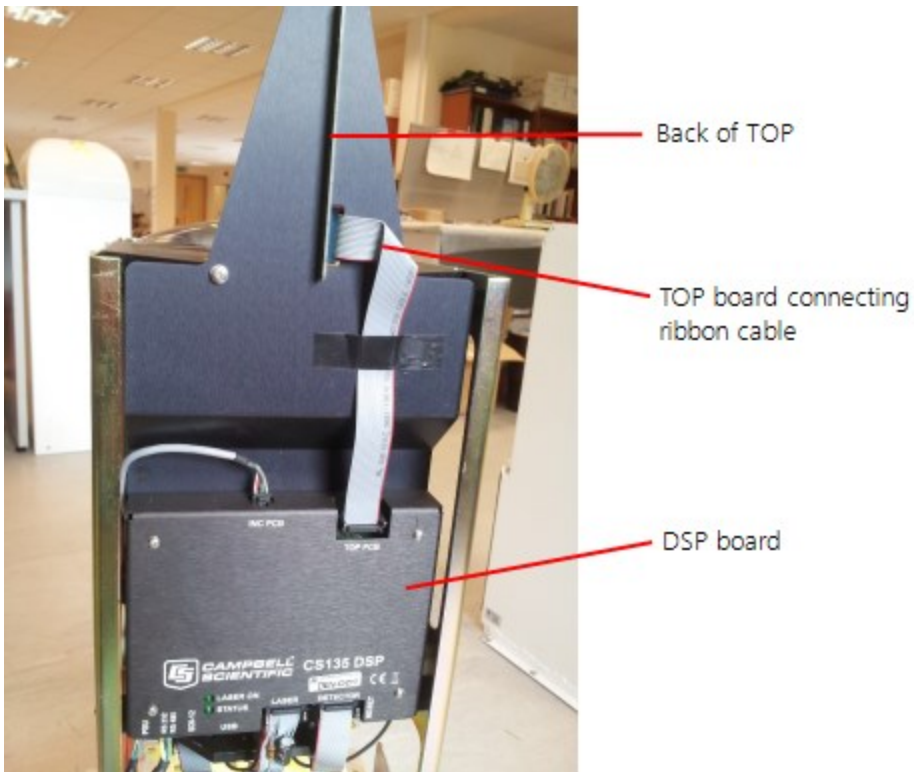

8. Disconnect the ribbon cable from the TOP board by pulling the two levers back towards the TOP board PCB as shown.

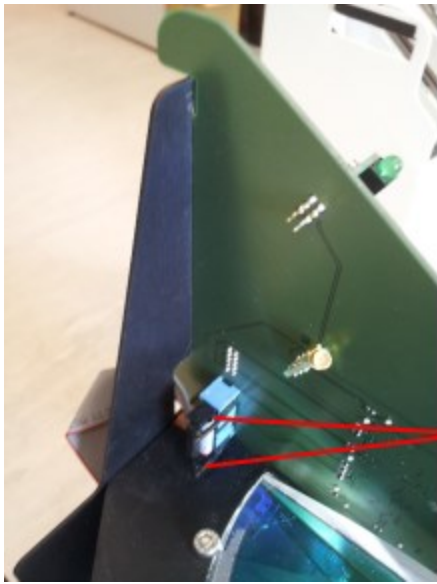

Levers to help remove ribbon connector

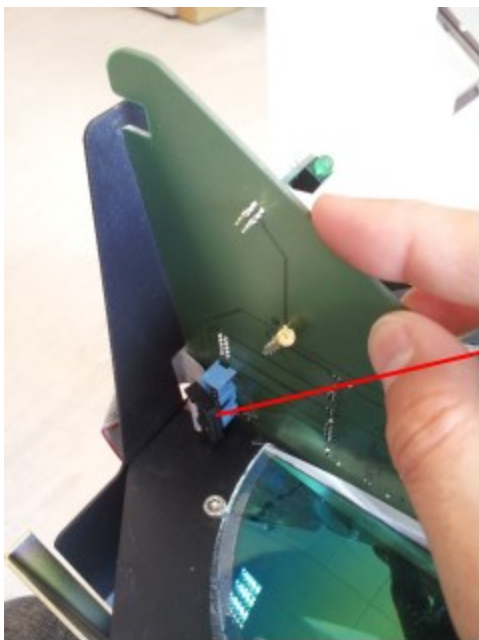

Ribbon connector removed from TOP board

9. Remove TOP board grounding wire from under screw. Keep the screw in a secure place.

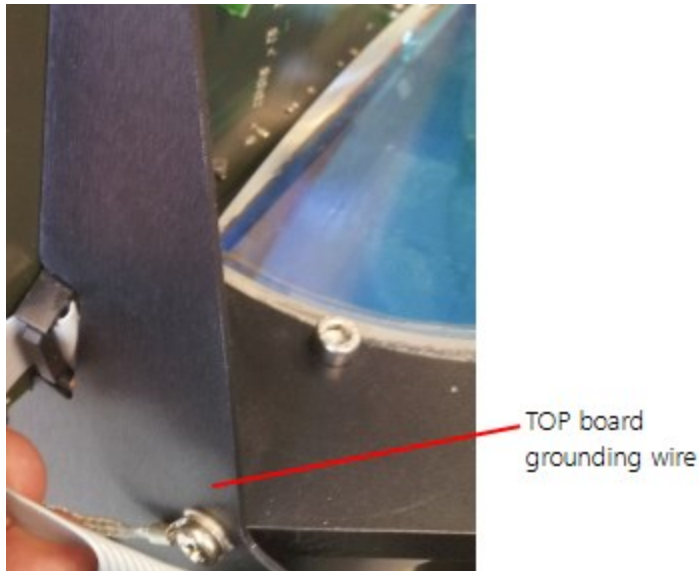

10. Observe and note the orientation and position of the rubber seal from the top edge of the board. There is a lip on the lower edge of the seal which, when reinstalled, should be on the same side of the board.
11. Remove the seal by gripping at the bottom of the lower flat sides and pulling it away from the board starting at one end. Do not pull the strip by gripping the top, soft part of the seal. The seal is not glued on, but grips the board using an internal spring. Put the strip in a secure place for reuse.

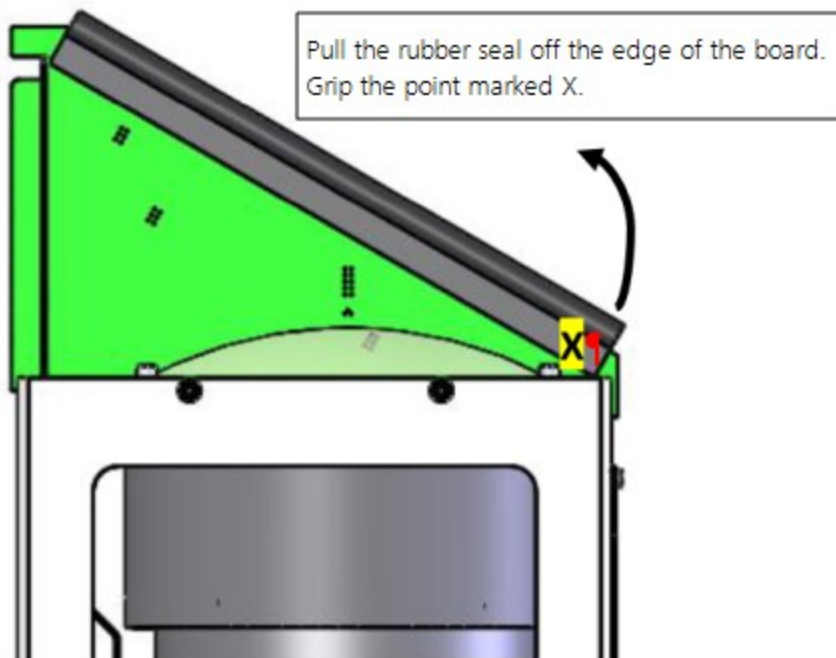

12. Remove the TOP board by pulling the black anodized aluminium plate away from the back of the board. Use your thumb to pull the plate, at the same time, push the top of the TOP board with you index finger. The TOP board should then move forward and up out of its slot. Do not lift until the top board has moved forward enough to unhook the front.

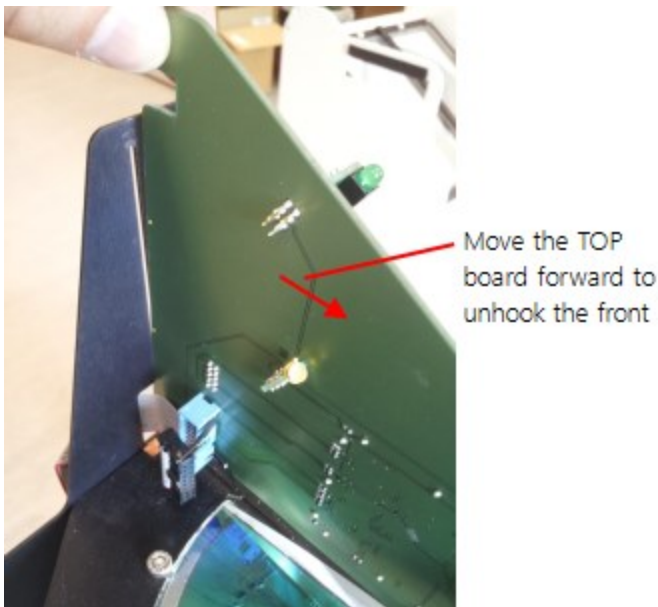
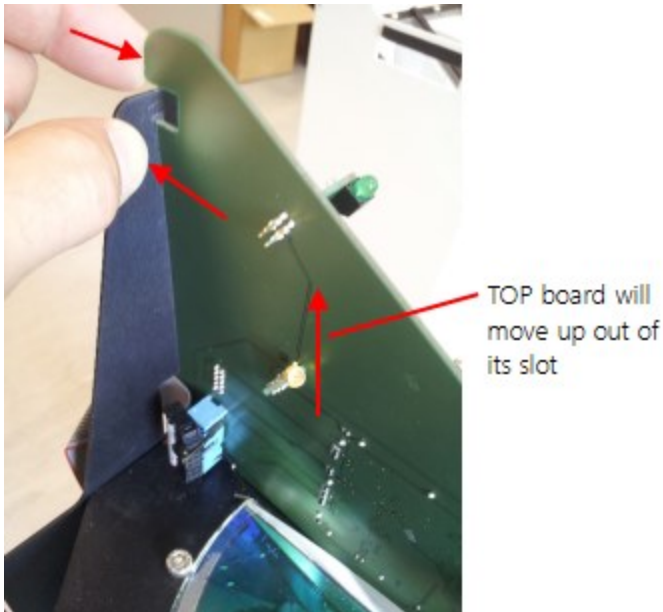

13. Carefully feed the TOP board ground cable through the ribbon cable slot.

14. Now the TOP board is completely removed.



15. To fit the new TOP board reverse the procedure above. Clip the board in the vertical aluminium plate making sure to position the ribbon cable so the connector can plug into the socket on the new board. Attach the ground wire of the new board to the back of the unit using the screw as shown in step 9 above. Then refit the rubber seal to the top edge of the board by pushing it on, starting at one end and working along to the other end. Make sure the seal is in the same orientation and position as before so it does not overhang the end of the board and the lower lip of the seal do not obscure the lens closest to the board.
16. Check that there is no dirt or grit on the silicone rubber foam seal which sits around the edge of the base plate.
17. Check for and carefully remove any dust or marks on the top lenses.
18. Refit the internal enclosure.
19. Replace the screws which hold the enclosure down to the plate and make sure they are tight enough to push enclosure edges flat to the base plate. This ensures correct seal compression.
20. Look into the top window to make sure the rubber seal on the TOP board sits beneath the central bar of the metal window frame and, as far as is visible, has formed a light tight seal between the two sides of the top circuit board. If not, remove the inner enclosure and refit the seal.
21. Reconnect the battery.
22. Replace the outer enclosure.
23. Close and secure the access door.
24. Reconnect the sensor leads then connect to the sensor using a computer or data logger and power-on the sensor. Check the SkyVUE PRO is operating correctly by observing the response to the status command or looking at the status flags in messages.

Appendix G. Self-diagnostic information

Use following procedure to get self-diagnostic information for troubleshooting the SkyVUE PRO:

1. In the **ViewPoint** terminal screen, select **Connect** and type **OPEN 0** in the command section.



2. Type STATUS.



3. After the SkyVUE PRO returns the status message, in the **Enter commands** box, type debug 1 <Enter>, debug 2 <Enter>, debug 3 <Enter>, debug 4 <Enter>, and debug 5 <Enter>.

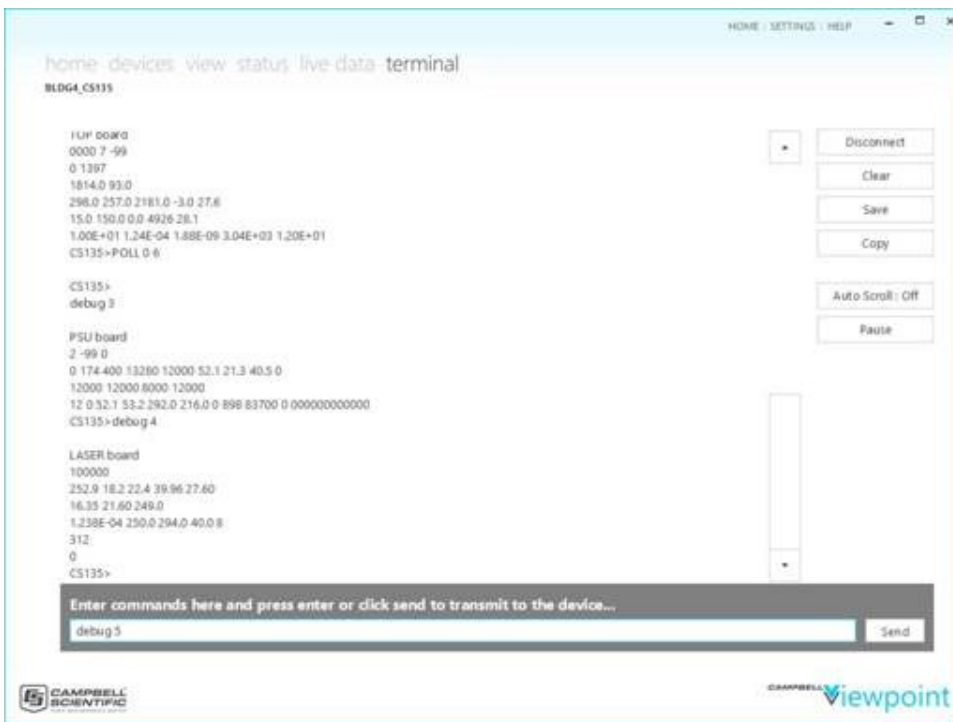

The ViewPoint screen will be similar to the following. For help in debugging the SkyVUE PRO, click the **Copy** button and paste the text in an email to a Campbell Scientific technical support engineer.

```
POLL 0 6
CS135>
Status

Identification CS135 SN E1048 ID 0
DateTime 2019/11/22 18:04:01
DSP_OS 007638-012 Jun 21 2018 07:28:22
TOP_OS 7
PSU_OS 2
WatchDog 0
Serial 0 10 0 100
Heaters 3 2 1 24
MCFG 0 6 0 0 0 0
Angle -0.2 0.3 0.4
Units 2
TRH 29.9 16.4 1.7
T 52.1 40.6 27.6 28.1 40.0 29.7
SupplyVoltages 12.4 21.4 13
HOffset 0.0
Visibility Cap 6562
LaserRunDays 312
WindowTX 97.3
bs 100.0 2.0 2.0 10 1 0
mlh 30 492 492 1.80 5.00 10.00
features MLH
Flags 0000 0000 0000
CS135> debug 1

DSP board
CS135 E1048 0
3 4
007638-012 7 2
0 10 0 100
0000 0000 0000
29.9 16.4 1.7
12.4 5.0 -5.0 3.3 13
CS135> debug 2
```

```
TOP board
0000 7 -99
0 1397
1814.0 93.0
298.0 257.0 2181.0 -3.0 27.6
15.0 150.0 0.0 4926 28.1
1.00E+01 1.24E-04 1.88E-09 3.04E+03 1.20E+01
CS135>POLL 0 6

CS135>
debug 3

PSU board
2 -99 0
0 174 400 13280 12000 52.1 21.3 40.5 0
12000 12000 8000 12000
12 0 52.1 53.2 292.0 216.0 0 898 83700 0 00000000000000
CS135>debug 4

LASER board
100000
252.9 18.2 22.4 39.96 27.60
16.35 21.60 249.0
1.238E-04 250.0 294.0 40.0 8
312
0
CS135>POLL 0 6

CS135>
debug 5

APD board
0.0 121.8 107.4 171.8 0.07837 136.9
16.8 69.8 7.8
1.221E-04 4.150E-03 4.590E-02
0.613 335.0 1000.0 20.0 20.0 0.0257
25.0 21.4 73.0 5.17E-06
31.9 16.8 95.9 4.20E-06
40.6 13.1 117.5 3.33E-06
51.8 10.3 135.6 2.80E-06
66.1 8.1 150.2 2.43E-06
84.2 6.3 162.0 2.15E-06
```

107.4 5.0 171.8 2.08E-06
136.9 3.9 179.0 2.03E-06
174.6 3.1 185.0 2.26E-06
222.6 2.4 189.7 2.34E-06
283.8 1.9 193.4 2.47E-06
361.9 1.5 196.5 2.64E-06
461.4 1.2 198.9 3.01E-06
588.3 1.0 201.0 3.18E-06
750.0 1.0 202.7 3.50E-06
956.3 1.0 204.2 3.71E-06
CS135>

Limited warranty

Products manufactured by Campbell Scientific are warranted by Campbell Scientific to be free from defects in materials and workmanship under normal use and service for two years from the date of shipment unless otherwise specified on the corresponding product webpage. See Product Details on the Ordering Information pages at www.campbellsci.com. Other manufacturer's products, that are resold by Campbell Scientific, are warranted only to the limits extended by the original manufacturer.

Refer to www.campbellsci.com/terms#warranty for more information.

CAMPBELL SCIENTIFIC EXPRESSLY DISCLAIMS AND EXCLUDES ANY IMPLIED WARRANTIES OF MERCHANTABILITY OR FITNESS FOR A PARTICULAR PURPOSE. Campbell Scientific hereby disclaims, to the fullest extent allowed by applicable law, any and all warranties and conditions with respect to the Products, whether express, implied or statutory, other than those expressly provided herein.

Assistance

Products may not be returned without prior authorization.

Products shipped to Campbell Scientific require a Returned Materials Authorization (RMA) or Repair Reference number and must be clean and uncontaminated by harmful substances, such as hazardous materials, chemicals, insects, and pests. Please complete the required forms prior to shipping equipment.

Campbell Scientific regional offices handle repairs for customers within their territories. Please see the back page for the Global Sales and Support Network or visit www.campbellsci.com/contact to determine which Campbell Scientific office serves your country.

To obtain a Returned Materials Authorization or Repair Reference number, contact your CAMPBELL SCIENTIFIC regional office. Please write the issued number clearly on the outside of the shipping container and ship as directed.

For all returns, the customer must provide a "Statement of Product Cleanliness and Decontamination" or "Declaration of Hazardous Material and Decontamination" form and comply with the requirements specified in it. The form is available from your CAMPBELL SCIENTIFIC regional office. Campbell Scientific is unable to process any returns until we receive this statement. If the statement is not received within three days of product receipt or is incomplete, the product will be returned to the customer at the customer's expense. Campbell Scientific reserves the right to refuse service on products that were exposed to contaminants that may cause health or safety concerns for our employees.

Safety

DANGER — MANY HAZARDS ARE ASSOCIATED WITH INSTALLING, USING, MAINTAINING, AND WORKING ON OR AROUND TRIPODS, TOWERS, AND ANY ATTACHMENTS TO TRIPODS AND TOWERS SUCH AS SENSORS, CROSSARMS, ENCLOSURES, ANTENNAS, ETC. FAILURE TO PROPERLY AND COMPLETELY ASSEMBLE, INSTALL, OPERATE, USE, AND MAINTAIN TRIPODS, TOWERS, AND ATTACHMENTS, AND FAILURE TO HEED WARNINGS, INCREASES THE RISK OF DEATH, ACCIDENT, SERIOUS INJURY, PROPERTY DAMAGE, AND PRODUCT FAILURE. TAKE ALL REASONABLE PRECAUTIONS TO AVOID THESE HAZARDS. CHECK WITH YOUR ORGANIZATION'S SAFETY COORDINATOR (OR POLICY) FOR PROCEDURES AND REQUIRED PROTECTIVE EQUIPMENT PRIOR TO PERFORMING ANY WORK.

Use tripods, towers, and attachments to tripods and towers only for purposes for which they are designed. Do not exceed design limits. Be familiar and comply with all instructions provided in product manuals. Manuals are available at www.campbellsci.com. You are responsible for conformance with governing codes and regulations, including safety regulations, and the integrity and location of structures or land to which towers, tripods, and any attachments are attached. Installation sites should be evaluated and approved by a qualified engineer. If questions or concerns arise regarding installation, use, or maintenance of tripods, towers, attachments, or electrical connections, consult with a licensed and qualified engineer or electrician.

General

- Protect from over-voltage.
- Protect electrical equipment from water.
- Protect from electrostatic discharge (ESD).
- Protect from lightning.
- Prior to performing site or installation work, obtain required approvals and permits. Comply with all governing structure-height regulations.
- Use only qualified personnel for installation, use, and maintenance of tripods and towers, and any attachments to tripods and towers. The use of licensed and qualified contractors is highly recommended.
- Read all applicable instructions carefully and understand procedures thoroughly before beginning work.
- Wear a **hardhat** and **eye protection**, and take **other appropriate safety precautions** while working on or around tripods and towers.
- **Do not climb** tripods or towers at any time, and prohibit climbing by other persons. Take reasonable precautions to secure tripod and tower sites from trespassers.
- Use only manufacturer recommended parts, materials, and tools.

Utility and Electrical

- **You can be killed** or sustain serious bodily injury if the tripod, tower, or attachments you are installing, constructing, using, or maintaining, or a tool, stake, or anchor, come in **contact with overhead or underground utility lines**.
- Maintain a distance of at least one-and-one-half times structure height, 6 meters (20 feet), or the distance required by applicable law, **whichever is greater**, between overhead utility lines and the structure (tripod, tower, attachments, or tools).
- Prior to performing site or installation work, inform all utility companies and have all underground utilities marked.
- Comply with all electrical codes. Electrical equipment and related grounding devices should be installed by a licensed and qualified electrician.
- Only use power sources approved for use in the country of installation to power Campbell Scientific devices.

Elevated Work and Weather

- Exercise extreme caution when performing elevated work.
- Use appropriate equipment and safety practices.
- During installation and maintenance, keep tower and tripod sites clear of un-trained or non-essential personnel. Take precautions to prevent elevated tools and objects from dropping.
- Do not perform any work in inclement weather, including wind, rain, snow, lightning, etc.

Maintenance

- Periodically (at least yearly) check for wear and damage, including corrosion, stress cracks, frayed cables, loose cable clamps, cable tightness, etc. and take necessary corrective actions.
- Periodically (at least yearly) check electrical ground connections.

Internal Battery

- Be aware of fire, explosion, and severe-burn hazards.
- Misuse or improper installation of the internal lithium battery can cause severe injury.
- Do not recharge, disassemble, heat above 100 °C (212 °F), solder directly to the cell, incinerate, or expose contents to water. Dispose of spent batteries properly.

WHILE EVERY ATTEMPT IS MADE TO EMBODY THE HIGHEST DEGREE OF SAFETY IN ALL CAMPBELL SCIENTIFIC PRODUCTS, THE CUSTOMER ASSUMES ALL RISK FROM ANY INJURY RESULTING FROM IMPROPER INSTALLATION, USE, OR MAINTENANCE OF TRIPODS, TOWERS, OR ATTACHMENTS TO TRIPODS AND TOWERS SUCH AS SENSORS, CROSSARMS, ENCLOSURES, ANTENNAS, ETC.



Global Sales & Support Network

A worldwide network to help meet your needs



Campbell Scientific regional offices

Australia

Location: Garbutt, QLD Australia
Phone: 61.7.4401.7700
Email: info@campbellsci.com.au
Website: www.campbellsci.com.au

Brazil

Location: São Paulo, SP Brazil
Phone: 11.3732.3399
Email: vendas@campbellsci.com.br
Website: www.campbellsci.com.br

Canada

Location: Edmonton, AB Canada
Phone: 780.454.2505
Email: dataloggers@campbellsci.ca
Website: www.campbellsci.ca

China

Location: Beijing, P. R. China
Phone: 86.10.6561.0080
Email: info@campbellsci.com.cn
Website: www.campbellsci.com.cn

Costa Rica

Location: San Pedro, Costa Rica
Phone: 506.2280.1564
Email: info@campbellsci.cc
Website: www.campbellsci.cc

France

Location: Vincennes, France
Phone: 0033.0.1.56.45.15.20
Email: info@campbellsci.fr
Website: www.campbellsci.fr

Germany

Location: Bremen, Germany
Phone: 49.0.421.460974.0
Email: info@campbellsci.de
Website: www.campbellsci.de

India

Location: New Delhi, DL India
Phone: 91.11.46500481.482
Email: info@campbellsci.in
Website: www.campbellsci.in

South Africa

Location: Stellenbosch, South Africa
Phone: 27.21.8809960
Email: sales@campbellsci.co.za
Website: www.campbellsci.co.za

Spain

Location: Barcelona, Spain
Phone: 34.93.2323938
Email: info@campbellsci.es
Website: www.campbellsci.es

Thailand

Location: Bangkok, Thailand
Phone: 66.2.719.3399
Email: info@campbellsci.asia
Website: www.campbellsci.asia

UK

Location: Shepshed, Loughborough,
 UK
Phone: 44.0.1509.601141
Website: sales@campbellsci.co.uk
www.campbellsci.co.uk

USA

Location: Logan, UT USA
Phone: 435.227.9120
Email: info@campbellsci.com
Website: www.campbellsci.com