

# CS310

---

## Quantum Sensor



# Table of contents

---

<b>1. Introduction</b> .....	<b>1</b>
<b>2. Precautions</b> .....	<b>1</b>
<b>3. Initial inspection</b> .....	<b>2</b>
<b>4. QuickStart</b> .....	<b>2</b>
<b>5. Overview</b> .....	<b>5</b>
<b>6. Specifications</b> .....	<b>6</b>
<b>7. Installation</b> .....	<b>7</b>
7.1 Wiring .....	7
7.2 Programming .....	8
7.2.1 Input range .....	9
7.2.2 Multiplier .....	9
7.3 Siting .....	9
7.4 Mounting procedure .....	9
7.5 Output format considerations .....	11
7.6 Spectral error .....	11
<b>8. Troubleshooting, maintenance, and calibration</b> .....	<b>13</b>
8.1 Troubleshooting .....	13
8.2 Maintenance .....	13
8.2.1 Cleaning .....	13
8.2.2 Cable replacement .....	14
8.3 Calibration .....	14
<b>9. Acknowledgments</b> .....	<b>14</b>
<b>Appendix A. Importing Short Cut code into CRBasic Editor</b> .....	<b>15</b>
<b>Appendix B. Example program</b> .....	<b>16</b>

# 1. Introduction

---

The CS310 accurately measures photosynthetic photon flux density (PPFD) in both natural and artificial light. PPFD is the number of photons in the 400 to 700 nm waveband incident per unit time on a unit surface. Typical applications include PPFD measurement over plant canopies in outdoor environments, greenhouses, and growth chambers, as well as reflected or under-canopy (transmitted) PPFD measurement in the same environments.

**NOTE:**

This manual provides information only for CRBasic data loggers. For retired Edlog data logger support, contact Campbell Scientific for assistance.

## 2. Precautions

---

- READ AND UNDERSTAND the [Safety](#) section at the back of this manual.
- Care should be taken when opening the shipping package to not damage or cut the cable jacket. If damage to the cable is suspected, contact Campbell Scientific.
- Although the CS310 is rugged, it should be handled as a precision scientific instrument.
- Keep the sensor clean. The vertical edge of the diffuser must be kept clean to maintain appropriate cosine correction.
- Clean the sensor only with water, mild detergent, or vinegar. Alcohol, organic solvents, abrasives, or strong detergents harm the acrylic materials, which will adversely affect the cosine response of the sensor.
- The black outer jacket of the cable is Santoprene® rubber. This compound was chosen for its resistance to temperature extremes, moisture, and UV degradation. However, this jacket will support combustion in air. It is rated as slow burning when tested according to U.L. 94 H.B. and will pass FMVSS302. Local fire codes may preclude its use inside buildings.

## 3. Initial inspection



---

- Upon receipt of the CS310, inspect the packaging and contents for damage. File damage claims with the shipping company.
- The model number and cable length are printed on a label at the connection end of the cable. Check this information against the shipping documents to ensure the correct product and cable length are received.

## 4. QuickStart

---

A video that describes data logger programming using *Short Cut* is available at:

[www.campbellsci.com/videos/cr1000x-datalogger-getting-started-program-part-3](http://www.campbellsci.com/videos/cr1000x-datalogger-getting-started-program-part-3) . *Short Cut* is an easy way to program your data logger to measure the sensor and assign data logger wiring terminals. *Short Cut* is available as a download on [www.campbellsci.com](http://www.campbellsci.com) . It is included in installations of *LoggerNet*, *RTDAQ*, or *PC400*.

The following procedure also describes using Short Cut to program the CS310.

1. Open *Short Cut* and click **Create New Program**.
2. Double-click the data logger model.

- In the **Available Sensors and Devices** box, type CS310, or locate the sensor in the **Sensors | Meteorological | Solar Radiation** folder. Double-click **CS310 Quantum Sensor**.

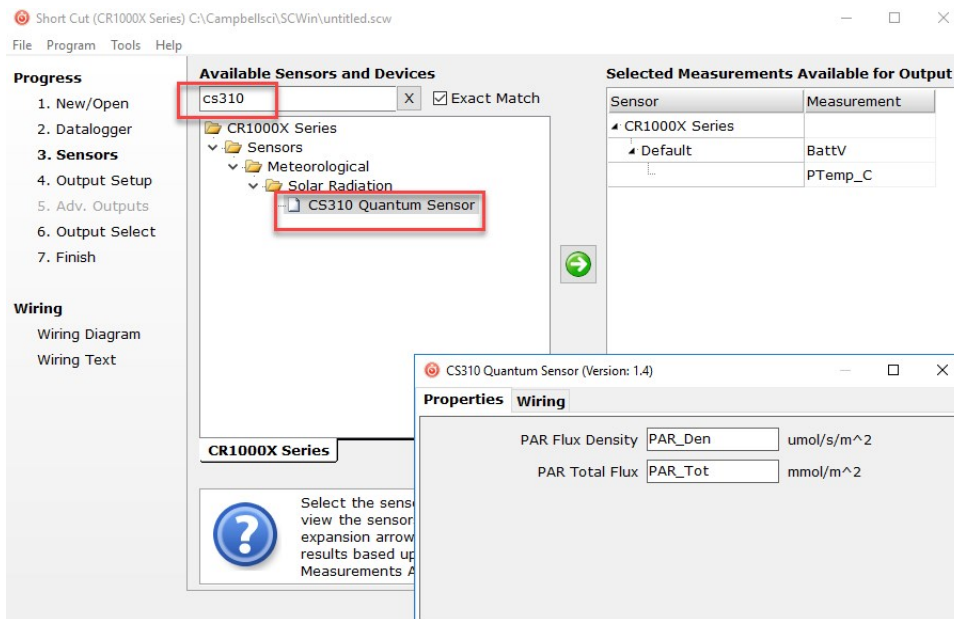

- Click the **Wiring** tab to see how the sensor is wired to the data logger. Click **OK** after wiring the sensor.

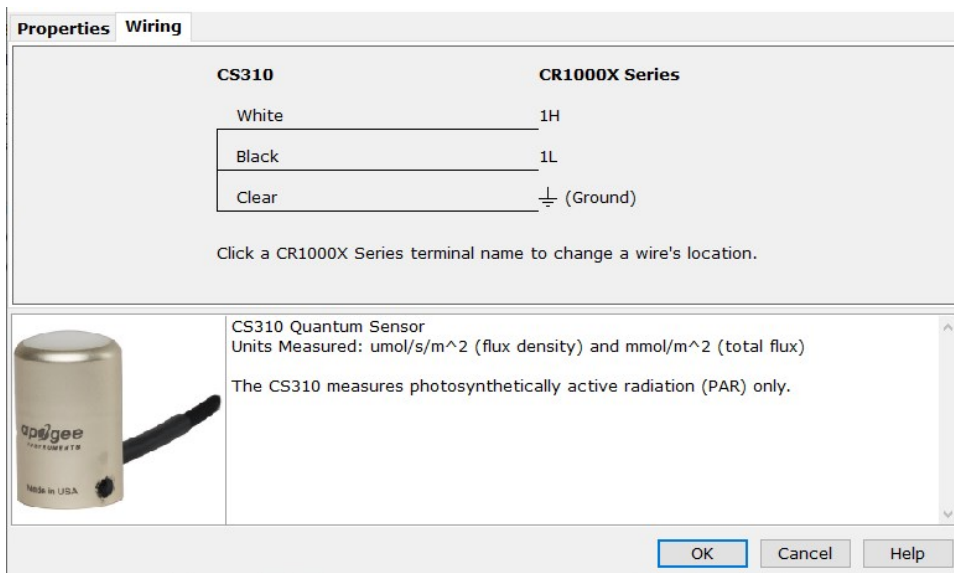

- Repeat steps three and four for other sensors.

- In **Output Setup**, type the scan rate, meaningful table names, and the **Data Output Storage Interval**.

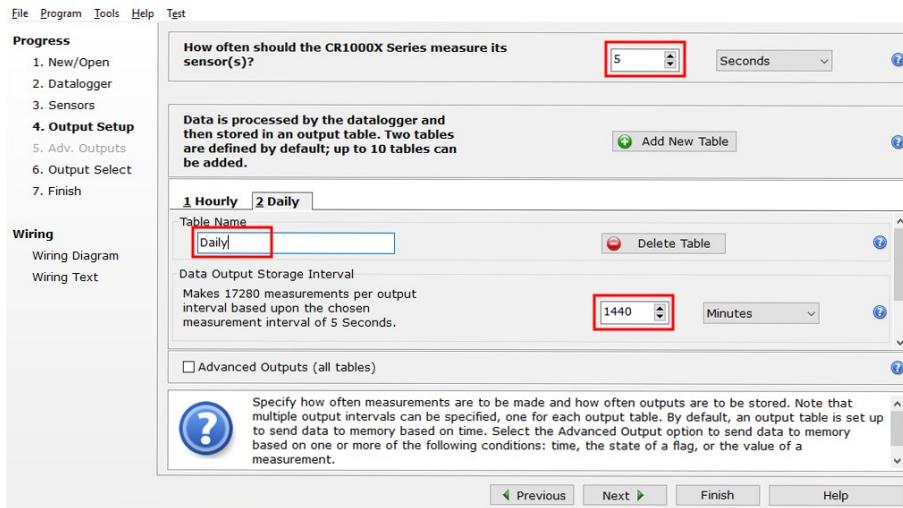

- Select the measurement and its associated output option, typically **Average** for the solar radiation measurement. Select **Total** for the PAR total measurement.

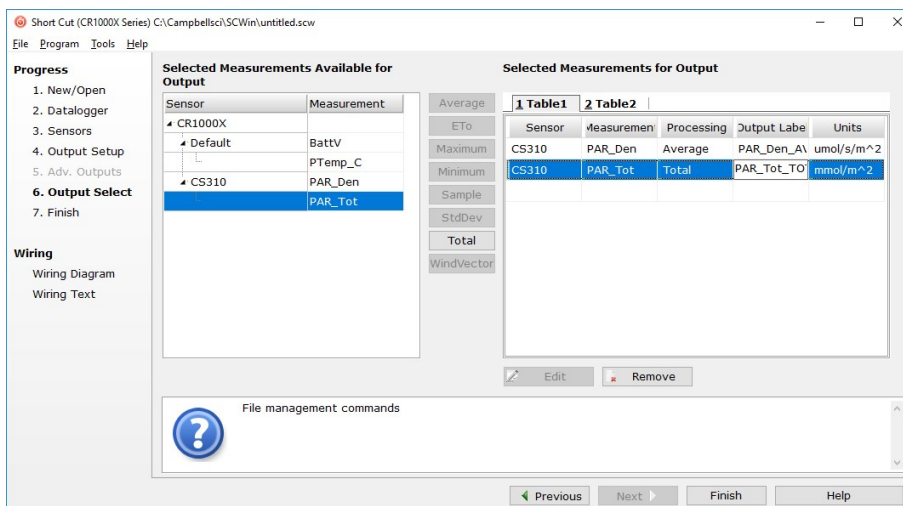

- Click **Finish** and save the program. Send the program to the data logger if the data logger is connected to the computer.
- If the sensor is connected to the data logger, check the output of the sensor in the data logger support software data display in *LoggerNet*, *RTDAQ*, or *PC400* to make sure it is making reasonable measurements.

**NOTE:**

*Short Cut* uses the execution interval to make total flux calculations (Table 7-2 [p. 9]). This needs to be taken into account while editing the *Short Cut* program.

# 5. Overview

---

The CS310 quantum sensor measures photosynthetically active radiation (PAR) in the 389 to 692 nm waveband. The unit of measurement is micromoles per second per square meter ( $\mu\text{mol}/\text{m}^2/\text{s}$ ). The CS310 can accurately measure PPFD from 0 to 4000  $\mu\text{mol}/\text{m}^2/\text{s}$ , which is a voltage range of 0 to 40 mV. In practice, the maximum PPFD in the field is about 2500  $\mu\text{mol}/\text{m}^2/\text{s}$ , so the practical (expected) voltage range is 0 to 25 mV.

The quantum sensor is designed to measure PAR received on a plane surface. The indicated sensor response (Figure 5-1 [p. 5]) is selected because it approximates the photosynthetic response of plants for which data is available. A silicon photodiode with an enhanced response in the visible wavelengths is used as the sensor. A visible band pass interference filter in combination with colored glass filters is mounted in a cosine corrected head.

Measuring PAR within plant canopies, greenhouses, controlled environment chambers, confined laboratory conditions, or at remote environmental monitoring sites are all typical applications for this sensor.

During the night, the CS310 may output a slightly negative value, caused by RF noise. Negative values may be set to zero in the data logger program.

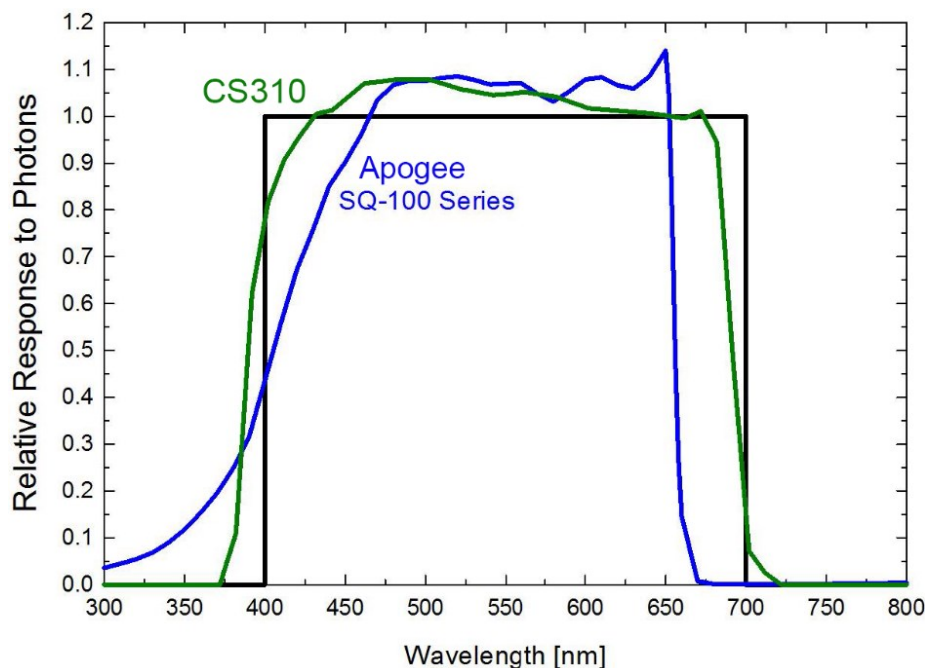

Figure 5-1. CS310 spectral response

## Features:

- Ideal applications include PPFD measurement over plant canopies in outdoor environments, greenhouses, and growth chambers, as well as reflected or under-canopy (transmitted) PPFD measurement in the same environments.
- Measures photosynthetic photon flux density (PPFD) in both natural and artificial light.
- Compatible with Campbell Scientific CRBasic data loggers: CR6, CR3000, CR1000X, CR800-series, CR300-series, CR1000

# 6. Specifications

---

<b>Stability:</b>	< $\pm 2\%$ change over a 1-year period
<b>Response time:</b>	< 1 ms
<b>Temperature dependence:</b>	$-0.11 \pm 0.04\%/^{\circ}\text{C}$
<b>Cosine response:</b>	$\pm 5\%$ at $75^{\circ}$ zenith angle
<b>Operating temperature:</b>	$-40$ to $70^{\circ}\text{C}$
<b>Relative humidity:</b>	0 to 100%
<b>Detector:</b>	High stability silicon photodiode (blue enhanced)
<b>Sensor housing:</b>	Weatherproof anodized aluminum case with acrylic diffuser
<b>IP rating:</b>	IP68
<b>Diameter:</b>	2.4 cm (0.94 in)
<b>Height:</b>	3.7 cm (1.46 in)
<b>Weight:</b>	100 g (3.53 oz) (with 5 m of wire)
<b>Calibration:</b>	$\pm 5\%$ traceable to the U.S. National Institute of Standards Technology (NIST)
<b>Measurement range:</b>	0 to $4000\ \mu\text{mol}/\text{m}^2/\text{s}$
<b>Voltage range:</b>	0 to 40 mV
<b>Sensitivity:</b>	0.01 mV per $\mu\text{mol}/\text{m}^2/\text{s}$
<b>Linearity:</b>	Less than 1% (up to $4000\ \mu\text{mol}/\text{m}^2/\text{s}$ )



**Light spectrum waveband:** 389 to 692 nm  $\pm$  5 nm (wavelengths where response is greater than 50%)

**Compliance:** View at [www.campbellsci.com/cs310](http://www.campbellsci.com/cs310) 

# 7. Installation

When programming with *Short Cut*, skip [Wiring](#) (p. 7) and [Programming](#) (p. 8). *Short Cut* does this work for you. See [QuickStart](#) (p. 2) for a *Short Cut* tutorial.

## 7.1 Wiring

A schematic diagram of the CS310 is shown in [Figure 7-1](#) (p. 7).

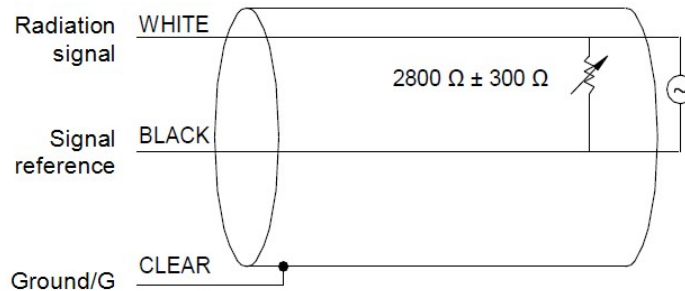

Figure 7-1. CS310 schematic

Connections to Campbell Scientific data loggers are given in [Table 7-1](#) (p. 7). When *Short Cut* is used to create the data logger program, the sensor should be wired to the terminals shown in the wiring diagram created by *Short Cut*.

Table 7-1: Wire color, function, and data logger connection			
Wire color	Wire function	Single-ended data logger terminal	Differential data logger terminal
White	Signal	U configured for single-ended analog input <sup>1</sup> or SE (single-ended, analog-voltage input)	U configured for differential high <sup>1</sup> or DIFF H (differential high, analog-voltage input)
Black	Signal reference	⊥ (analog ground)	U configured for differential low <sup>1</sup> or DIFF L (differential low, analog-voltage input)

Table 7-1: Wire color, function, and data logger connection

Wire color	Wire function	Single-ended data logger terminal	Differential data logger terminal
Clear	Shield	⏏ (analog ground)	⏏ (analog ground)

<sup>1</sup>U terminals are available on CR6 and GRANITE 6 data loggers. U terminals are automatically configured by the measurement instruction.

## 7.2 Programming

*Short Cut* is the best source for up-to-date programming code for Campbell Scientific data loggers. If your data acquisition requirements are simple, you can probably create and maintain a data logger program exclusively with *Short Cut*. If your data acquisition needs are more complex, the files that *Short Cut* creates are a great source for programming code to start a new program or add to an existing custom program.

**NOTE:**

*Short Cut* cannot edit programs after they are imported and edited in *CRBasic Editor*.

A *Short Cut* tutorial is available in [QuickStart](#) (p. 2). If you wish to import *Short Cut* code into *CRBasic Editor* to create or add to a customized program, follow the procedure in [Importing Short Cut code into CRBasic Editor](#) (p. 15). Programming basics for CRBasic data loggers are provided in the following sections. Complete program examples for select CRBasic data loggers can be found in [Example program](#) (p. 16).

Output from the CS310 is a voltage ranging from 0 to a maximum of 40 mV depending on sensor calibration and radiation level, which is measured by the data logger by using a differential or single-ended input terminal. A differential voltage measurement is recommended because it has better noise rejection than a single-ended measurement. If a differential terminal is not available, a single-ended measurement can be used.

Nearby AC power lines, electric pumps, or motors can be a source of electrical noise. If the sensor or data logger is located in an electrically noisy environment, the measurement should be made with the 60 or 50 Hz rejection integration option as shown in the example programs.

Solar radiation can be reported as an average flux density ( $\mu\text{mol}/\text{m}^2/\text{s}$ ) or daily total flux density ( $\text{mmol}/\text{m}^2$ ). The appropriate multipliers are listed in [Table 7-2](#) (p. 9).

## 7.2.1 Input range

Measurement integration time is specified in the input range parameter code. A more noise-free reading is obtained with the slow or 60 Hz rejection integration. A fast integration takes less power and allows for faster throughput.

## 7.2.2 Multiplier

The multiplier converts the millivolt reading to engineering units. Commonly used units and how to calculate the multiplier are shown in [Table 7-2](#) (p. 9).

Units	Multiplier
$\mu\text{mol}/\text{m}^2/\text{s}$	100 (flux density)
$\text{mmol}/\text{m}^2$	$0.1t$ (total fluxes)
t = data logger program execution interval in seconds	
<b>Unit conversions</b> $\mu\text{E}/\mu\text{mol}$ $(6.02 \times 10^{17} \text{ photons}/\text{m}^2/\text{s})/(\mu\text{mol}/\text{m}^2/\text{s})$	

## 7.3 Siting

The CS310 should be mounted such that no shadows or reflections are cast on it by the tripod/tower or other sensors. Mounting the CS310 on a crossarm can help avoid reflections from the tripod or tower mast. The sensor should be mounted with the cable pointing towards the nearest magnetic pole. For example, in the Northern Hemisphere, point the cable toward the North Pole.

Mounting height is not critical for the accuracy of the measurement. However, pyranometers mounted at heights of 3 m or less are easier to level and clean.

## 7.4 Mounting procedure

The CS310 mounts to a tripod or tower using the CM226 Solar Sensor Stand, which integrates leveling and mounting hardware into one mount.

**NOTE:**

You can also use a CM225 or 015ARM to mount the CS310 to a tripod or tower. However, a leveling base is required. The installation procedure for using the CM225 and 015ARM mounts is available in an older manual at [www.campbellsci.com/old-manuals](http://www.campbellsci.com/old-manuals) .

Tools required for installation on a tripod or tower:

- Tape measure
- UV-resistant wire ties
- Compass
- Step ladder

1. Mount the crossarm to the tripod or tower if using one.
2. Secure the CS310 to the CM226; see [Figure 7-2](#) (p. 10).
3. Place the screws, plate, washers, lock washers, and wing nuts in the side holes if using a vertical pipe or in the bottom holes if using a crossarm.

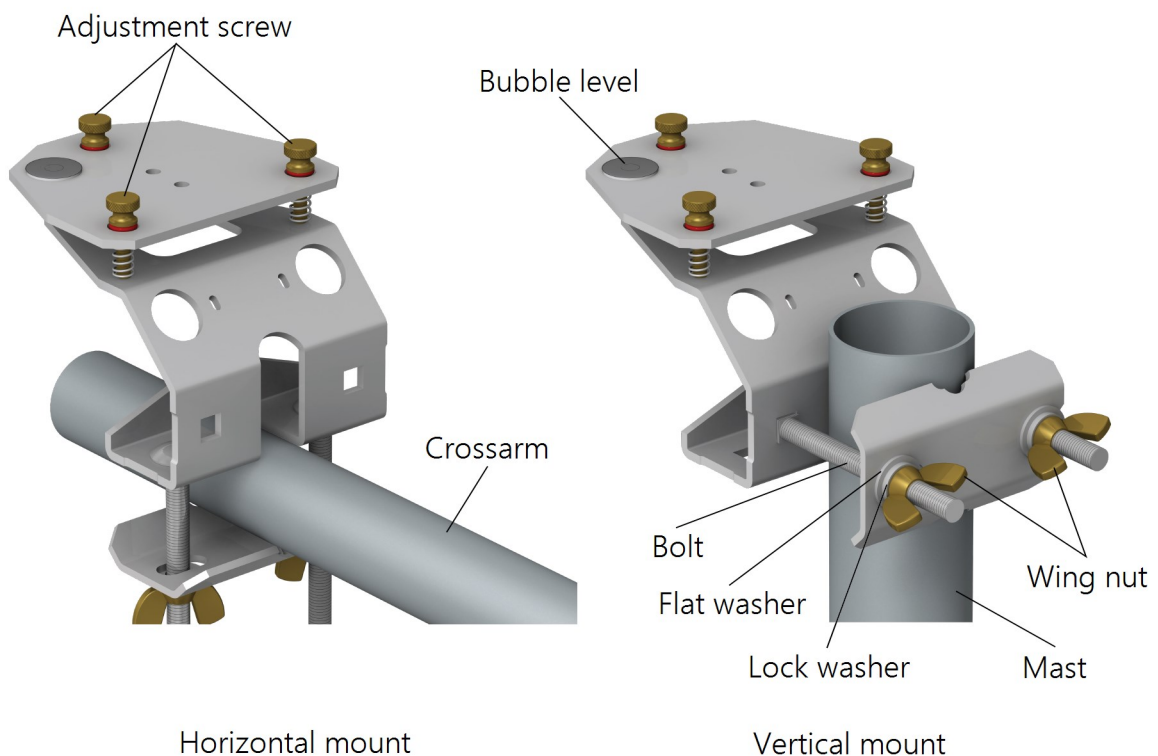

*Figure 7-2. CM226 mounted to a crossarm and mast*

4. Place the vertical pipe or crossarm between the plate and bracket, then tighten the wing nuts until the lock washers are compressed.
5. Use your fingers to turn the leveling screws as required to bring the bubble of the bubble level within the ring.
6. Tighten the mounting screws to secure the assembly in its final position. Check that the quantum sensor is still correctly leveled and adjust as necessary.
7. Route the sensor cable along the underside of the crossarm to the tripod/tower, and to the instrument enclosure.
8. Secure the cable to the crossarm and mast by using cable ties.
9. Remove the red cap after installing the sensor. Save this cap for shipping or storing the sensor.

## 7.5 Output format considerations

If solar radiation is totalized in units of  $\text{mmol}/\text{m}^2$ , there is a possibility of overranging the output limits. For CRBasic data loggers, avoid this by using the IEEE4 or long data format.

The disadvantage of the high-resolution formats is that it takes more memory per data point.

## 7.6 Spectral error

The combination of diffuser transmittance, interference filter transmittance, and photodetector sensitivity yields spectral response of a quantum sensor. A perfect photodetector, filter, and diffuser combination would exactly reproduce the defined plant photosynthetic response to photons (equal weighting to all photons between 400 and 700 nm), but this is challenging in practice. Mismatch between the defined plant photosynthetic response and sensor spectral response results in spectral error when the sensor is used to measure radiation from sources with a different spectrum than the radiation source used to calibrate the sensor (Federer and Tanner, 1966; Ross and Sulev, 2000).

Spectral errors for PPF measurements made under different radiation sources were calculated for the CS310 quantum sensor using the method of Federer and Tanner (1966). This method requires PPF weighting factors (defined plant photosynthetic response), measured sensor spectral response ([Overview](#) [p. 5]), and radiation source spectral outputs (measured with a spectroradiometer). This method calculates spectral error only and does not consider calibration, cosine, and temperature errors. Spectral error data ([Table 7-3](#) [p. 12]) indicate errors typically less than 5% for sunlight in different conditions (clear, cloudy, reflected from plant canopies, transmitted below plant canopies) and common broad spectrum electric lamps (cool white fluorescent, metal halide, high pressure sodium).

Radiation source (error calculated relative to sun, clear sky)	PPFD error [%]
Sun (clear sky)	0.0
Sun (cloudy sky)	0.5
Reflected from grass canopy	0.0
Transmitted below wheat canopy	1.1
Cool white fluorescent (T5)	2.2
Metal halide	3.1
Ceramic halide	1.9
High pressure sodium	2.2
Blue LED (448 nm peak, 20 nm full-width half-maximum)	3.0
Green LED (524 nm peak, 30 nm full-width half-maximum)	5.2
Red LED (635 nm peak, 20 nm full-width half-maximum)	0.2
Red LED (668 nm peak, 20 nm full-width half-maximum)	-1.9
Red, blue LED mixture (84% red, 16% blue)	-1.2
Red, white LED mixture (79% red, 21% white)	-0.8
Cool white fluorescent LED	2.2

Quantum sensors can be a very practical means of measuring PPF and YPF from multiple radiation sources, but spectral errors must be considered. The spectral errors in the table above can be used as correction factors for individual radiation sources.

# 8. Troubleshooting, maintenance, and calibration

---

## NOTE:

All factory repairs and recalibrations require a returned material authorization (RMA) number and completion of the “Declaration of Hazardous Material and Decontamination” form. Refer to the [Assistance](#) page at the back of this document for more information.

## 8.1 Troubleshooting

Symptom: -9999 or NAN or radiation values around 0

1. Check that the sensor is wired to the single-ended terminal specified by the measurement instruction.
2. Verify that the range code is correct for the data logger type.
3. Disconnect the sensor wires from the data logger and use a digital volt meter to check the voltage between the white (+) and the black (-) wires. No voltage indicates a problem with the photodiode, the cable, or the variable shunt resistor.

Symptom: Incorrect solar radiation

1. Make sure the top surface of the sensor head is clean and that the sensor is properly leveled.
2. Verify that the range, multiplier, and offset parameters are correct for the desired engineering units and data logger type.

## 8.2 Maintenance

### 8.2.1 Cleaning

Keep the sensor clean and treat it as a scientific instrument to maintain the accuracy of the calibration. The vertical edge of the diffuser must be kept clean to maintain appropriate cosine correction.

Clean the sensor only with water and/or a mild detergent such as dishwashing soap. Vinegar can also be used to remove hard water deposits from the diffuser element if necessary.

**CAUTION:**

Do not use alcohol, organic solvents, abrasives, or strong detergents to clean the diffuser element. Exposure to alcohol or organic solvents harm the acrylic materials of the sensor, which will adversely affect the cosine response of the sensor.

## 8.2.2 Cable replacement

Replacement cables are available from Campbell Scientific. When reconnecting your sensor, arrows on the connector jacket and an aligning notch ensure proper orientation.

When disconnecting the sensor for an extended period of time, protect the remaining half of the connector still on the station from water and dirt with electrical tape or another method.

Connectors are designed to be finger-tightened only. The O-ring inside the connector can be overly compressed if a wrench is used. Pay attention to thread alignment to avoid cross-threading. When fully tightened, one to two threads may still be visible.

## 8.3 Calibration

Recalibrate the CS310 every two years. When sending sensors in for calibration, only send the short end of the cable and half the connector. Refer to the [Assistance](#) page at the back of this document for the process of returning the quantum sensor to Campbell Scientific for recalibration.

# 9. Acknowledgments

---

Campbell Scientific, Inc. gratefully acknowledges the contribution of Apogee Instruments, Inc. to concepts, text, and images used in this manual.

Federer, C.A., and C.B. Tanner, 1966. Sensors for measuring light available for photosynthesis. *Ecology* 47:654-657.

Ross, J., and M. Sulev, 2000. Sources of errors in measurements of PAR. *Agricultural and Forest Meteorology* 100:103-125.



# Appendix A. Importing *Short Cut* code into *CRBasic Editor*

---

*Short Cut* creates a .DEF file that contains wiring information and a program file that can be imported into *CRBasic Editor*. By default, these files reside in the C:\campbellsci\SCWin folder.

Import *Short Cut* program file and wiring information into *CRBasic Editor*:

1. Create the *Short Cut* program, then save it. Click the **Advanced** tab then the **CRBasic Editor** button. Your program file will open in CRBasic with a generic name. Provide a meaningful name and save the CRBasic program. This program can now be edited for additional refinement.

**NOTE:**

Once the file is edited with *CRBasic Editor*, *Short Cut* can no longer be used to edit the program.

2. To add the *Short Cut* wiring information into the new CRBasic program, open the .DEF file located in the C:\campbellsci\SCWin folder. Copy the wiring information found at the beginning of the .DEF file.
3. Go into the CRBasic program and paste the wiring information at the beginning of the program.
4. In the CRBasic program, highlight the wiring information, right-click, and select **Comment Block**. This adds an apostrophe (') to the beginning of each of the highlighted lines, which instructs the data logger compiler to ignore those lines when compiling. The **Comment Block** feature is demonstrated at about 5:10 in the [CRBasic | Features](#) video .

# Appendix B. Example program

---

The example program measures the CS310 every 10 s, and converts the mV output to  $\mu\text{mol}/\text{m}^2/\text{s}$  and  $\text{mmol}/\text{m}^2$ . It outputs an hourly average flux ( $\mu\text{mol}/\text{m}^2/\text{s}$ ) and a daily total flux density ( $\text{mmol}/\text{m}^2$ ).

Wiring for the example is given in [Table B-1](#) (p. 16).

Color	Description	CR1000X
White	Signal	1H
Black	Signal ground	1L
Clear	Shield	⏏

## CRBasic Example 1: CR1000X program

```
'CR1000X
'Declare Variables and Units
Public BattV : Units BattV = Volts
Public PTemp_C : Units PTemp_C = Deg C
Public PAR_Den : Units PAR_Den =  $\mu\text{mol/s/m}^2$ 
Public PAR_Tot : Units PAR_Tot =  $\text{mmol/m}^2$ 

'Define Data Tables
DataTable(Hourly,True,-1)
  DataInterval(0,60,Min,10)
  Average(1,PAR_Den,FP2,False)
EndTable

DataTable(Daily,True,-1)
  DataInterval(0,1440,Min,10)
  Minimum (1,BattV,FP2,False,False)
  Maximum (1,BattV,FP2,False,False)
  Minimum (1,PTemp_C,FP2,False,False)
  Maximum (1,PTemp_C,FP2,False,False)
  Totalize(1,PAR_Tot,IEEE4,False)
EndTable

'Main Program
BeginProg
  Scan(10,Sec,1,0)
  'Default CR1000X Data Logger Battery Voltage measurement 'BattV'
  Battery (BattV)
  'Default CR1000X Data Logger Wiring Panel Temperature measurement 'PTemp_C'
  PanelTemp (PTemp_C,_60Hz)

  'CS310 Quantum Sensor measurements PAR_Tot and PAR_Den:
  VoltDiff (PAR_Den,1,AutoRange,1,False,0,60,1.0,0) 'Use AutoRange

  'Set negative values to zero
  If PAR_Den<0 Then PAR_Den=0

  'Multipliers will differ for each sensor and scan rate
  PAR_Tot=PAR_Den * 1
  PAR_Den=PAR_Den * 100

  'Call Data Tables and Store Data
  CallTable(Hourly)
  CallTable(Daily)
NextScan
EndProg
```

# Limited warranty

---

Products manufactured by Campbell Scientific are warranted by Campbell Scientific to be free from defects in materials and workmanship under normal use and service for four years from the date of shipment unless otherwise specified on the corresponding product webpage. See Product Details on the Ordering Information pages at [www.campbellsci.com](http://www.campbellsci.com). Other manufacturer's products, that are resold by Campbell Scientific, are warranted only to the limits extended by the original manufacturer.

Refer to [www.campbellsci.com/terms#warranty](http://www.campbellsci.com/terms#warranty) for more information.

**CAMPBELL SCIENTIFIC EXPRESSLY DISCLAIMS AND EXCLUDES ANY IMPLIED WARRANTIES OF MERCHANTABILITY OR FITNESS FOR A PARTICULAR PURPOSE.** Campbell Scientific hereby disclaims, to the fullest extent allowed by applicable law, any and all warranties and conditions with respect to the Products, whether express, implied or statutory, other than those expressly provided herein.

# Assistance

---

Products may not be returned without prior authorization.

Products shipped to Campbell Scientific require a Returned Materials Authorization (RMA) or Repair Reference number and must be clean and uncontaminated by harmful substances, such as hazardous materials, chemicals, insects, and pests. Please complete the required forms prior to shipping equipment.

Campbell Scientific regional offices handle repairs for customers within their territories. Please see the back page for the Global Sales and Support Network or visit [www.campbellsci.com/contact](http://www.campbellsci.com/contact)  to determine which Campbell Scientific office serves your country.

To obtain a Returned Materials Authorization or Repair Reference number, contact your CAMPBELL SCIENTIFIC regional office. Please write the issued number clearly on the outside of the shipping container and ship as directed.

For all returns, the customer must provide a "Statement of Product Cleanliness and Decontamination" or "Declaration of Hazardous Material and Decontamination" form and comply with the requirements specified in it. The form is available from your CAMPBELL SCIENTIFIC regional office. Campbell Scientific is unable to process any returns until we receive this statement. If the statement is not received within three days of product receipt or is incomplete, the product will be returned to the customer at the customer's expense. Campbell Scientific reserves the right to refuse service on products that were exposed to contaminants that may cause health or safety concerns for our employees.

# Safety

---

**DANGER** — MANY HAZARDS ARE ASSOCIATED WITH INSTALLING, USING, MAINTAINING, AND WORKING ON OR AROUND **TRIPODS, TOWERS, AND ANY ATTACHMENTS TO TRIPODS AND TOWERS SUCH AS SENSORS, CROSSARMS, ENCLOSURES, ANTENNAS, ETC.** FAILURE TO PROPERLY AND COMPLETELY ASSEMBLE, INSTALL, OPERATE, USE, AND MAINTAIN TRIPODS, TOWERS, AND ATTACHMENTS, AND FAILURE TO HEED WARNINGS, INCREASES THE RISK OF DEATH, ACCIDENT, SERIOUS INJURY, PROPERTY DAMAGE, AND PRODUCT FAILURE. TAKE ALL REASONABLE PRECAUTIONS TO AVOID THESE HAZARDS. CHECK WITH YOUR ORGANIZATION'S SAFETY COORDINATOR (OR POLICY) FOR PROCEDURES AND REQUIRED PROTECTIVE EQUIPMENT PRIOR TO PERFORMING ANY WORK.

Use tripods, towers, and attachments to tripods and towers only for purposes for which they are designed. Do not exceed design limits. Be familiar and comply with all instructions provided in product manuals. Manuals are available at [www.campbellsci.com](http://www.campbellsci.com). You are responsible for conformance with governing codes and regulations, including safety regulations, and the integrity and location of structures or land to which towers, tripods, and any attachments are attached. Installation sites should be evaluated and approved by a qualified engineer. If questions or concerns arise regarding installation, use, or maintenance of tripods, towers, attachments, or electrical connections, consult with a licensed and qualified engineer or electrician.

## General

- Protect from over-voltage.
- Protect electrical equipment from water.
- Protect from electrostatic discharge (ESD).
- Protect from lightning.
- Prior to performing site or installation work, obtain required approvals and permits. Comply with all governing structure-height regulations.
- Use only qualified personnel for installation, use, and maintenance of tripods and towers, and any attachments to tripods and towers. The use of licensed and qualified contractors is highly recommended.
- Read all applicable instructions carefully and understand procedures thoroughly before beginning work.
- Wear a **hardhat** and **eye protection**, and take **other appropriate safety precautions** while working on or around tripods and towers.
- **Do not climb** tripods or towers at any time, and prohibit climbing by other persons. Take reasonable precautions to secure tripod and tower sites from trespassers.
- Use only manufacturer recommended parts, materials, and tools.

## Utility and Electrical

- **You can be killed** or sustain serious bodily injury if the tripod, tower, or attachments you are installing, constructing, using, or maintaining, or a tool, stake, or anchor, come in **contact with overhead or underground utility lines**.
- Maintain a distance of at least one-and-one-half times structure height, 6 meters (20 feet), or the distance required by applicable law, **whichever is greater**, between overhead utility lines and the structure (tripod, tower, attachments, or tools).
- Prior to performing site or installation work, inform all utility companies and have all underground utilities marked.
- Comply with all electrical codes. Electrical equipment and related grounding devices should be installed by a licensed and qualified electrician.
- Only use power sources approved for use in the country of installation to power Campbell Scientific devices.

## Elevated Work and Weather

- Exercise extreme caution when performing elevated work.
- Use appropriate equipment and safety practices.
- During installation and maintenance, keep tower and tripod sites clear of un-trained or non-essential personnel. Take precautions to prevent elevated tools and objects from dropping.
- Do not perform any work in inclement weather, including wind, rain, snow, lightning, etc.

## Maintenance

- Periodically (at least yearly) check for wear and damage, including corrosion, stress cracks, frayed cables, loose cable clamps, cable tightness, etc. and take necessary corrective actions.
- Periodically (at least yearly) check electrical ground connections.

## Internal Battery

- Be aware of fire, explosion, and severe-burn hazards.
- Misuse or improper installation of the internal lithium battery can cause severe injury.
- Do not recharge, disassemble, heat above 100 °C (212 °F), solder directly to the cell, incinerate, or expose contents to water. Dispose of spent batteries properly.

WHILE EVERY ATTEMPT IS MADE TO EMBODY THE HIGHEST DEGREE OF SAFETY IN ALL CAMPBELL SCIENTIFIC PRODUCTS, THE CUSTOMER ASSUMES ALL RISK FROM ANY INJURY RESULTING FROM IMPROPER INSTALLATION, USE, OR MAINTENANCE OF TRIPODS, TOWERS, OR ATTACHMENTS TO TRIPODS AND TOWERS SUCH AS SENSORS, CROSSARMS, ENCLOSURES, ANTENNAS, ETC.



## Global Sales & Support Network

A worldwide network to help meet your needs



### Campbell Scientific Regional Offices

#### Australia

**Location:** Garbutt, QLD Australia  
**Phone:** 61.7.4401.7700  
**Email:** [info@campbellsci.com.au](mailto:info@campbellsci.com.au)  
**Website:** [www.campbellsci.com.au](http://www.campbellsci.com.au)

#### Brazil

**Location:** São Paulo, SP Brazil  
**Phone:** 11.3732.3399  
**Email:** [vendas@campbellsci.com.br](mailto:vendas@campbellsci.com.br)  
**Website:** [www.campbellsci.com.br](http://www.campbellsci.com.br)

#### Canada

**Location:** Edmonton, AB Canada  
**Phone:** 780.454.2505  
**Email:** [dataloggers@campbellsci.ca](mailto:dataloggers@campbellsci.ca)  
**Website:** [www.campbellsci.ca](http://www.campbellsci.ca)

#### China

**Location:** Beijing, P. R. China  
**Phone:** 86.10.6561.0080  
**Email:** [info@campbellsci.com.cn](mailto:info@campbellsci.com.cn)  
**Website:** [www.campbellsci.com.cn](http://www.campbellsci.com.cn)

#### Costa Rica

**Location:** San Pedro, Costa Rica  
**Phone:** 506.2280.1564  
**Email:** [info@campbellsci.com](mailto:info@campbellsci.com)  
**Website:** [www.campbellsci.com](http://www.campbellsci.com)

#### France

**Location:** Vincennes, France  
**Phone:** 0033.0.1.56.45.15.20  
**Email:** [info@campbellsci.fr](mailto:info@campbellsci.fr)  
**Website:** [www.campbellsci.fr](http://www.campbellsci.fr)

#### Germany

**Location:** Bremen, Germany  
**Phone:** 49.0.421.460974.0  
**Email:** [info@campbellsci.de](mailto:info@campbellsci.de)  
**Website:** [www.campbellsci.de](http://www.campbellsci.de)

#### India

**Location:** New Delhi, DL India  
**Phone:** 91.11.46500481.482  
**Email:** [info@campbellsci.in](mailto:info@campbellsci.in)  
**Website:** [www.campbellsci.in](http://www.campbellsci.in)

#### South Africa

**Location:** Stellenbosch, South Africa  
**Phone:** 27.21.8809960  
**Email:** [sales@campbellsci.co.za](mailto:sales@campbellsci.co.za)  
**Website:** [www.campbellsci.co.za](http://www.campbellsci.co.za)

#### Spain

**Location:** Barcelona, Spain  
**Phone:** 34.93.2323938  
**Email:** [info@campbellsci.es](mailto:info@campbellsci.es)  
**Website:** [www.campbellsci.es](http://www.campbellsci.es)

#### Thailand

**Location:** Bangkok, Thailand  
**Phone:** 66.2.719.3399  
**Email:** [info@campbellsci.asia](mailto:info@campbellsci.asia)  
**Website:** [www.campbellsci.asia](http://www.campbellsci.asia)

#### UK

**Location:** Shepshed, Loughborough, UK  
**Phone:** 44.0.1509.601141  
**Email:** [sales@campbellsci.co.uk](mailto:sales@campbellsci.co.uk)  
**Website:** [www.campbellsci.co.uk](http://www.campbellsci.co.uk)

#### USA

**Location:** Logan, UT USA  
**Phone:** 435.227.9120  
**Email:** [info@campbellsci.com](mailto:info@campbellsci.com)  
**Website:** [www.campbellsci.com](http://www.campbellsci.com)