

INSTRUCTION MANUAL



52202 Electrically Heated Rain and Snow Gage

Revision: 4/15



Copyright © 2010-2015
Campbell Scientific, Inc.

Limited Warranty

“Products manufactured by CSI are warranted by CSI to be free from defects in materials and workmanship under normal use and service for twelve months from the date of shipment unless otherwise specified in the corresponding product manual. (Product manuals are available for review online at www.campbellsci.com.) Products not manufactured by CSI, but that are resold by CSI, are warranted only to the limits extended by the original manufacturer. Batteries, fine-wire thermocouples, desiccant, and other consumables have no warranty. CSI’s obligation under this warranty is limited to repairing or replacing (at CSI’s option) defective Products, which shall be the sole and exclusive remedy under this warranty. The Customer assumes all costs of removing, reinstalling, and shipping defective Products to CSI. CSI will return such Products by surface carrier prepaid within the continental United States of America. To all other locations, CSI will return such Products best way CIP (port of entry) per Incoterms ® 2010. This warranty shall not apply to any Products which have been subjected to modification, misuse, neglect, improper service, accidents of nature, or shipping damage. This warranty is in lieu of all other warranties, expressed or implied. The warranty for installation services performed by CSI such as programming to customer specifications, electrical connections to Products manufactured by CSI, and Product specific training, is part of CSI’s product warranty. **CSI EXPRESSLY DISCLAIMS AND EXCLUDES ANY IMPLIED WARRANTIES OF MERCHANTABILITY OR FITNESS FOR A PARTICULAR PURPOSE. CSI hereby disclaims, to the fullest extent allowed by applicable law, any and all warranties and conditions with respect to the Products, whether express, implied or statutory, other than those expressly provided herein.”**

Assistance

Products may not be returned without prior authorization. The following contact information is for US and international customers residing in countries served by Campbell Scientific, Inc. directly. Affiliate companies handle repairs for customers within their territories. Please visit www.campbellsci.com to determine which Campbell Scientific company serves your country.

To obtain a Returned Materials Authorization (RMA), contact CAMPBELL SCIENTIFIC, INC., phone (435) 227-9000. After an application engineer determines the nature of the problem, an RMA number will be issued. Please write this number clearly on the outside of the shipping container. Campbell Scientific's shipping address is:

CAMPBELL SCIENTIFIC, INC.

RMA# _____
815 West 1800 North
Logan, Utah 84321-1784

For all returns, the customer must fill out a "Statement of Product Cleanliness and Decontamination" form and comply with the requirements specified in it. The form is available from our web site at www.campbellsci.com/repair. A completed form must be either emailed to repair@campbellsci.com or faxed to (435) 227-9106. Campbell Scientific is unable to process any returns until we receive this form. If the form is not received within three days of product receipt or is incomplete, the product will be returned to the customer at the customer's expense. Campbell Scientific reserves the right to refuse service on products that were exposed to contaminants that may cause health or safety concerns for our employees.

Precautions

DANGER — MANY HAZARDS ARE ASSOCIATED WITH INSTALLING, USING, MAINTAINING, AND WORKING ON OR AROUND TRIPODS, TOWERS, AND ANY ATTACHMENTS TO TRIPODS AND TOWERS SUCH AS SENSORS, CROSSARMS, ENCLOSURES, ANTENNAS, ETC. FAILURE TO PROPERLY AND COMPLETELY ASSEMBLE, INSTALL, OPERATE, USE, AND MAINTAIN TRIPODS, TOWERS, AND ATTACHMENTS, AND FAILURE TO HEED WARNINGS, INCREASES THE RISK OF DEATH, ACCIDENT, SERIOUS INJURY, PROPERTY DAMAGE, AND PRODUCT FAILURE. TAKE ALL REASONABLE PRECAUTIONS TO AVOID THESE HAZARDS. CHECK WITH YOUR ORGANIZATION'S SAFETY COORDINATOR (OR POLICY) FOR PROCEDURES AND REQUIRED PROTECTIVE EQUIPMENT PRIOR TO PERFORMING ANY WORK.

Use tripods, towers, and attachments to tripods and towers only for purposes for which they are designed. Do not exceed design limits. Be familiar and comply with all instructions provided in product manuals. Manuals are available at www.campbellsci.com or by telephoning (435) 227-9000 (USA). You are responsible for conformance with governing codes and regulations, including safety regulations, and the integrity and location of structures or land to which towers, tripods, and any attachments are attached. Installation sites should be evaluated and approved by a qualified engineer. If questions or concerns arise regarding installation, use, or maintenance of tripods, towers, attachments, or electrical connections, consult with a licensed and qualified engineer or electrician.

General

- Prior to performing site or installation work, obtain required approvals and permits. Comply with all governing structure-height regulations, such as those of the FAA in the USA.
- Use only qualified personnel for installation, use, and maintenance of tripods and towers, and any attachments to tripods and towers. The use of licensed and qualified contractors is highly recommended.
- Read all applicable instructions carefully and understand procedures thoroughly before beginning work.
- Wear a **hardhat** and **eye protection**, and take **other appropriate safety precautions** while working on or around tripods and towers.
- **Do not climb** tripods or towers at any time, and prohibit climbing by other persons. Take reasonable precautions to secure tripod and tower sites from trespassers.
- Use only manufacturer recommended parts, materials, and tools.

Utility and Electrical

- **You can be killed** or sustain serious bodily injury if the tripod, tower, or attachments you are installing, constructing, using, or maintaining, or a tool, stake, or anchor, come in **contact with overhead or underground utility lines**.
- Maintain a distance of at least one-and-one-half times structure height, 20 feet, or the distance required by applicable law, **whichever is greater**, between overhead utility lines and the structure (tripod, tower, attachments, or tools).
- Prior to performing site or installation work, inform all utility companies and have all underground utilities marked.
- Comply with all electrical codes. Electrical equipment and related grounding devices should be installed by a licensed and qualified electrician.

Elevated Work and Weather

- Exercise extreme caution when performing elevated work.
- Use appropriate equipment and safety practices.
- During installation and maintenance, keep tower and tripod sites clear of un-trained or non-essential personnel. Take precautions to prevent elevated tools and objects from dropping.
- Do not perform any work in inclement weather, including wind, rain, snow, lightning, etc.

Maintenance

- Periodically (at least yearly) check for wear and damage, including corrosion, stress cracks, frayed cables, loose cable clamps, cable tightness, etc. and take necessary corrective actions.
- Periodically (at least yearly) check electrical ground connections.

WHILE EVERY ATTEMPT IS MADE TO EMBODY THE HIGHEST DEGREE OF SAFETY IN ALL CAMPBELL SCIENTIFIC PRODUCTS, THE CUSTOMER ASSUMES ALL RISK FROM ANY INJURY RESULTING FROM IMPROPER INSTALLATION, USE, OR MAINTENANCE OF TRIPODS, TOWERS, OR ATTACHMENTS TO TRIPODS AND TOWERS SUCH AS SENSORS, CROSSARMS, ENCLOSURES, ANTENNAS, ETC.

Table of Contents

PDF viewers: These page numbers refer to the printed version of this document. Use the PDF reader bookmarks tab for links to specific sections.

| | |
|--|------------|
| 1. Introduction | 1 |
| 2. Cautionary Statements | 1 |
| 3. Initial Inspection | 1 |
| 4. Quickstart | 2 |
| 5. Overview | 4 |
| 5.1 Wind Screen..... | 4 |
| 6. Specifications | 5 |
| 7. Installation | 5 |
| 7.1 Siting..... | 6 |
| 7.2 Mounting..... | 6 |
| 7.3 Wiring..... | 8 |
| 7.3.1 Heater Wiring | 8 |
| 7.3.2 Wiring to the Datalogger | 8 |
| 7.4 Datalogger Programming..... | 9 |
| 8. Troubleshooting and Maintenance | 9 |
| 8.1 Maintenance..... | 10 |
| 8.2 Troubleshooting | 10 |
| 9. Attribution | 10 |
| Appendices | |
| A. Importing Short Cut Code Into a Program Editor | A-1 |
| B. Example Programs | B-1 |
| B.1 Pulse Channel Example Programs | B-1 |
| B.1.1 CR1000 Program | B-1 |
| B.1.2 CR200(X) Series Program | B-2 |
| B.1.3 CR6 Program | B-3 |
| B.2 Control Port Example..... | B-4 |

Figures

7-1. 52202 Precipitation Gage 6
7-2. The CM220 mounted to a crossarm 7
7-3. The CM216 atop a stainless-steel tripod 7

Tables

7-1. Wiring for Pulse Channel Input..... 8
7-2. Multipliers 9

52202 Electrically Heated Rain and Snow Gage

1. Introduction

The 52202, manufactured by R. M. Young, is an electrically heated tipping bucket rain gage that measures rain, snow, and other frozen precipitation. Its catchment area of 200 cm² and measurement resolution of 0.1 mm meet the recommendations of the WMO. This heated rain gage is compatible with all Campbell Scientific dataloggers, and it is used in environmental monitoring applications.

NOTE

This manual provides information only for CRBasic dataloggers. It is also compatible with most of our retired Edlog dataloggers. For Edlog datalogger support, see an older manual at www.campbellsci.com/old-manuals or contact a Campbell Scientific application engineer for assistance.

2. Cautionary Statements

- READ AND UNDERSTAND the *Precautions* section at the front of this manual.
- WARNING: Disconnect heater power before attempting to service or repair this equipment. Failure to do so may result in personal injury or death due to electrocution.
- Debris filters, funnel, and bucket reservoirs should be kept clean.
- The 52202 is a precision instrument that must be handled with care.
- The black outer jacket of the cable is Santoprene® rubber. This compound was chosen for its resistance to temperature extremes, moisture, and UV degradation. However, this jacket will support combustion in air. It is rated as slow burning when tested according to U.L. 94 H.B. and will pass FMVSS302. Local fire codes may preclude its use inside buildings.

3. Initial Inspection

- Upon receipt of the 52202, inspect the packaging and contents for damage. File damage claims with the shipping company.
- The model number and cable length are printed on a label at the connection end of the cable. Check this information against the shipping documents to ensure the correct product and cable length are received.

4. Quickstart

Short Cut is an easy way to program your datalogger to measure the 52202 and assign datalogger wiring terminals. The following procedures shows using *Short Cut* to program the 52202.

1. Install *Short Cut* by clicking on the install file icon. Get the install file from either www.campbellsci.com, the ResourceDVD, or find it in installations of *LoggerNet*, *PC200W*, *PC400*, or *RTDAQ* software.



2. The *Short Cut* installation should place a *Short Cut* icon on the desktop of your computer. To open *Short Cut*, click on this icon.



3. When *Short Cut* opens, select **New Program**.

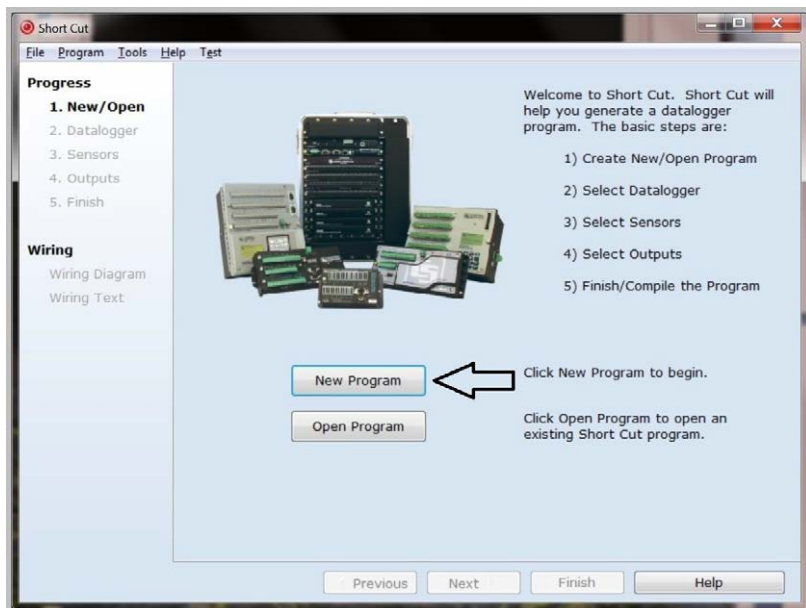

4. Select **Datalogger Model** and **Scan Interval** (default of 5 seconds is OK for most applications). Click **Next**.

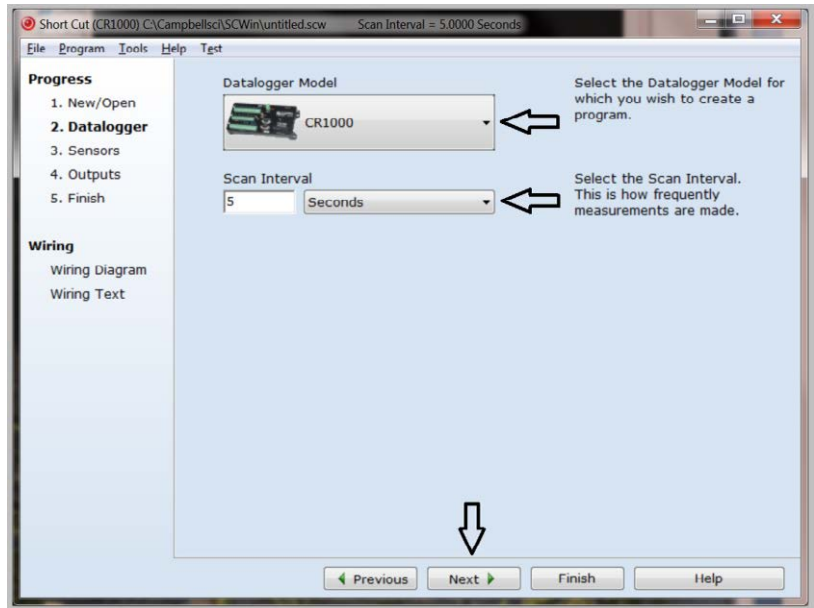

5. Under the **Available Sensors and Devices** list, select the **Sensors | Meteorological | Precipitation** folder. Select **52202 Rain Gauge**. Click  to move the selection to the **Selected** device window. Data defaults to millimeters. This can be changed by clicking the **mm** box and selecting **inch**.

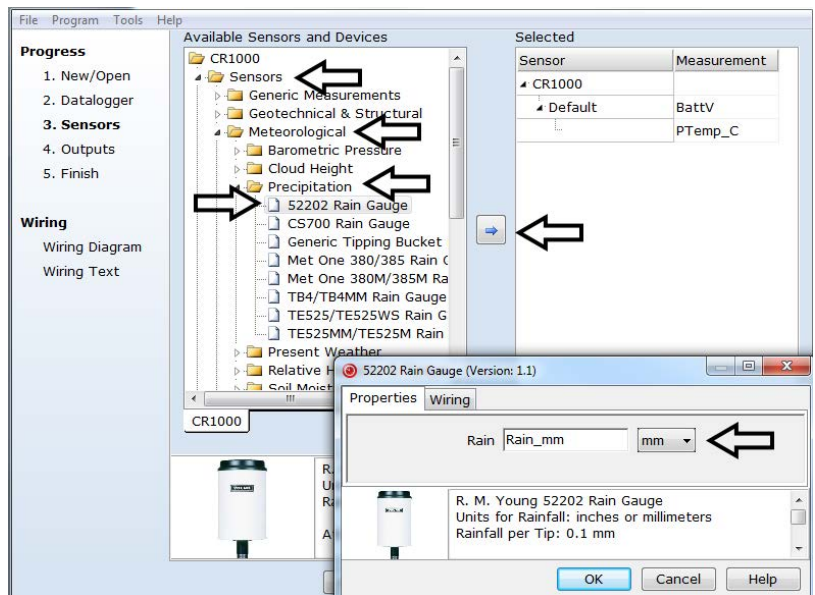

6. After selecting the sensor, click at the left of the screen on **Wiring Diagram** to see how the sensor is to be wired to the datalogger. The wiring diagram can be printed out now or after more sensors are added.

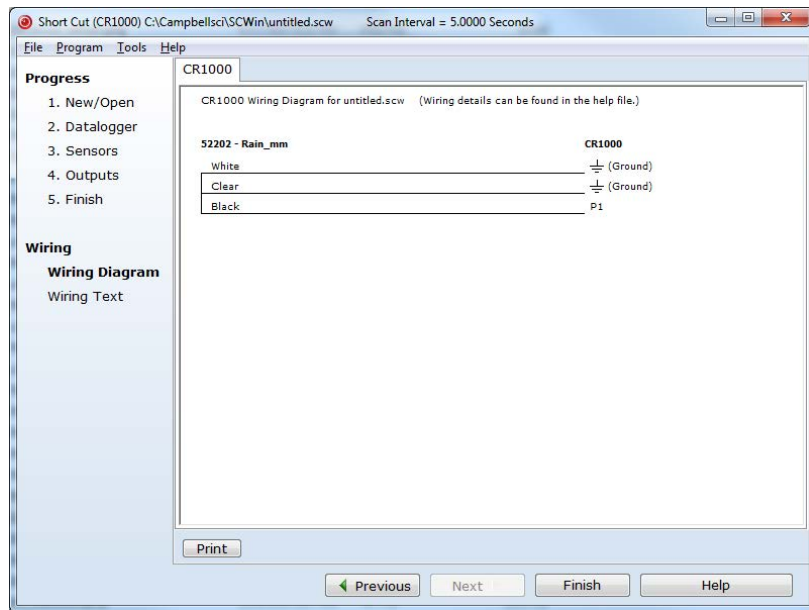

7. Select any other sensors you have, then finish the remaining *Short Cut* steps to complete the program. The remaining steps are outlined in *Short Cut Help*, which is accessed by clicking on **Help | Contents | Programming Steps**.
8. If *LoggerNet*, *PC400*, *RTDAQ*, or *PC200W* is running on your PC, and the PC to datalogger connection is active, you can click **Finish** in *Short Cut* and you will be prompted to send the program just created to the datalogger.
9. If the sensor is connected to the datalogger, as shown in the wiring diagram in step 6, check the output of the sensor in the datalogger support software data display to make sure it is making reasonable measurements.

5. Overview

The 52202 funnels precipitation into a bucket mechanism that tips when filled to the calibrated level. Each tip is marked by a magnetic reed switch closure that is recorded by a Campbell Scientific datalogger pulse count channel.

The 52202 has an internal heater that melts snow or other frozen precipitation. This heater is thermostat controlled and requires a reliable source of 24 Vac power. A wall transformer is shipped with the 52202 that plugs into a wall socket to provide the required 24 Vac power.

5.1 Wind Screen

Campbell Scientific offers the 260-953 Wind Screen to help minimize the effect of wind on rain measurements. This wind screen consists of 32 freely hanging leaves that swing as wind moves past them. Refer to the 260-953 manual for siting information and the installation procedure.

6. Specifications

Features:

- High precision—tips at 0.1 mm increments
- Heating element melts snow and ice for year-round measurement
- Compatible with Campbell Scientific CRBasic dataloggers: CR6, CR200(X) series, CR800, CR850, CR1000, CR3000, CR5000, and CR9000(X)

| | |
|-------------------------------------|---|
| Sensor Type: | Tipping bucket with magnetic reed switch, normally open |
| Accuracy: | 2% up to 25 mm h ⁻¹ (1 in h ⁻¹); 3% up to 50 mm h ⁻¹ (2 in h ⁻¹) |
| Resolution: | 0.1 mm (0.004 in) |
| Orifice Diameter: | 16 cm (6.3 in) |
| Catchment Area: | 31 in ² (200 cm ²) |
| Temperature Range: | -20 to 50 °C (heated) |
| Humidity Range: | 0 to 100% |
| Power: | 18 W @ 24 Vac |
| Contact Rating: | 24 Vac/dc, 400 mA maximum |
| Heater Thermostat Set Point: | 10 °C ± 3 °C |
| Sensor Diameter: | 18.5 cm (7.3 in) |
| Height: | 30 cm (11.8 in) |
| Mounting: | Standard 1 inch pipe size, 34 mm (1.34 in) outer diameter |

7. Installation

NOTE

The 260-953 Alter-Type Wind Screen's siting information and installation procedure are provided in the 260-953 manual.

If you are programming your datalogger with *Short Cut*, skip Section 7.3, *Wiring* (p. 8), and Section 7.4, *Datalogger Programming* (p. 9). *Short Cut* does this work for you. See Section 4, *Quickstart* (p. 2), for a *Short Cut* tutorial.

7.1 Siting

The 52202 should be mounted in a relatively level spot which is representative of the surrounding area. The lip of the funnel should be horizontal and at least 30 cm above the ground. It should be high enough to be above the average snow depth. The ground surface around the rain gage should be natural vegetation or gravel. It should not be paved.

The gage should be placed away from objects that obstruct the wind. The distance should be two to four times the height of the obstruction.

7.2 Mounting

The 52202 precipitation gage uses a clamp to fasten onto the 3659 12-inch-long, aluminum pipe or to a user-supplied 1-inch IPS pipe (see FIGURE 7-1). The 3659 pipe is shipped with the 52202 gage.

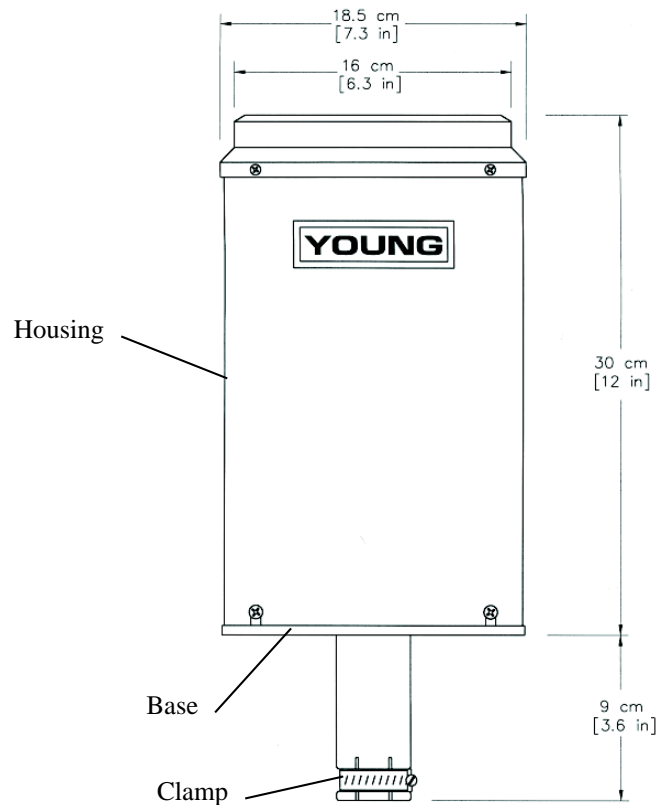

FIGURE 7-1. 52202 Precipitation Gage

The pipe attaches to a CM202, CM204, or CM206 crossarm via a CM220 Right Angle Mounting Bracket (see FIGURE 7-2). The crossarm attaches to a tripod mast, tower leg, CM300-series mounting pole, or a user-supplied vertical pipe (1.0-inch to 2.1-inch OD).

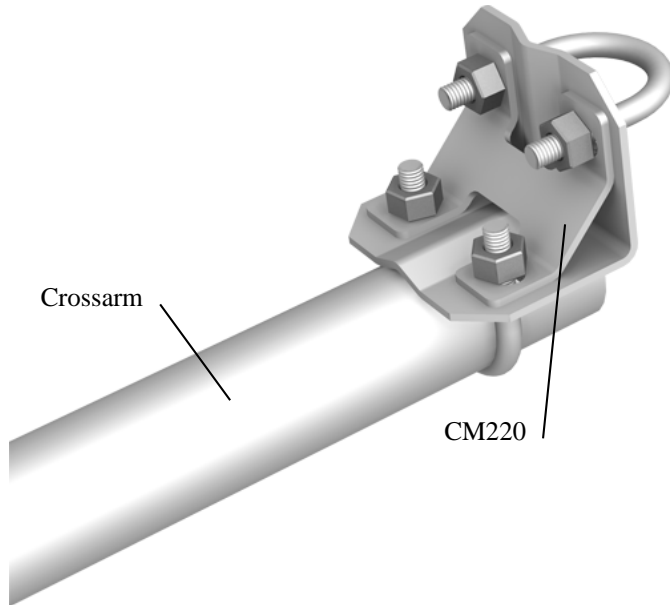

FIGURE 7-2. The CM220 mounted to a crossarm

Alternatively, the 3659 pipe can be attached to the top of our stainless-steel tripods via the CM216 Sensor Mounting Kit. The CM216 extends 4 inches above the mast of a stainless-steel CM110, CM115, or CM120 tripod (see FIGURE 7-3).

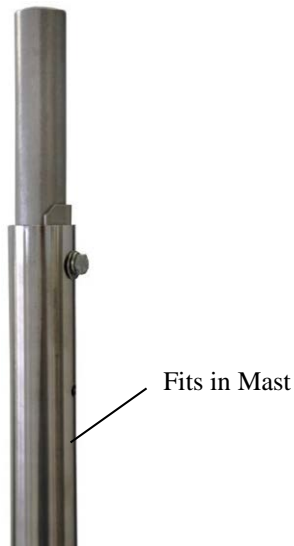

FIGURE 7-3. The CM216 atop a stainless-steel tripod

After mounting the 52202, level the gage and remove the shipping retainer by performing the following procedure:

1. Loosen the three screws that retain housing to base assembly (see FIGURE 7-1). Carefully lift housing free of base.
2. Remove shipping retainer from bucket. Verify that bucket tips freely.
3. Adjust leveling screws until bullseye level is centered.
4. Replace housing and retighten screws.

7.3 Wiring

WARNING

Disconnect heater power before attempting to service or repair this equipment. Failure to do so may result in personal injury or death due to electrocution.

7.3.1 Heater Wiring

Attach the power plug supplied with the 52202 by following the instructions supplied with the plug. This gage requires an adequately grounded, reliable source of 24 Vac power.

7.3.2 Wiring to the Datalogger

NOTE

When *Short Cut* software is used to generate the datalogger program, the sensor should be wired to the channels shown on the wiring diagram created by *Short Cut*.

The 52202 is wired to a datalogger as shown in TABLE 7-1.

| Wire Color | Wire Function | Datalogger Connection Terminal for Pulse Channel Input | Datalogger Connection Terminal for Control Port Input* |
|------------|---------------|--|--|
| Black | Signal | P, P_SW, or U (pulse channel) | C (control port) |
| White | Signal Return | ⊥ or AG (analog ground) | 5 V (on datalogger) |
| Clear | Shield | ⊥ or AG (analog ground) | ⊥ or AG (analog ground) |

*Dataloggers capable of measuring pulse counts on their control ports include CR800-series, CR1000, and CR3000.

7.4 Datalogger Programming

Short Cut is the best source for up-to-date datalogger programming code. Programming code is needed,

- when creating a program for a new datalogger installation
- when adding sensors to an existing datalogger program

If your data acquisition requirements are simple and you are connecting the sensor to a pulse port, you can probably create and maintain a datalogger program exclusively with *Short Cut*. If your data acquisition needs are more complex, the files that *Short Cut* creates are a great source for programming code to start a new program or add to an existing custom program.

NOTE

Short Cut cannot edit programs after they are imported and edited in *CRBasic Editor*.

A *Short Cut* tutorial is available in Section 4, *Quickstart* (p. 2). If you wish to import *Short Cut* code into *CRBasic Editor* to create or add to a customized program, follow the procedure in Appendix A, *Importing Short Cut Code Into a Program Editor* (p. A-1). Programming basics for CRBasic dataloggers are provided in the following sections. Complete program examples for select CRBasic dataloggers can be found in Appendix B, *Example Programs* (p. B-1). Programming basics and programming examples for Edlog dataloggers are provided at www.campbellsci.com/old-manuals.

The **PulseCount()** instruction programs CRBasic dataloggers (CR200(X), CR6, CR800, CR850, CR1000, CR3000, CR5000, CR9000(X)) to measure the 52202 rain gage.

PulseCount(Dest,Reps,PChan,PConfig,POption,Mult,Offset)

- Choose Switch Closure (code 2) for the **PConfig** parameter.
- The **Multiplier** parameter determines the units in which rainfall is reported (TABLE 7-2).

| Unit | Multiplier |
|------|------------|
| 1 in | 0.00394 |
| 1 mm | 0.1 |

8. Troubleshooting and Maintenance

NOTE

All factory repairs and recalibrations require a returned material authorization (RMA) and completion of the “Declaration of Hazardous Material and Decontamination” form. Refer to the [Assistance](#) page at the beginning of this manual for more information.

8.1 Maintenance

The rain gage should be inspected periodically. Accumulated dirt and debris should be cleaned from funnel, screen and bucket assembly. Electrical connections should be inspected and cleaned. Leveling screws may be readjusted at this time.

Periodic recalibration may be desirable to ensure measurement accuracy. The following calibration check is advised every 12 months.

1. With the rain gage properly leveled, slowly pour a measured volume of water into the collection funnel. The rate should be about 10 ml per minute which is approximately 1 inch per hour. The bucket should tip five times for each 10 ml of water. For example, 100 ml should give a count of 50 ± 1 . Bucket tips may be counted manually or with a counter connected to the rain gage terminals.
2. If the count shows an error of more than 2%, adjust the calibrating screws to correct the error. Raise the screws if the count is low, lower the screws if the count is high. Always adjust both screws equally.

8.2 Troubleshooting

Symptom: No Precipitation

1. Check that the sensor is wired to the pulse channel or control port specified by the pulse count instruction.
2. Verify that the Configuration Code (Switch Closure), and Multiplier and Offset parameters for the Pulse Count instruction are correct for the datalogger type.
3. Disconnect the sensor from the datalogger and use an ohm meter to do a continuity check of the switch. The resistance measured at the terminal block on the inside of the bucket between the black and white leads should vary from infinite (switch open) when the bucket is tipped, to less than an ohm when the bucket is balanced.

9. Attribution

Santoprene® is a registered trademark of Exxon Mobile Corporation.

Appendix A. Importing Short Cut Code Into a Program Editor

This tutorial shows:

- How to import a *Short Cut* program into a program editor for additional refinement.
- How to import a wiring diagram from *Short Cut* into the comments of a custom program.

Short Cut creates files that can be imported into *CRBasic Editor*. These files normally reside in the C:\campbellsci\SCWin folder and have the following extensions:

- .DEF (wiring and memory usage information)
- .CR2 (CR200(X) datalogger code)
- .CR6 (CR6 datalogger code)
- .CR1 (CR1000 datalogger code)
- .CR8 (CR800 or CR850 datalogger code)
- .CR3 (CR3000 datalogger code)
- .CR5 (CR5000 datalogger code)

Use the following procedure to import *Short Cut* code into *CRBasic Editor* (CR200(X), CR6, CR1000, CR800, CR850, CR3000, CR5000 dataloggers).

1. Create the *Short Cut* program following the procedure in Section 4, *Quickstart* (p. 2). Finish the program and exit *Short Cut*. Make note of the file name used when saving the *Short Cut* program.
2. Open *CRBasic Editor*.
3. Click **File | Open**. Assuming the default paths were used when *Short Cut* was installed, navigate to C:\CampbellSci\SCWin folder. The file of interest has a “.CR2”, “.CR6”, “.CR1”, “.CR8”, “.CR3”, or “.CR5” extension, for CR200(X), CR6, CR1000, CR800/CR850, CR3000, or CR5000 dataloggers, respectively. Select the file and click **Open**.
4. Immediately save the file in a folder different from \Campbellsci\SCWin, or save the file with a different file name.

NOTE

Once the file is edited with *CRBasic Editor*, *Short Cut* can no longer be used to edit the datalogger program. Change the name of the program file or move it, or *Short Cut* may overwrite it next time it is used.

5. The program can now be edited, saved, and sent to the datalogger.
6. Import wiring information to the program by opening the associated .DEF file. Copy and paste the section beginning with heading “-Wiring for CRXXX-” into the *CRBasic* program, usually at the head of the file. After pasting, edit the information such that a ' character (single quotation

mark) begins each line. This character instructs the datalogger compiler to ignore the line when compiling the datalogger code.

Appendix B. Example Programs

B.1 Pulse Channel Example Programs

The following example programs use a pulse channel to read the output from the precipitation gage. The CR1000 example will also work with the CR800, CR850, CR3000, and CR5000. CR9000(X) programming is similar to the CR1000 except it has an additional parameter in the **PulseCount()** instruction to specify the pulse module's slot.

B.1.1 CR1000 Program

```
'CR1000
'RM_Young Tipping Blk > P1
'                               Wht > ground
'Cabling for heater goes to 24VAC power supply

Public Rain_mm
Units Rain_mm=mm
DataTable(Rain,True,-1)
  DataInterval(0,60,Min,0)
  Totalize(1,Rain_mm,FP2,0)
EndTable

BeginProg
  Scan(1,Sec,1,0)
  PulseCount(Rain_mm,1,1,2,0,0.1,0)
  CallTable(Rain)
  NextScan
EndProg
```

B.1.2 CR200(X) Series Program

```
'CR200(X) Series
'RM_Young Tipping Blk > P_SW
'      Wht > ground
'Cabling for heater goes to 24VAC power supply

'Declare Variables and Units

Public Rain_mm

Units Rain_mm=mm

'Define Data Tables
DataTable(Rain,True,-1)
  DataInterval(0,60,Min)
  Totalize(1,Rain_mm,0)
EndTable

'Main Program
BeginProg
  Scan(1,Sec)

  '52202 Rain Gage measurement Rain_mm:
  PulseCount(Rain_mm,P_SW,2,0,0.1,0)

  'Call Data Tables and Store Data
  CallTable(Rain)
NextScan
EndProg
```

B.1.3 CR6 Program

```

'CR6 Series

'Declare Variables and Units
Public BattV
Public PTemp_C
Public Rain_mm

Units BattV=Volts
Units PTemp_C=Deg C
Units Rain_mm=mm

'Define Data Tables
DataTable(Table1,True,-1)
  DataInterval(0,60,Min,10)
  Totalize(1,Rain_mm,FP2,False)
EndTable

DataTable(Table2,True,-1)
  DataInterval(0,1440,Min,10)
  Minimum(1,BattV,FP2,False,False)
EndTable

'Main Program
BeginProg
  'Main Scan
  Scan(5,Sec,1,0)
  'Default Datalogger Battery Voltage measurement 'BattV'
  Battery(BattV)
  'Default Wiring Panel Temperature measurement 'PTemp_C'
  PanelTemp(PTemp_C,60)

  '52202 Rain Gauge measurement 'Rain_mm'
  PulseCount(Rain_mm,1,U1,1,0,0.1,0)

  'Call Data Tables and Store Data
  CallTable Table1
  CallTable Table2
NextScan
EndProg

```

B.2 Control Port Example

The following example program uses a control port to read the output from the precipitation gage. The CR1000 example will also work with the CR800, CR850, and CR3000.

```
'CR1000
'RM_Young Tipping Blk > C4
'
'      Wht > 5v
'Cabling for heater goes to 24VAC power supply

'Declare Variables and Units
Public BattV
Public RM_Young

Units BattV = Volts
Units RM_Young =inch

DataTable(OneMin,True,-1)
  DataInterval(0,1,Min,10)
  Totalize (1,RM_Young,FP2,False)
EndTable

'Define Data Tables
DataTable(OneDay,True,-1)
DataInterval(0,1440,Min,10)
  Minimum(1,BattV,FP2,False,False)
  Totalize (1,RM_Young,FP2,False) 'RM Young tipping bucket
EndTable

'Main Program
BeginProg
  Scan(5,Sec,1,0)
  'Default Datalogger Battery Voltage measurement BattV
  PanelTemp (PTemp,_60Hz)
  Battery(BattV)

  'RM Young Heated Rain Gage measurement Rain_in
  PulseCount(RM_Young,1,14,2,0,0.0039,0)

  'Call Data Tables and Store Data
  CallTable(OneMin)
  CallTable(OneDay)
NextScan
EndProg
```

Campbell Scientific Companies

Campbell Scientific, Inc. (CSI)

815 West 1800 North
Logan, Utah 84321
UNITED STATES

www.campbellsci.com • info@campbellsci.com

Campbell Scientific Africa Pty. Ltd. (CSAf)

PO Box 2450
Somerset West 7129
SOUTH AFRICA

www.csafrica.co.za • cleroux@csafrica.co.za

Campbell Scientific Australia Pty. Ltd. (CSA)

PO Box 8108
Garbutt Post Shop QLD 4814
AUSTRALIA

www.campbellsci.com.au • info@campbellsci.com.au

Campbell Scientific (Beijing) Co., Ltd.

8B16, Floor 8 Tower B, Hanwei Plaza
7 Guanghua Road
Chaoyang, Beijing 100004
P.R. CHINA

www.campbellsci.com • info@campbellsci.com.cn

Campbell Scientific do Brasil Ltda. (CSB)

Rua Apinagés, nbr. 2018 — Perdizes
CEP: 01258-00 — São Paulo — SP
BRASIL

www.campbellsci.com.br • vendas@campbellsci.com.br

Campbell Scientific Canada Corp. (CSC)

14532 – 131 Avenue NW
Edmonton AB T5L 4X4
CANADA

www.campbellsci.ca • dataloggers@campbellsci.ca

Campbell Scientific Centro Caribe S.A. (CSCC)

300 N Cementerio, Edificio Breller
Santo Domingo, Heredia 40305
COSTA RICA

www.campbellsci.cc • info@campbellsci.cc

Campbell Scientific Ltd. (CSL)

Campbell Park
80 Hathern Road
Shepshed, Loughborough LE12 9GX
UNITED KINGDOM

www.campbellsci.co.uk • sales@campbellsci.co.uk

Campbell Scientific Ltd. (CSL France)

3 Avenue de la Division Leclerc
92160 ANTONY
FRANCE

www.campbellsci.fr • info@campbellsci.fr

Campbell Scientific Ltd. (CSL Germany)

Fahrenheitstraße 13
28359 Bremen
GERMANY

www.campbellsci.de • info@campbellsci.de

Campbell Scientific Spain, S. L. (CSL Spain)

Avda. Pompeu Fabra 7-9, local 1
08024 Barcelona
SPAIN

www.campbellsci.es • info@campbellsci.es

Please visit www.campbellsci.com to obtain contact information for your local US or international representative.